

1

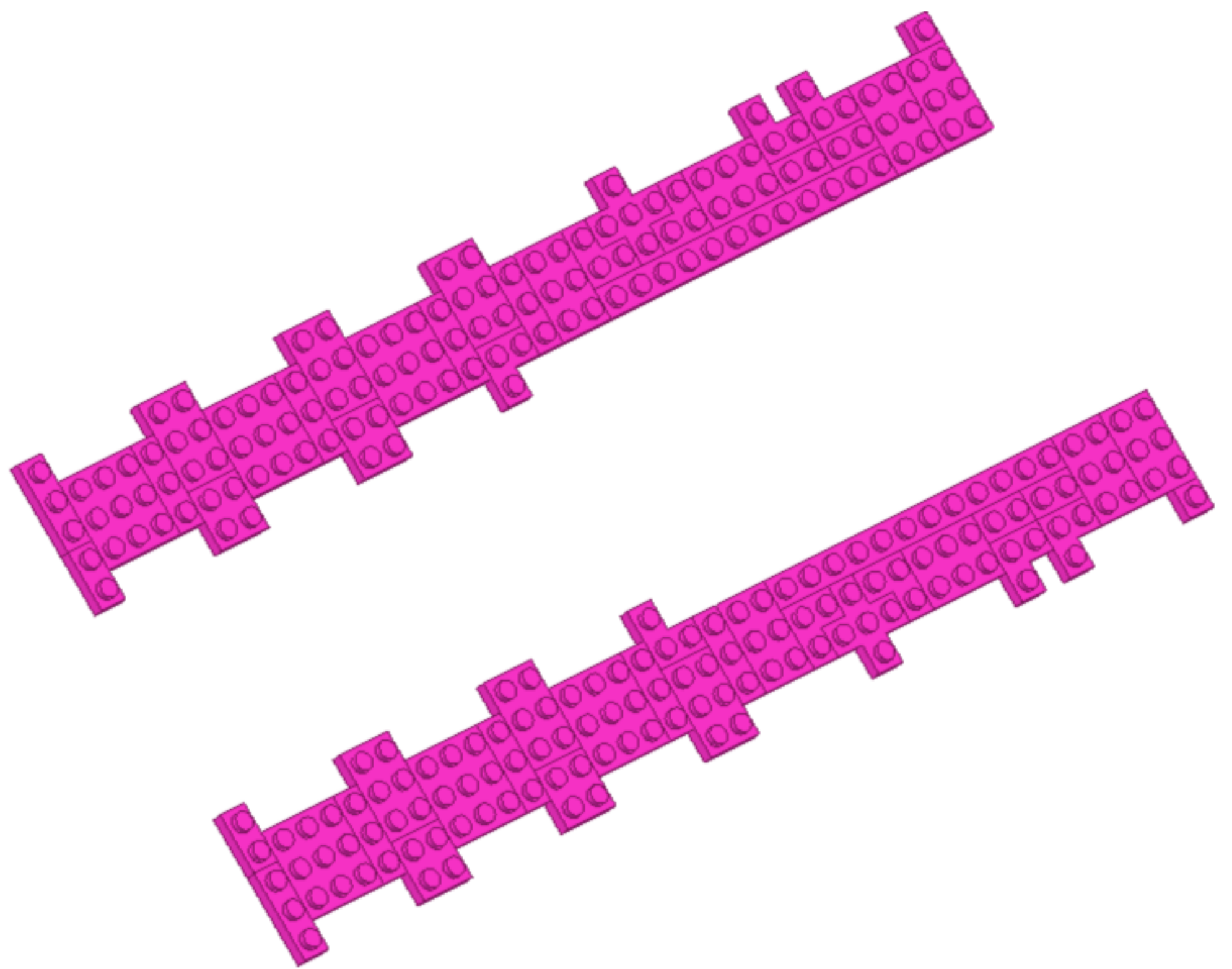

2

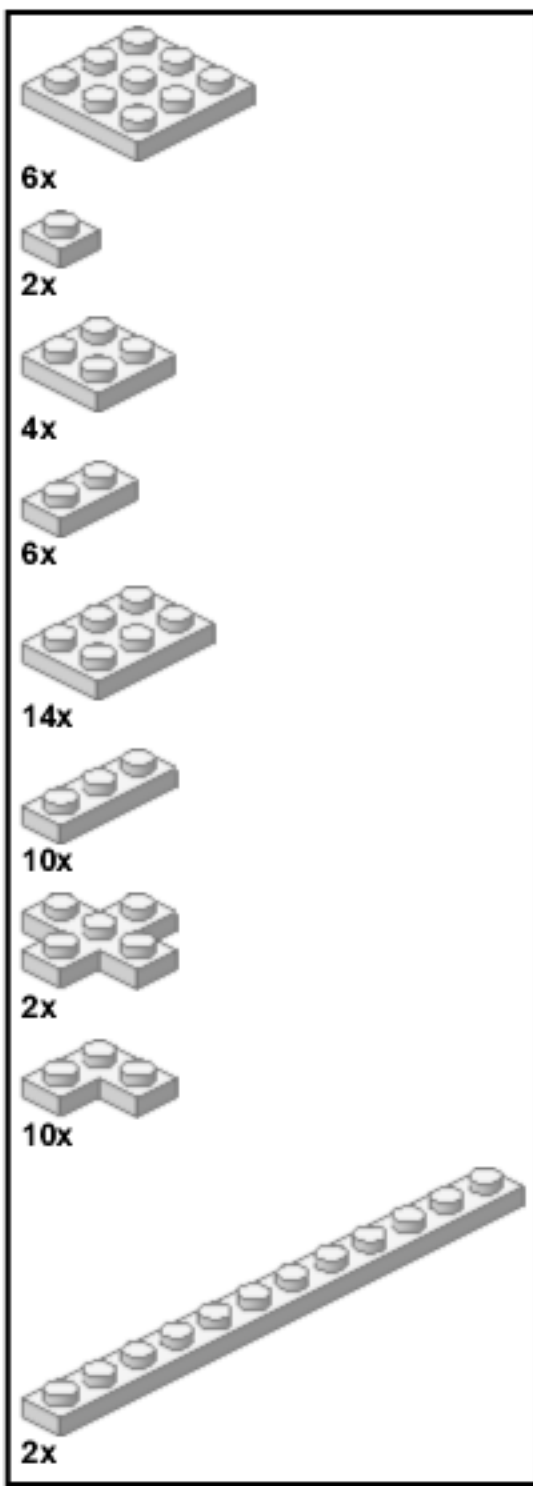
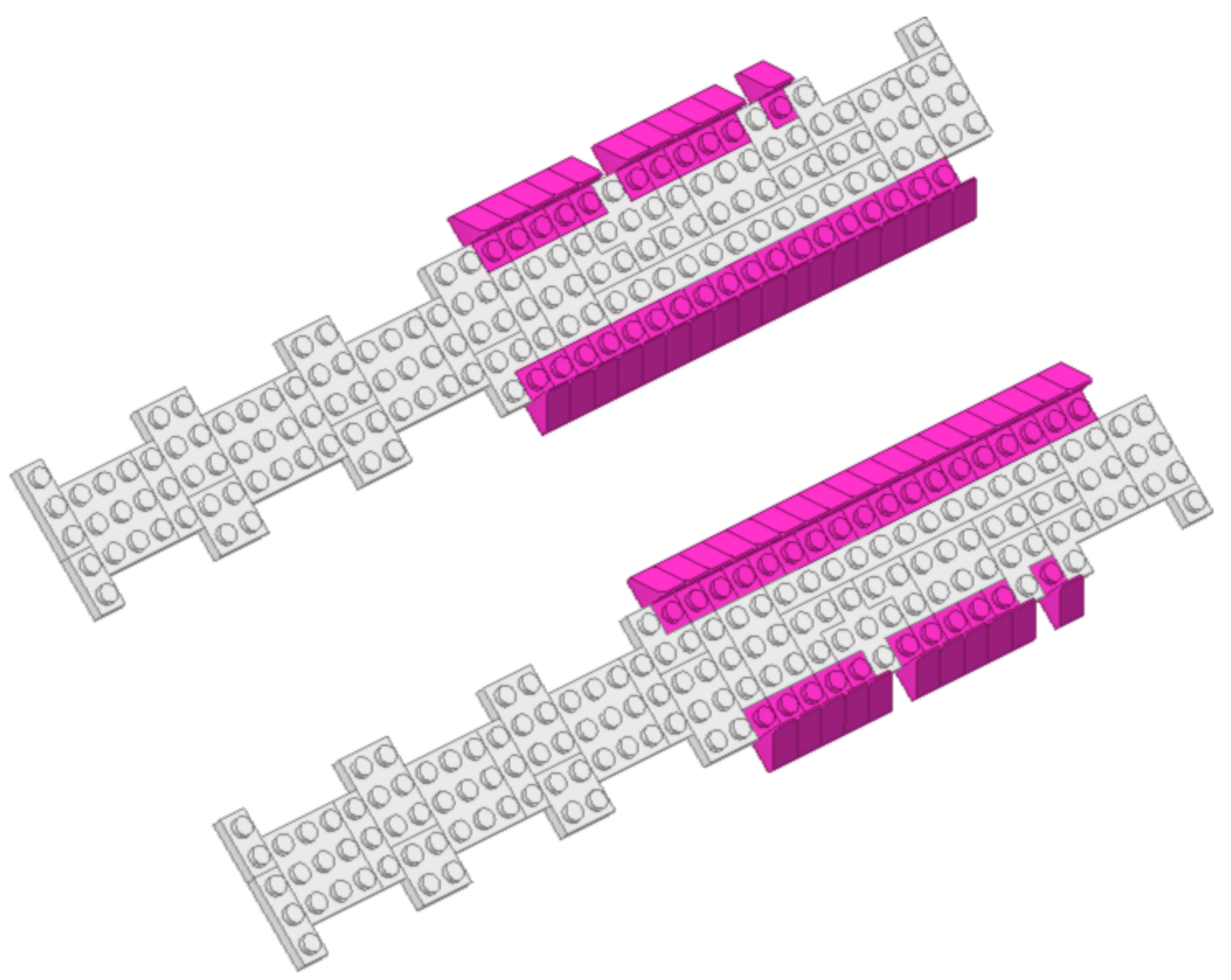

3

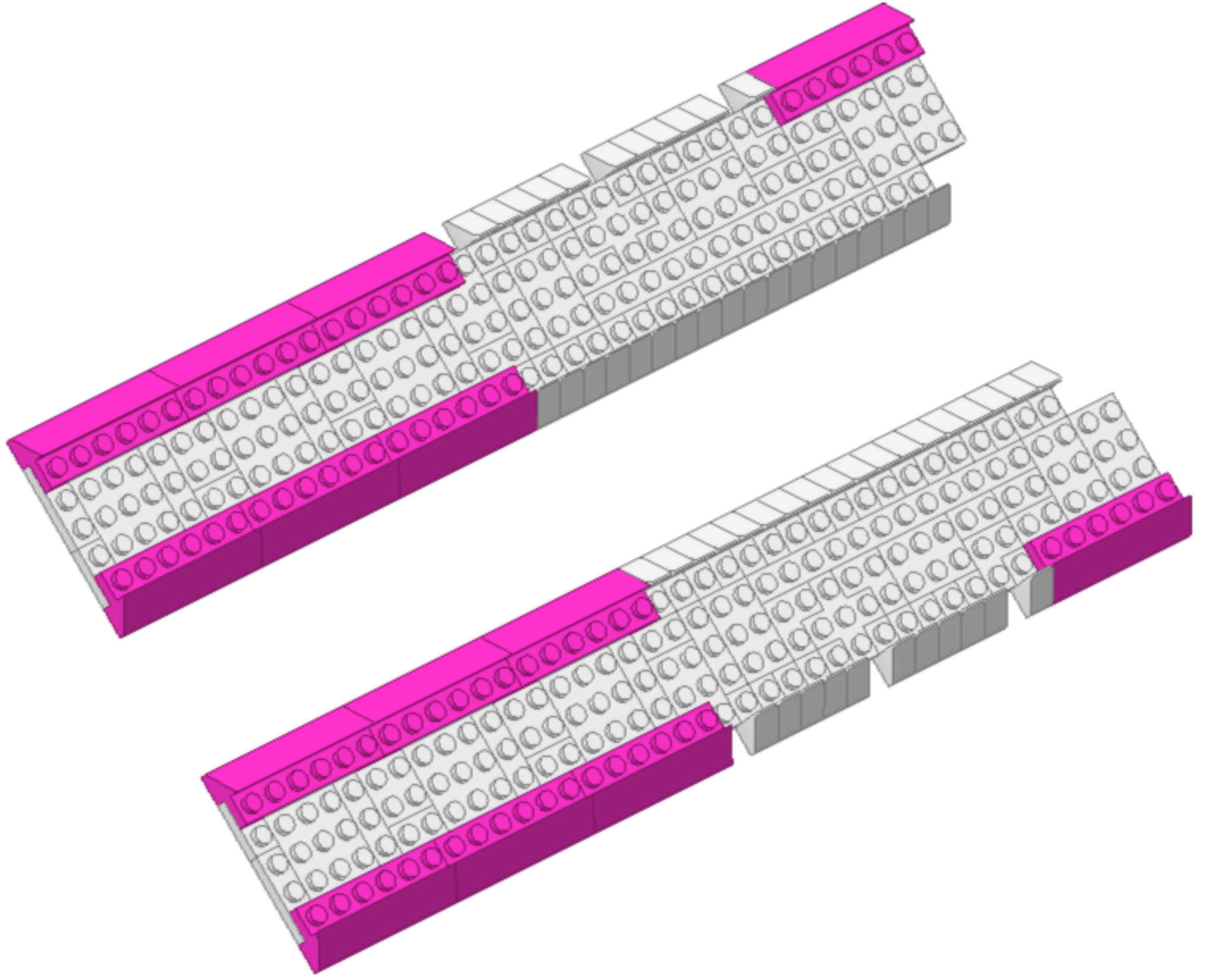
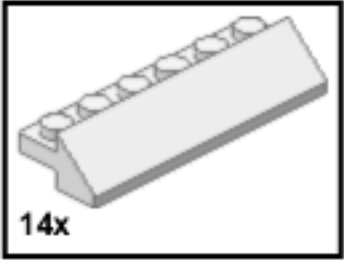

4

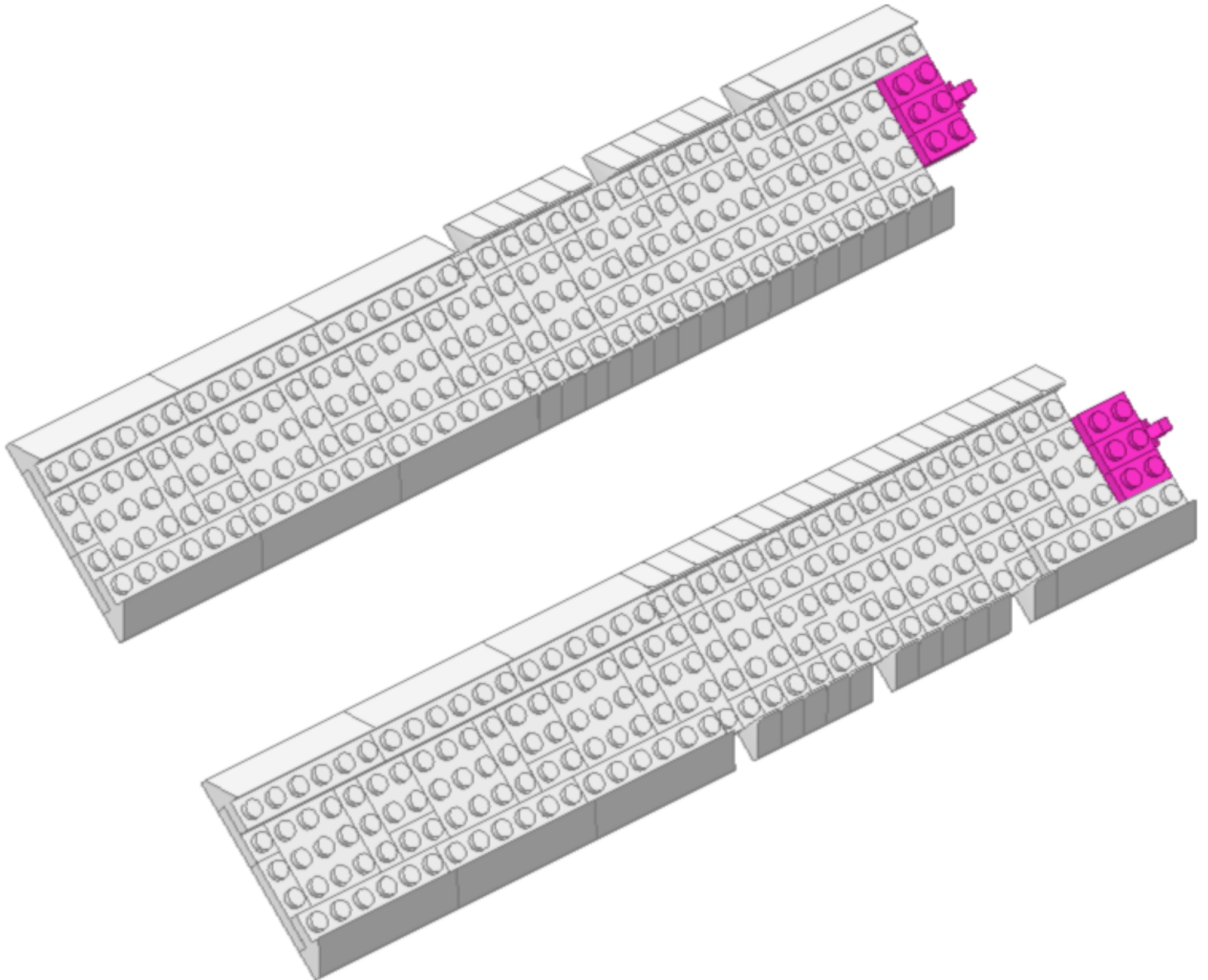
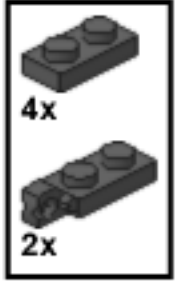

5

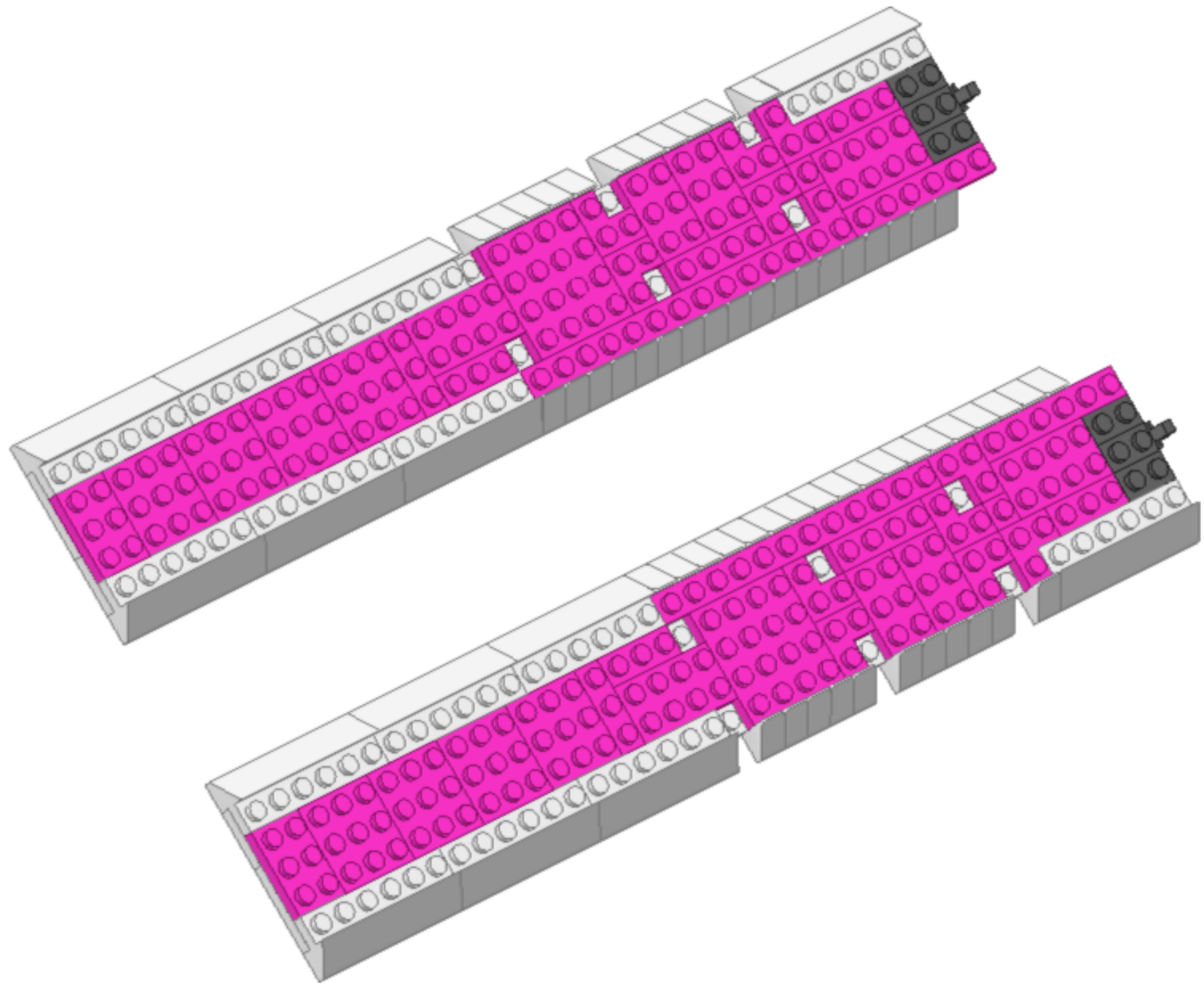
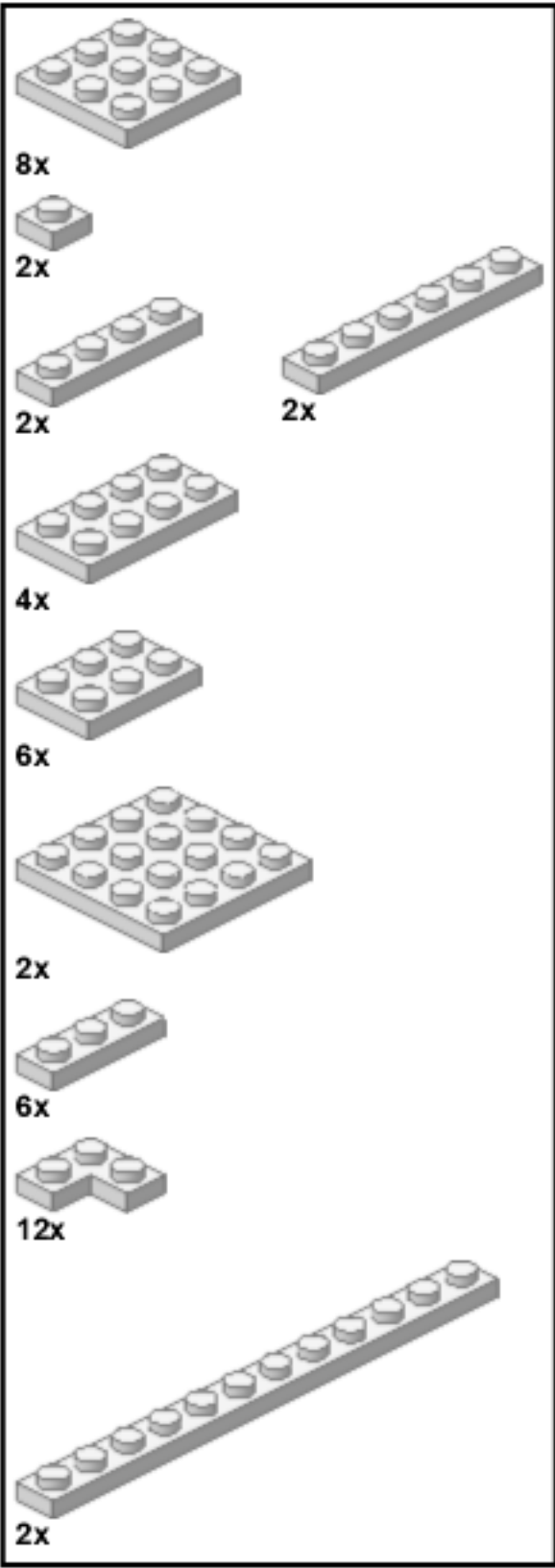

6

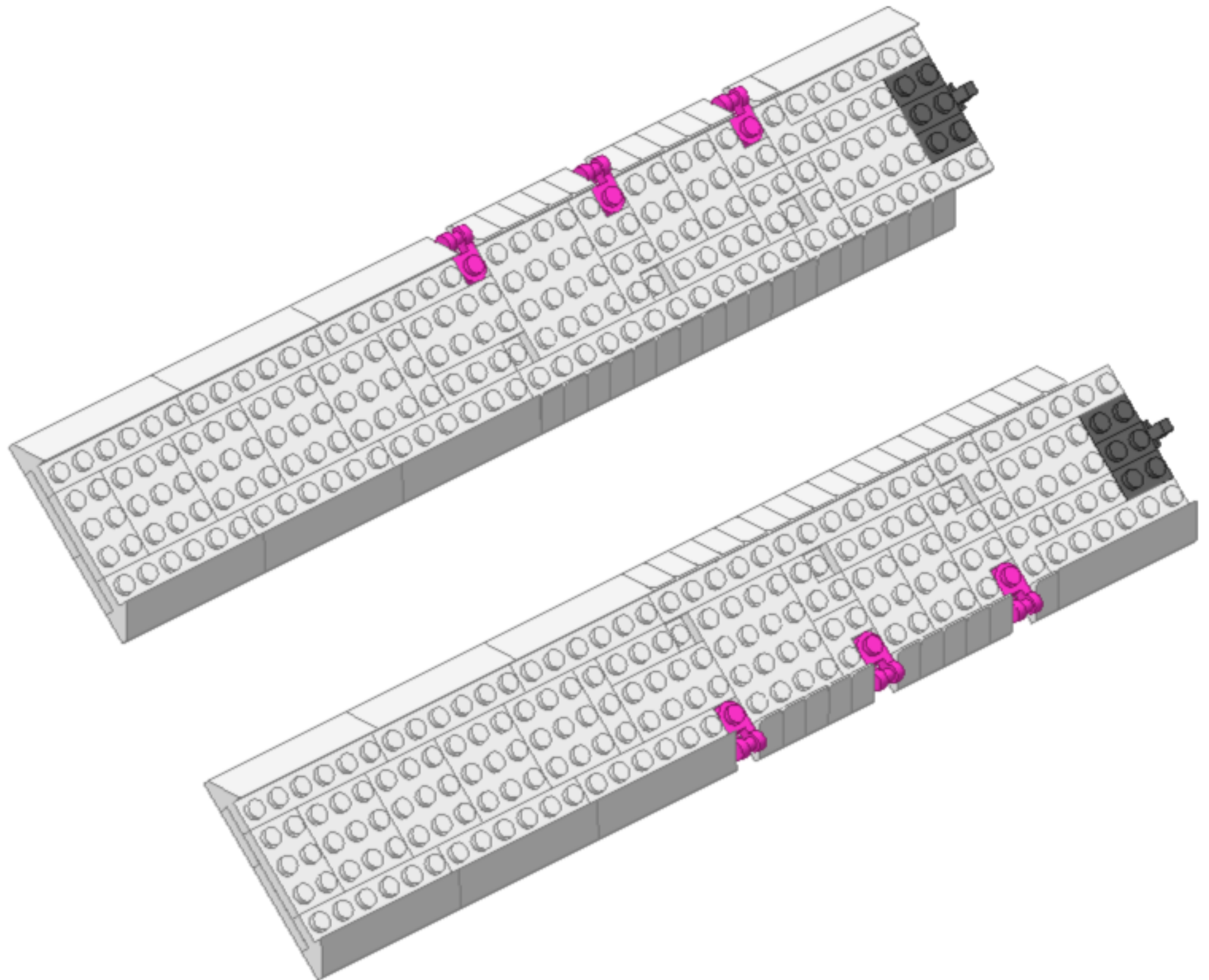

7

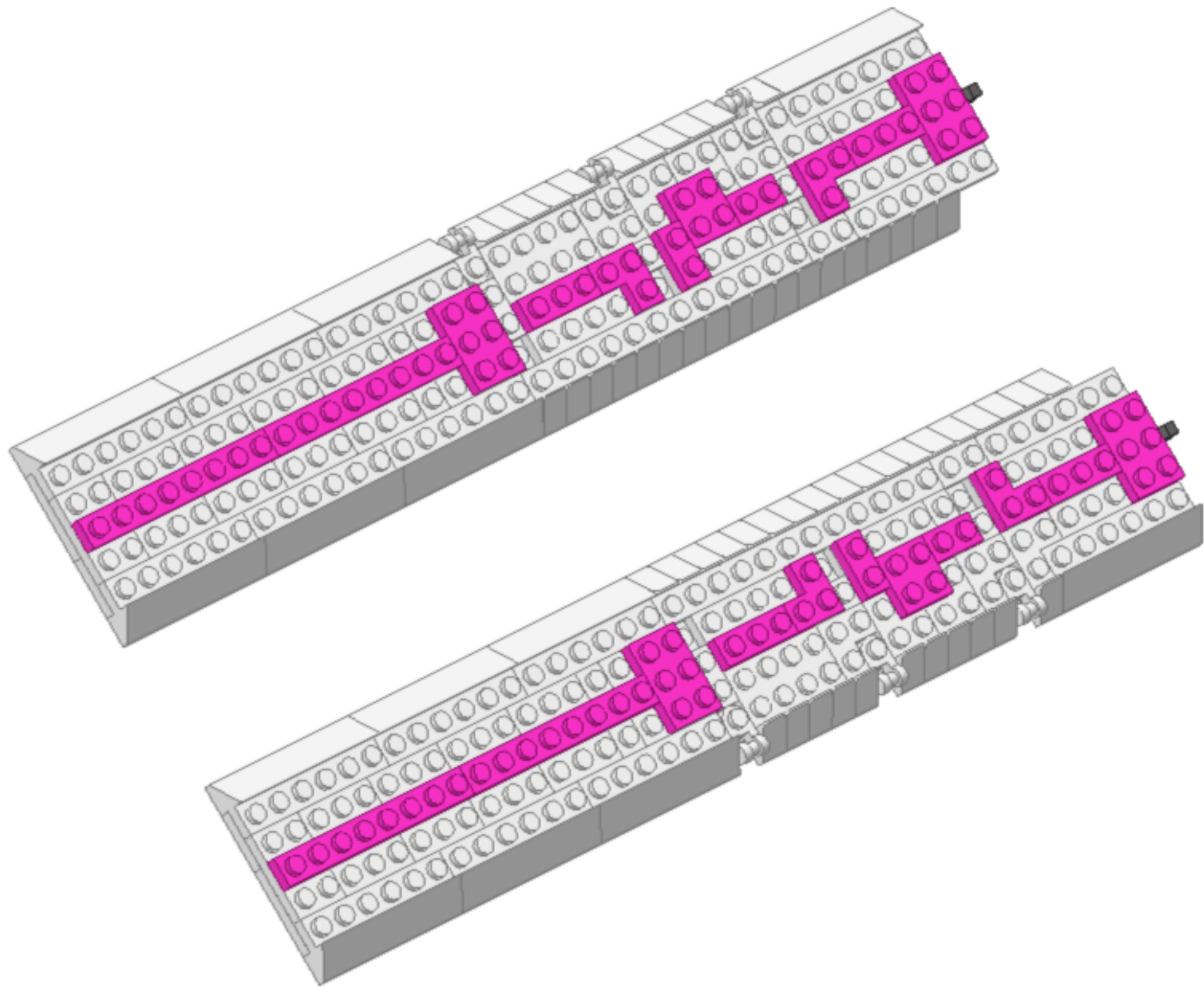
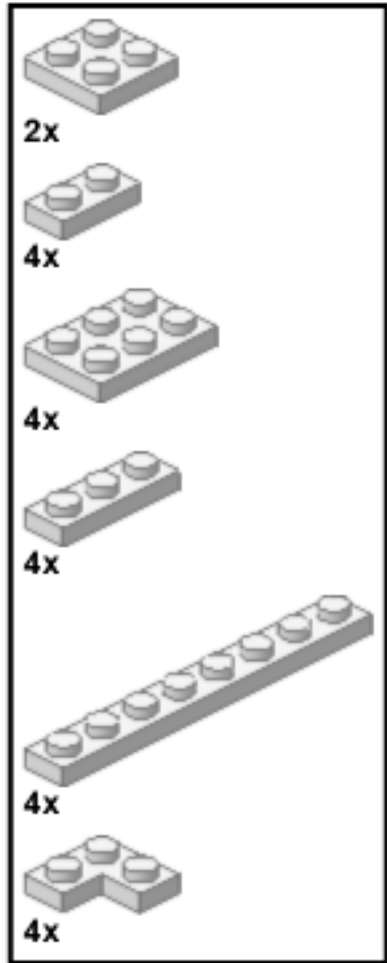

8

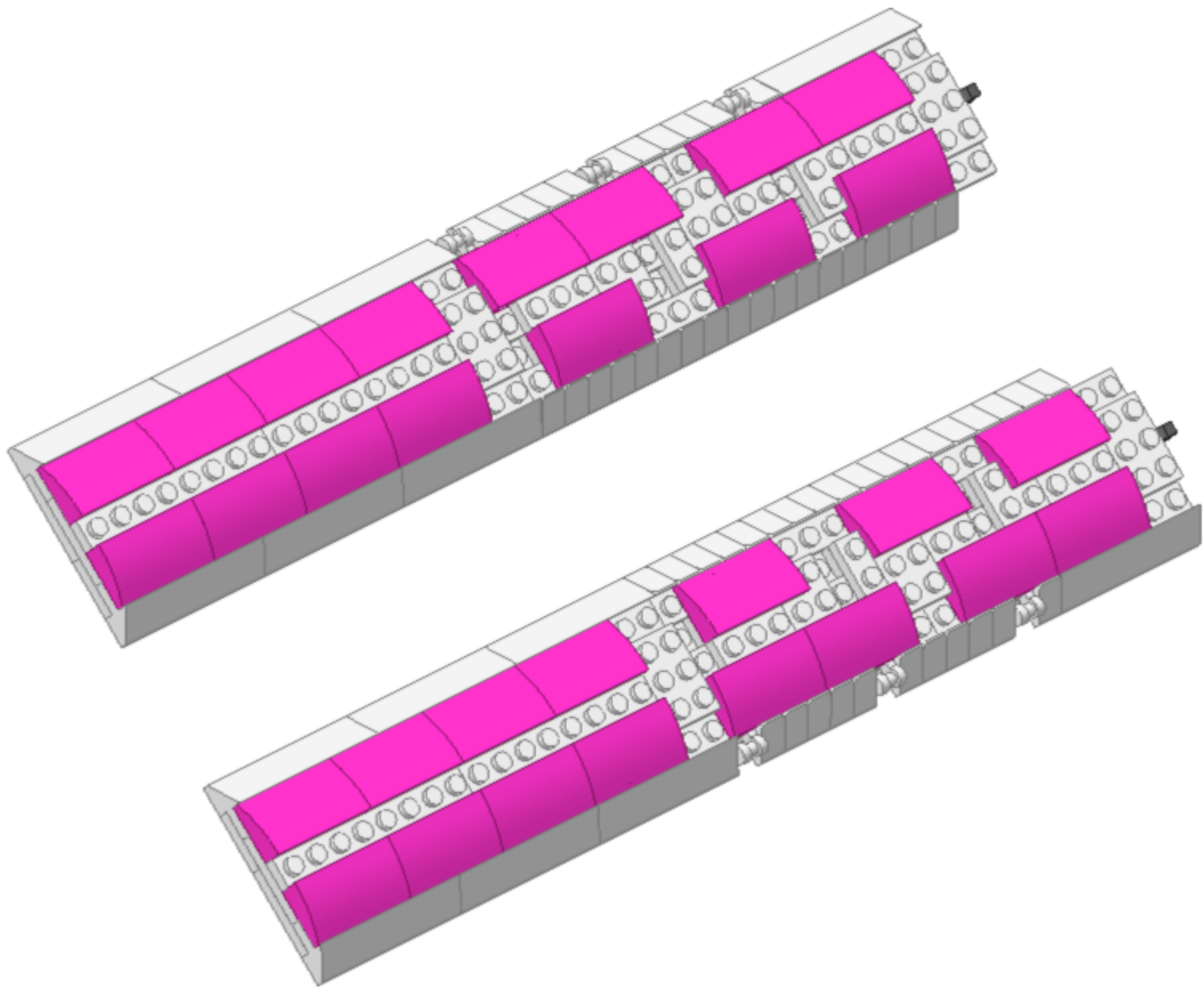
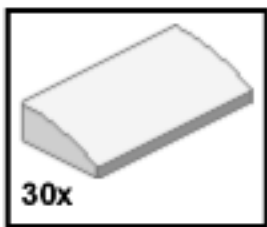

9

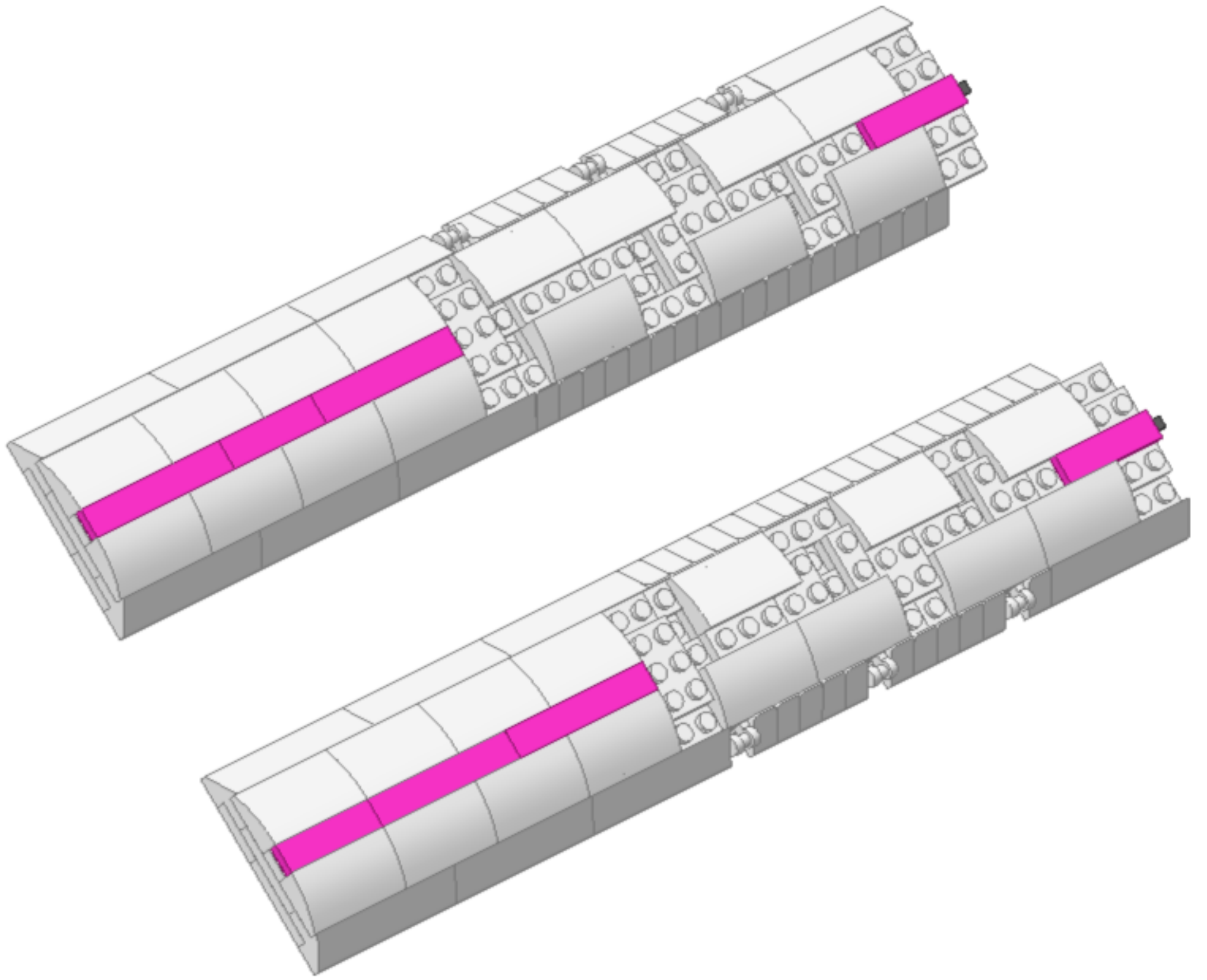
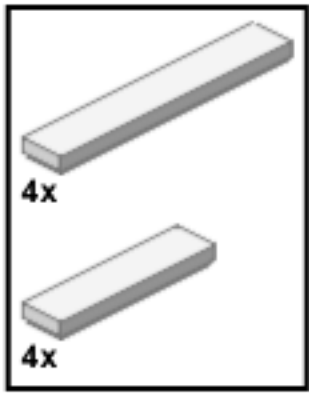

10

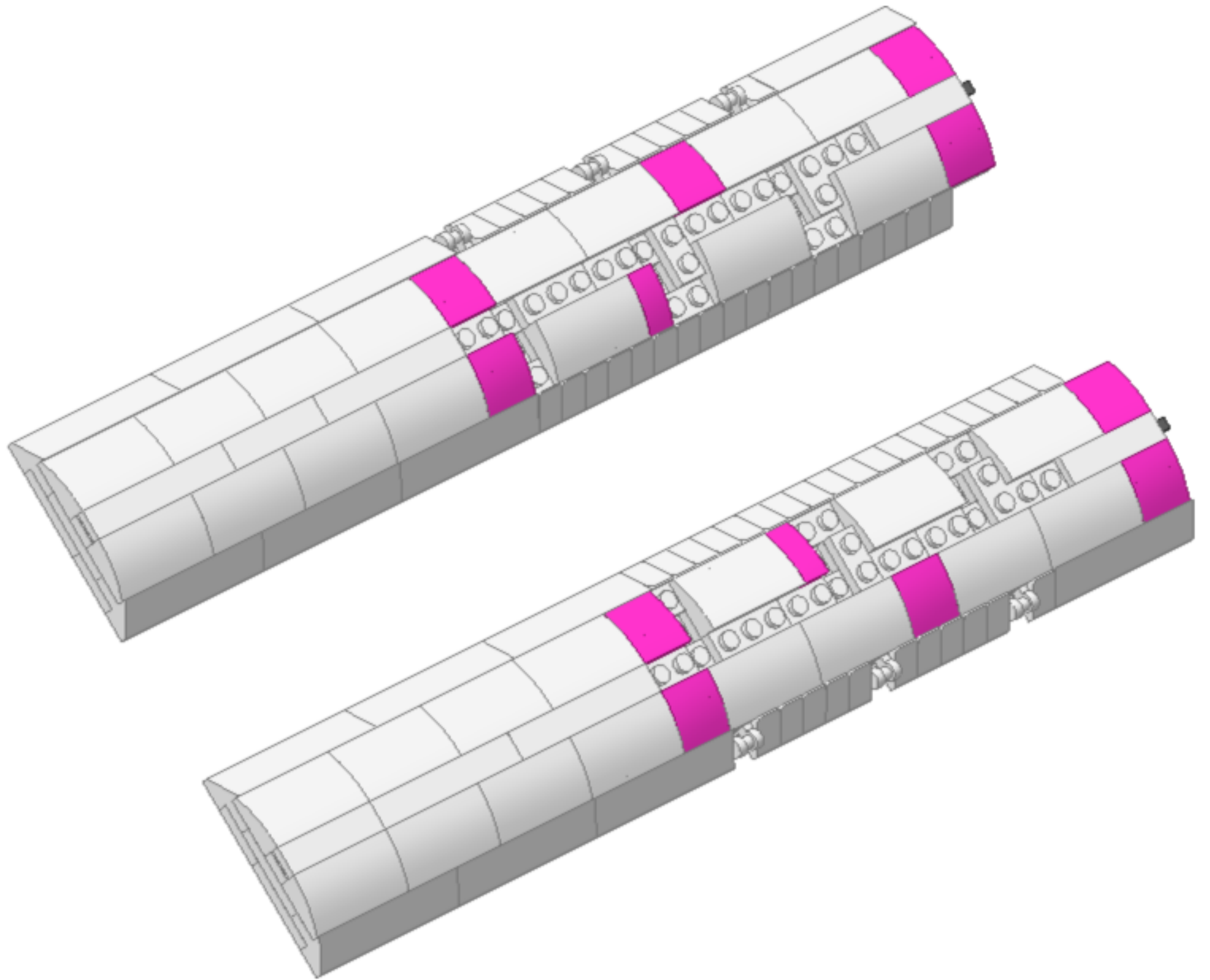
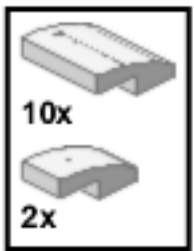

11

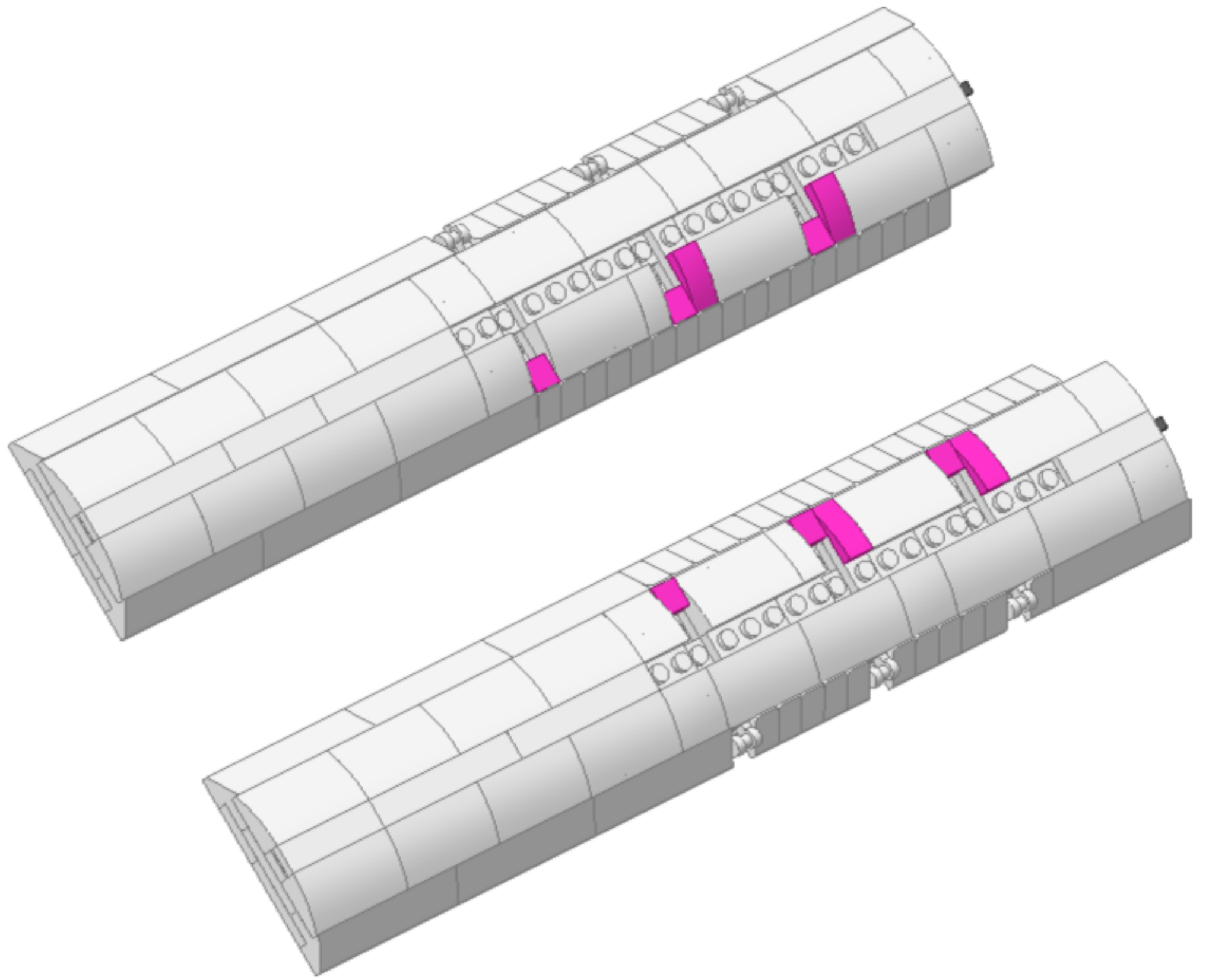
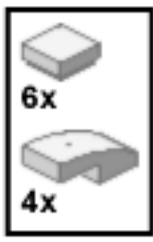

12

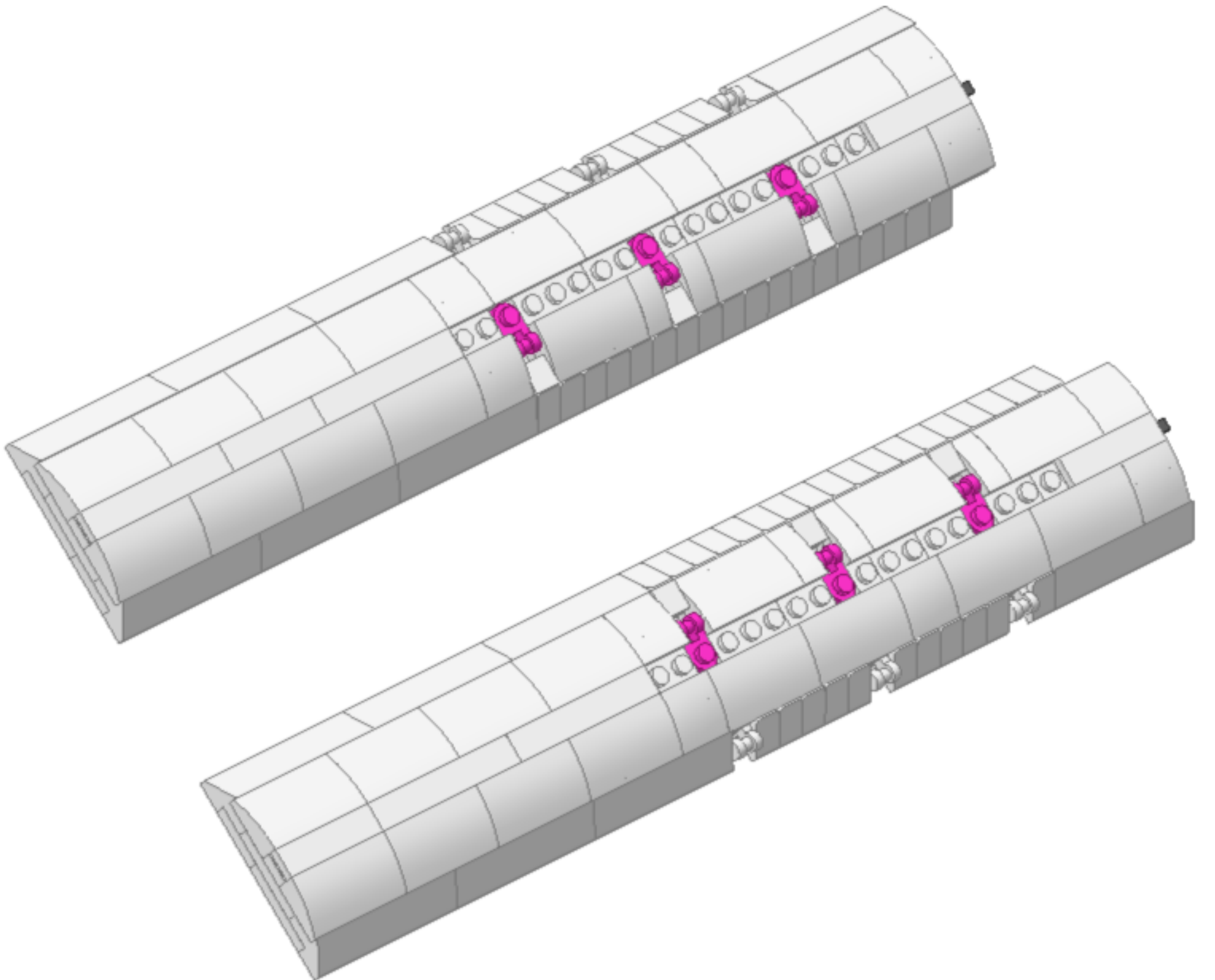

13

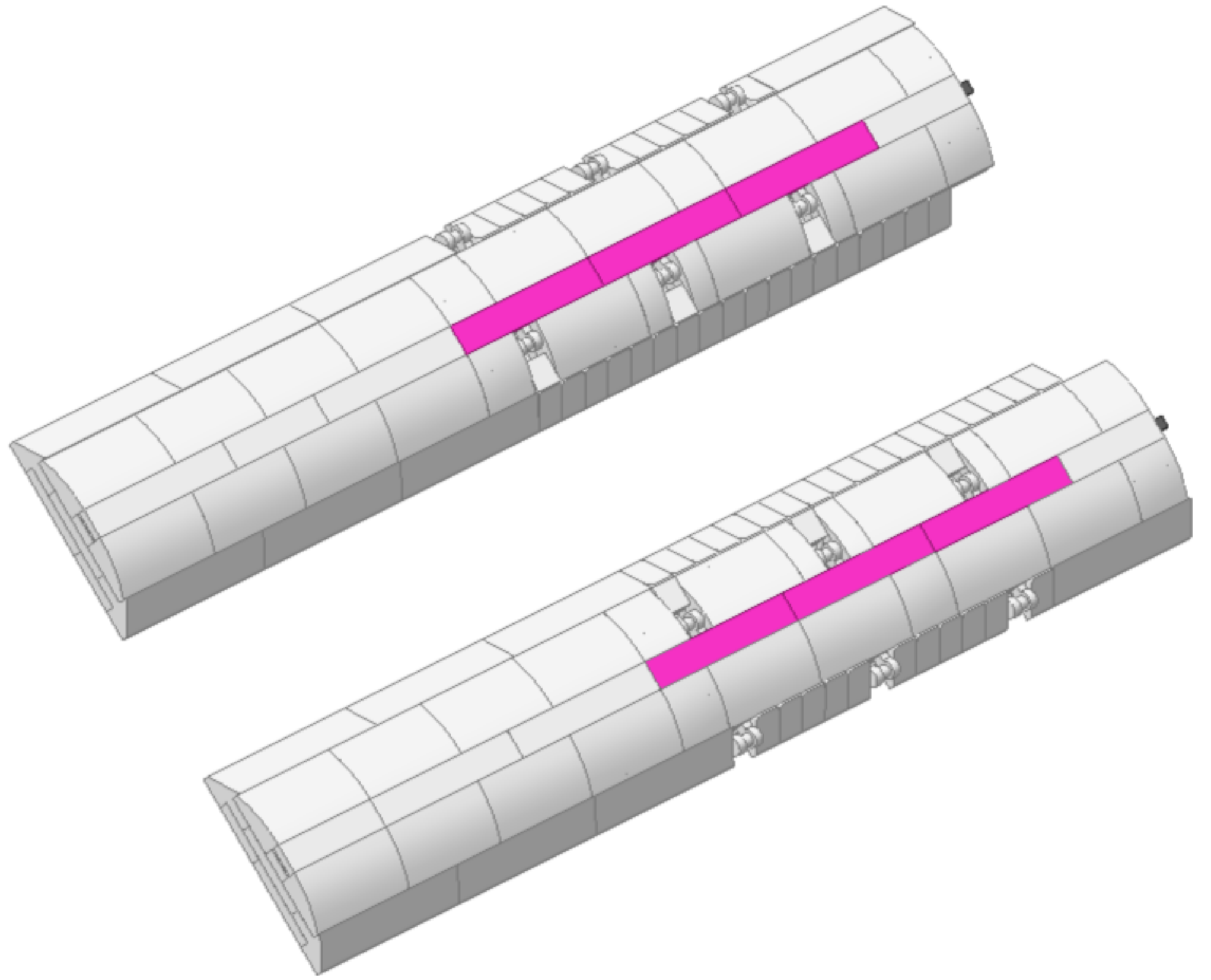
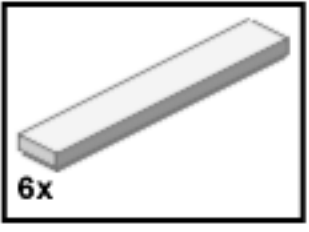



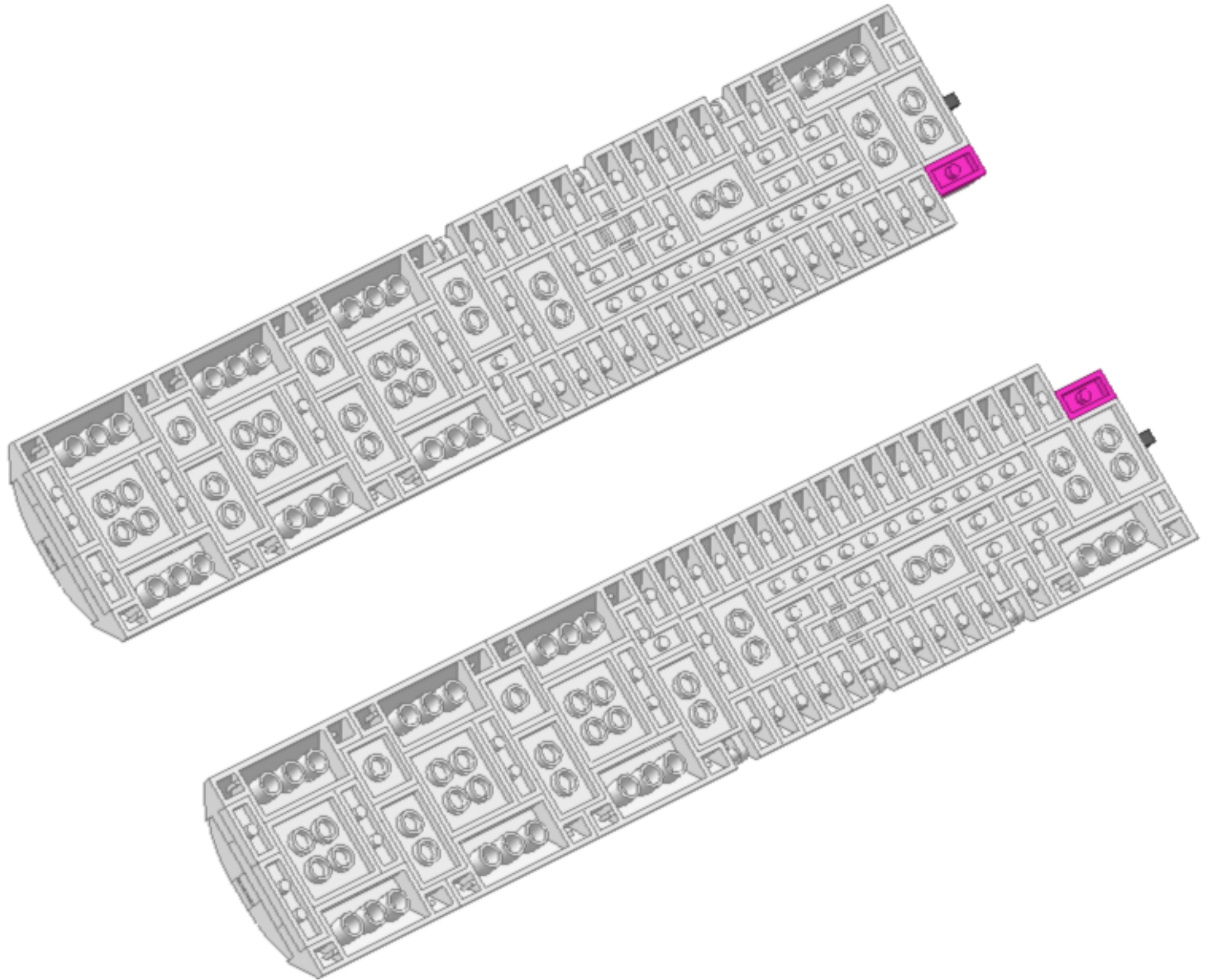
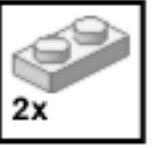

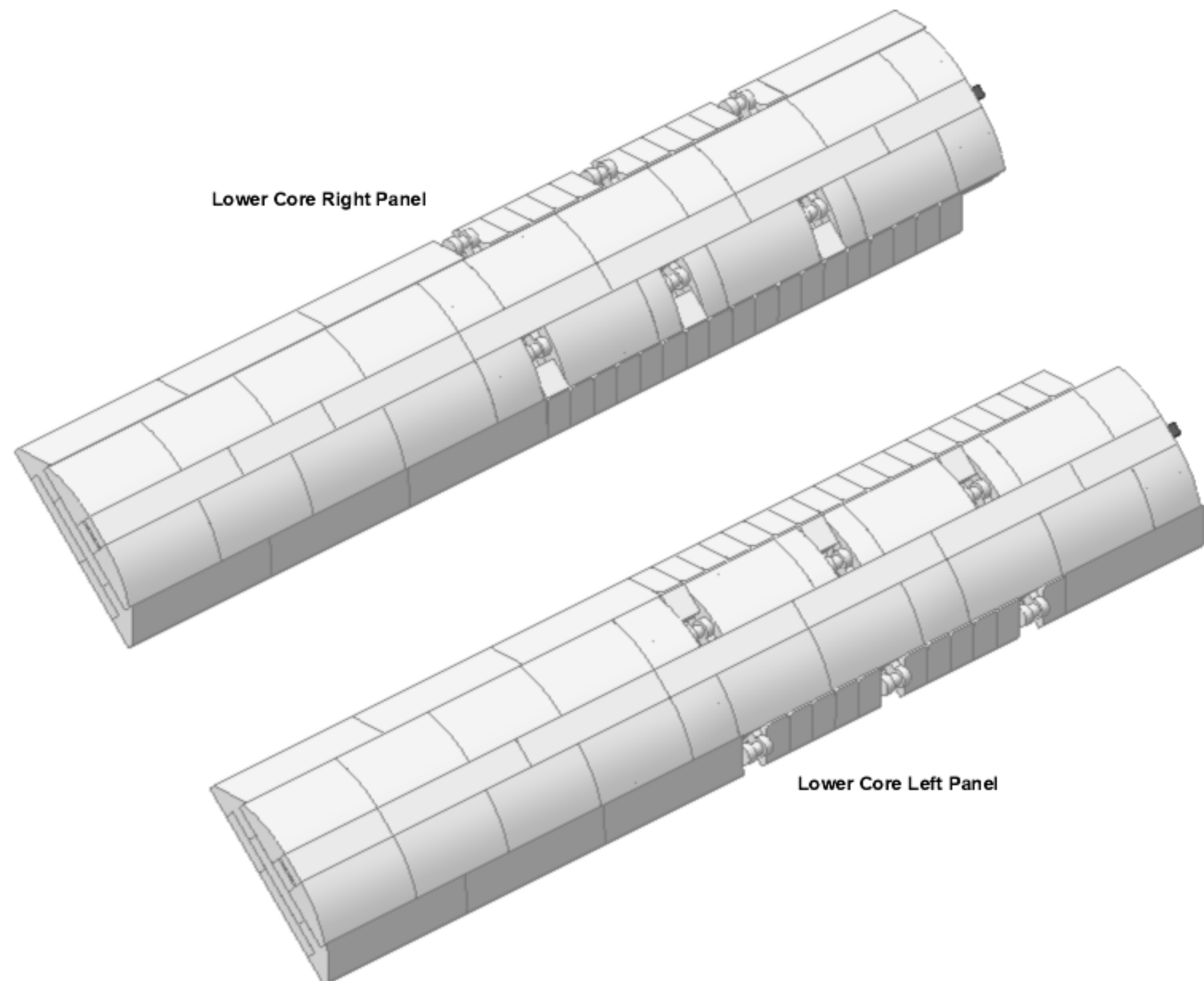















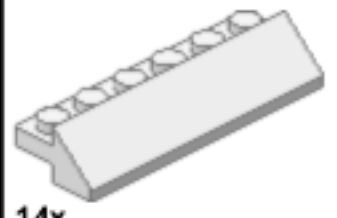



14





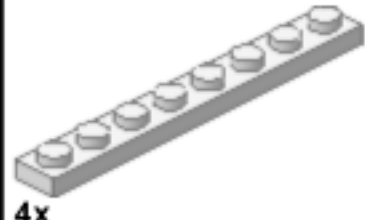

-  2x
-  2x
-  58x
-  4x
-  6x
-  6x
-  2x
-  26x
-  12x
-  10x
-  24x
-  10x
-  4x
-  14x
-  2x
-  12x
-  14x
-  4x
-  6x
-  4x
-  30x
-  20x
-  2x
-  4x
-  4x