

13

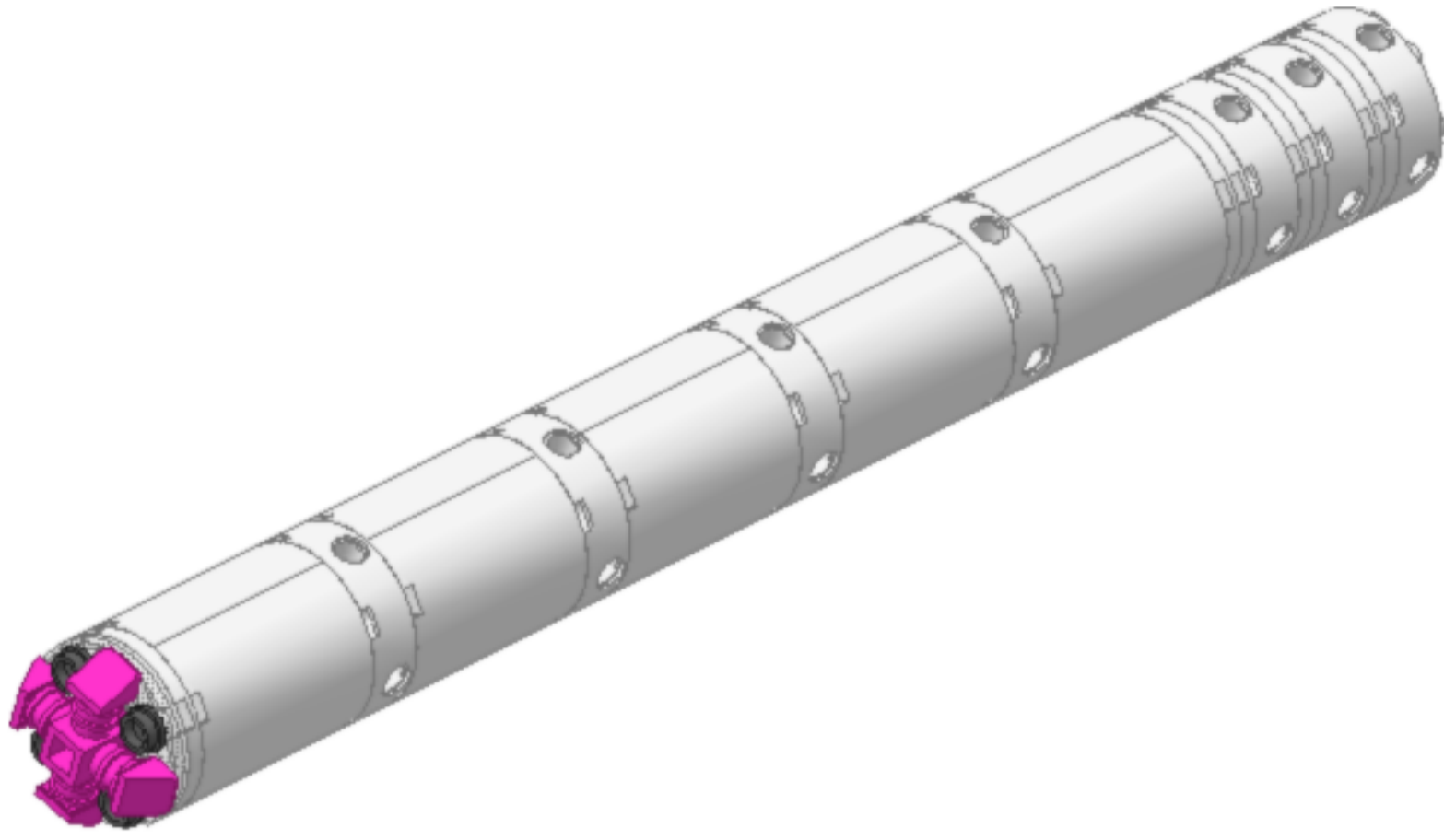

14

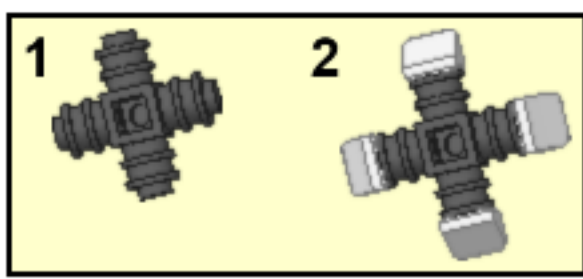

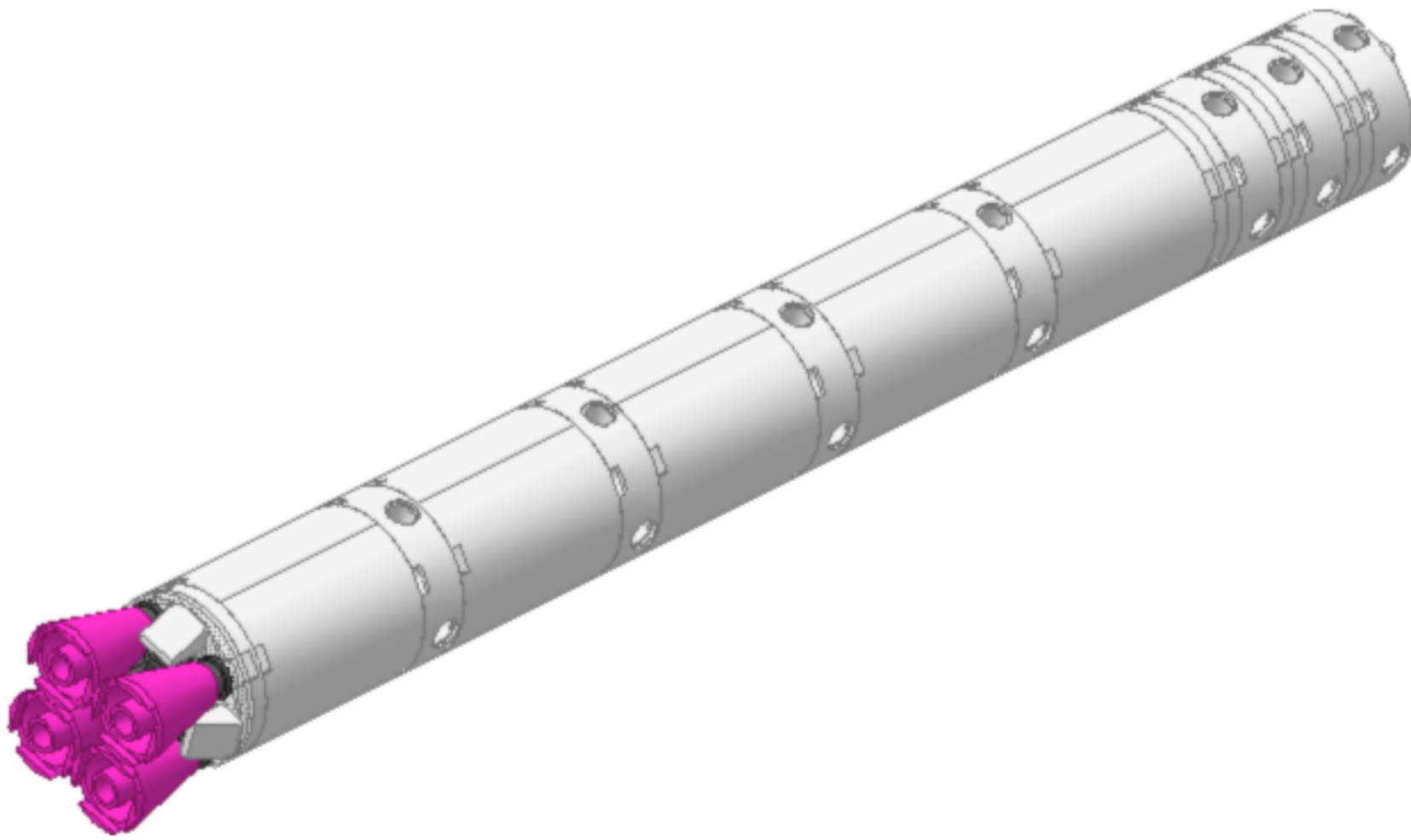
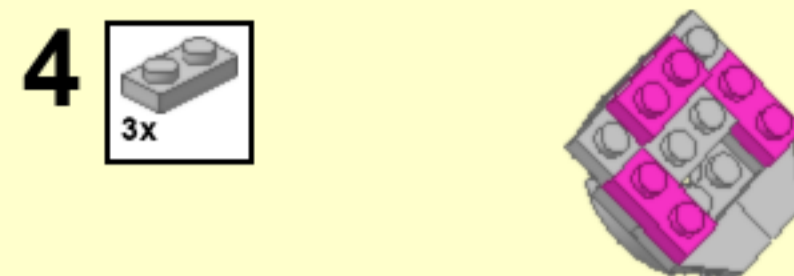
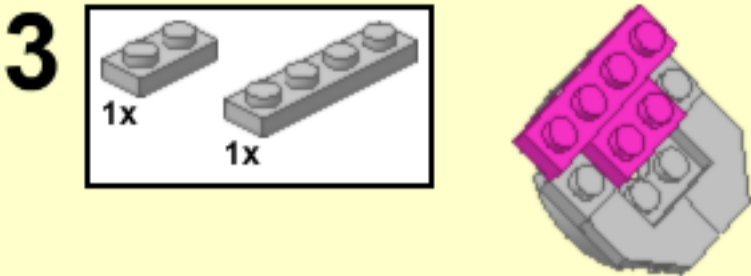
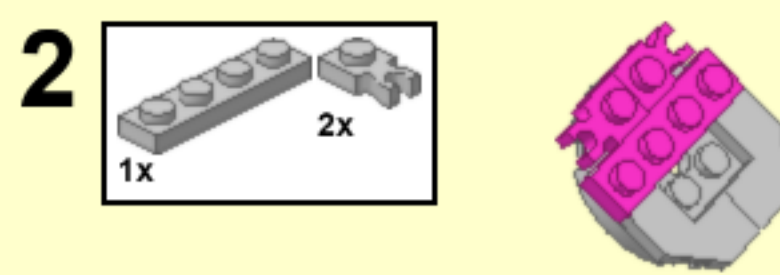
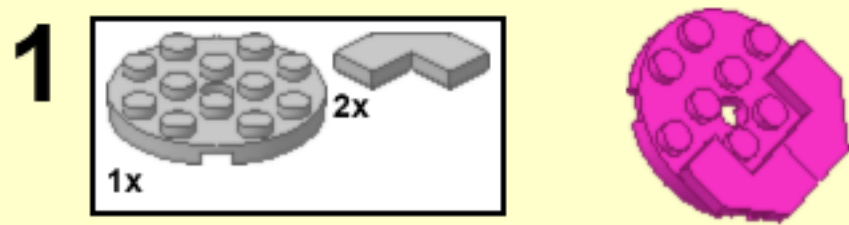

NOTE: 2x1 roof tile should be placed on studs between 1x1 tiles
There is space in real life but the brick would not place in the LDD file used to generate this PDF
Consult the assembled Stud.IO files for details

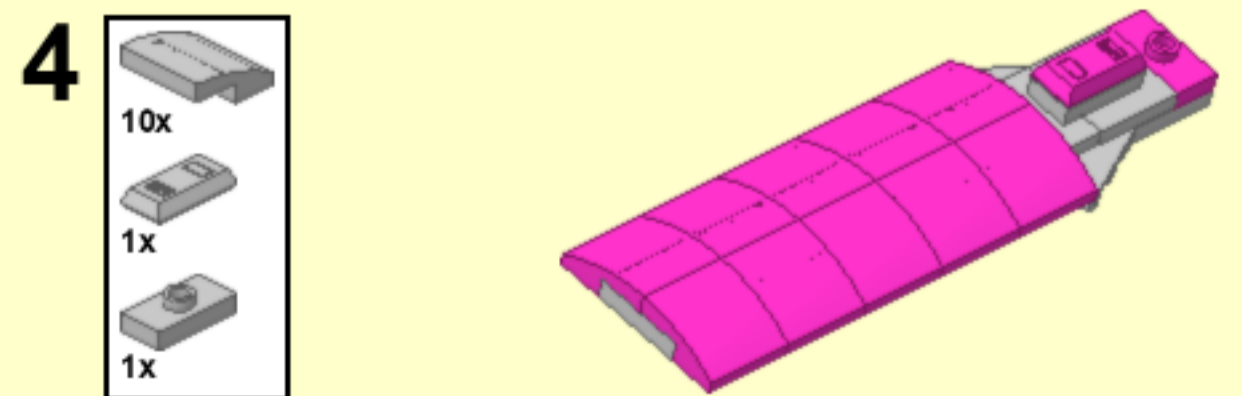
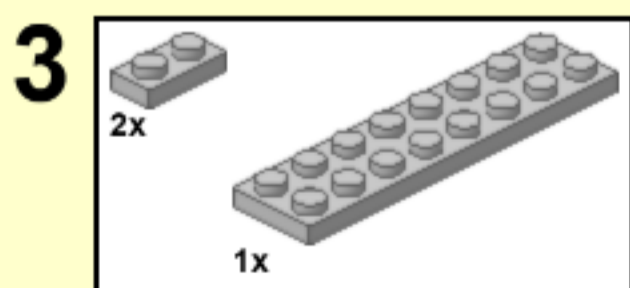
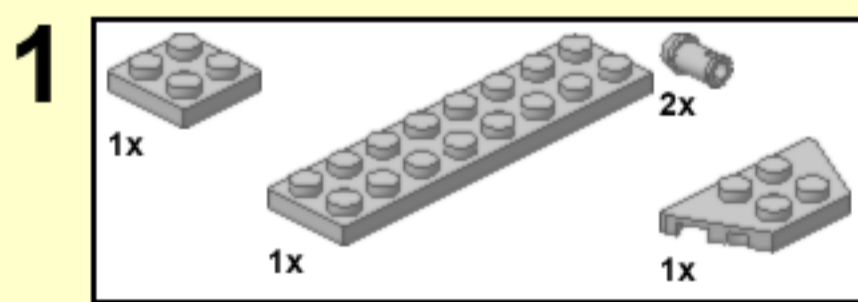
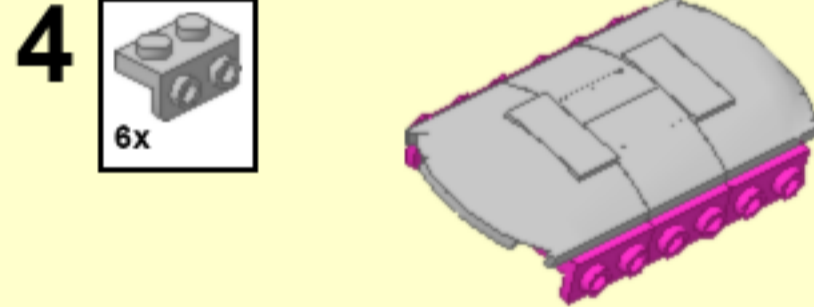
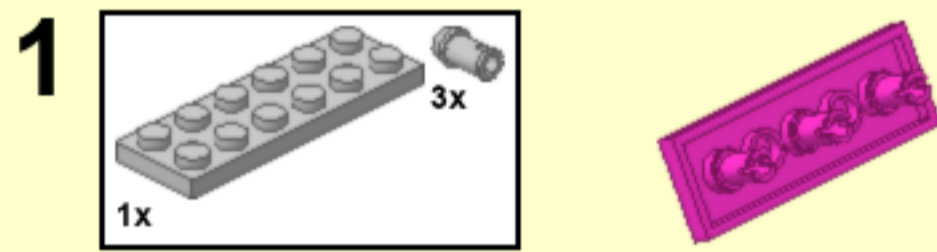
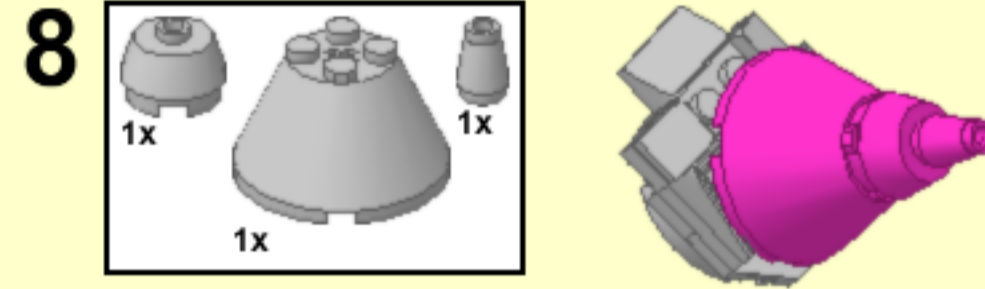

15

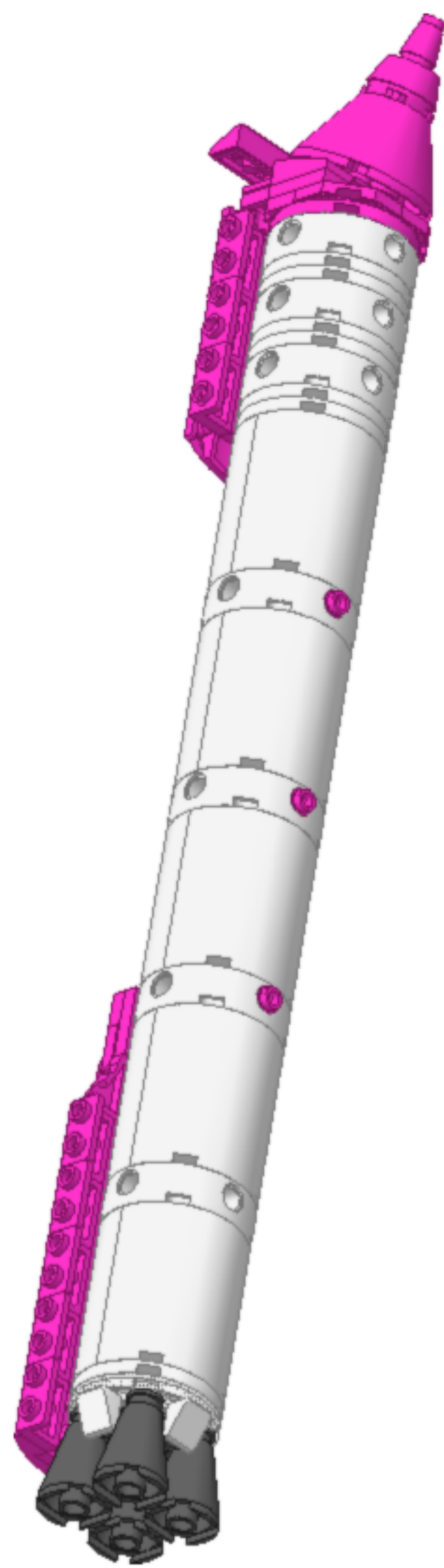
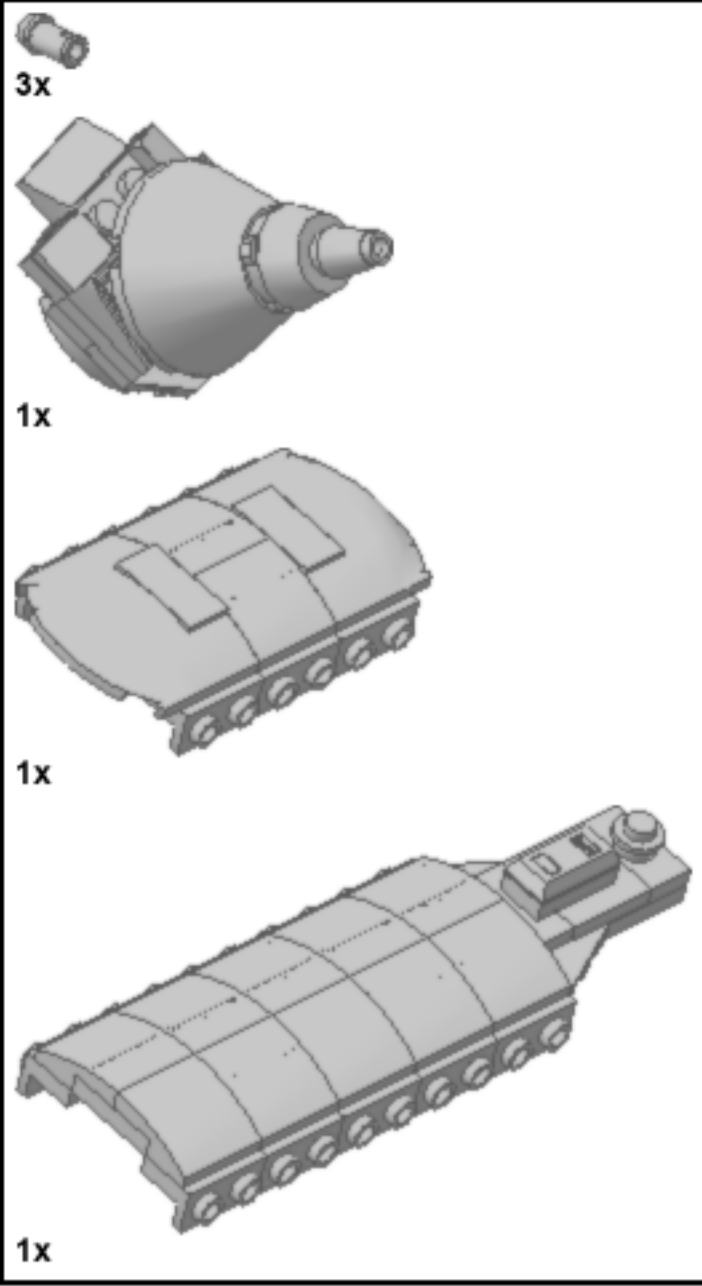

16

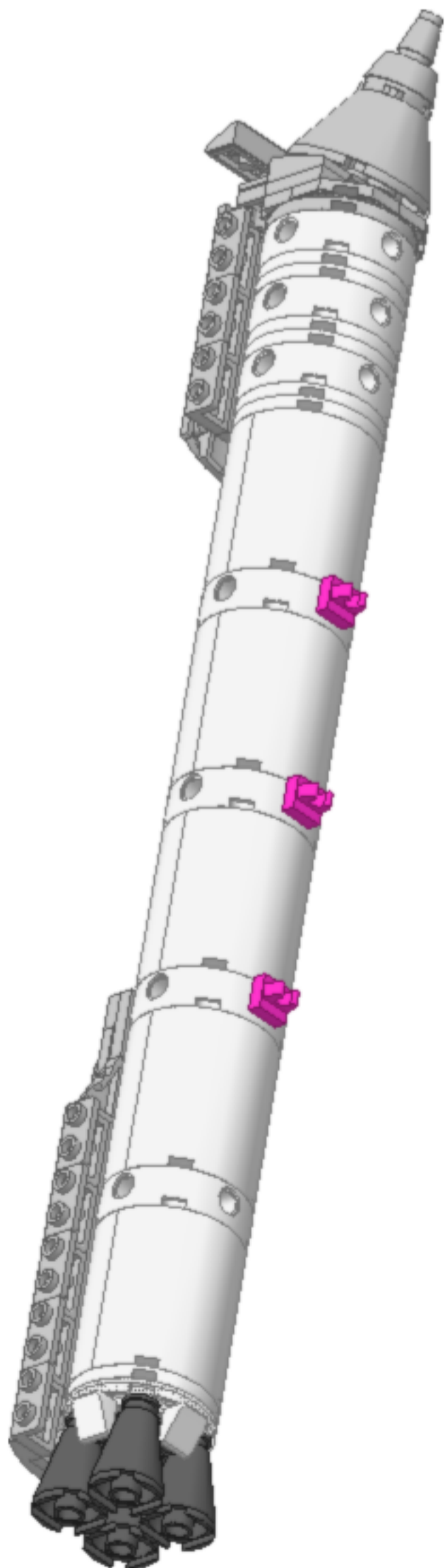

17

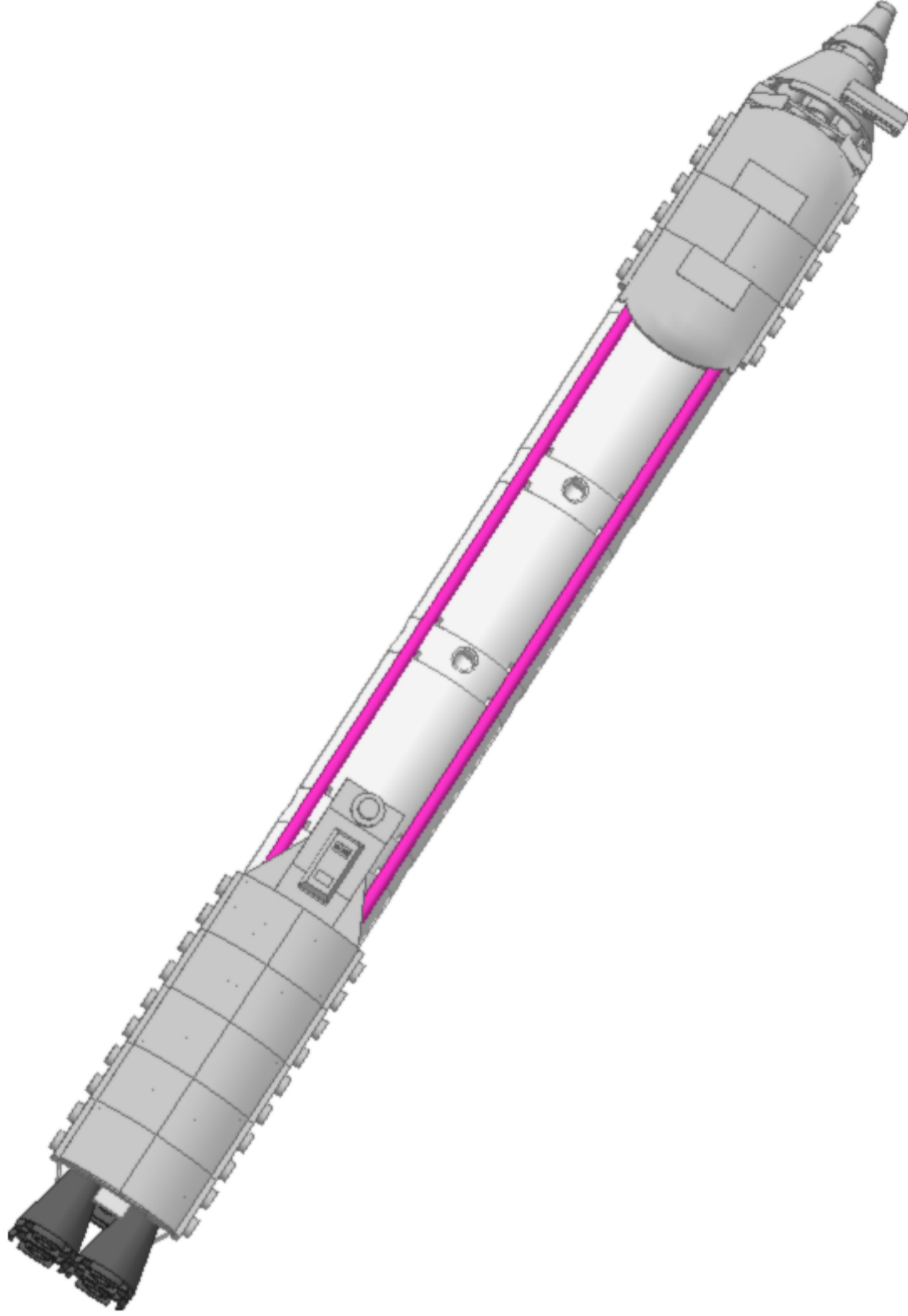
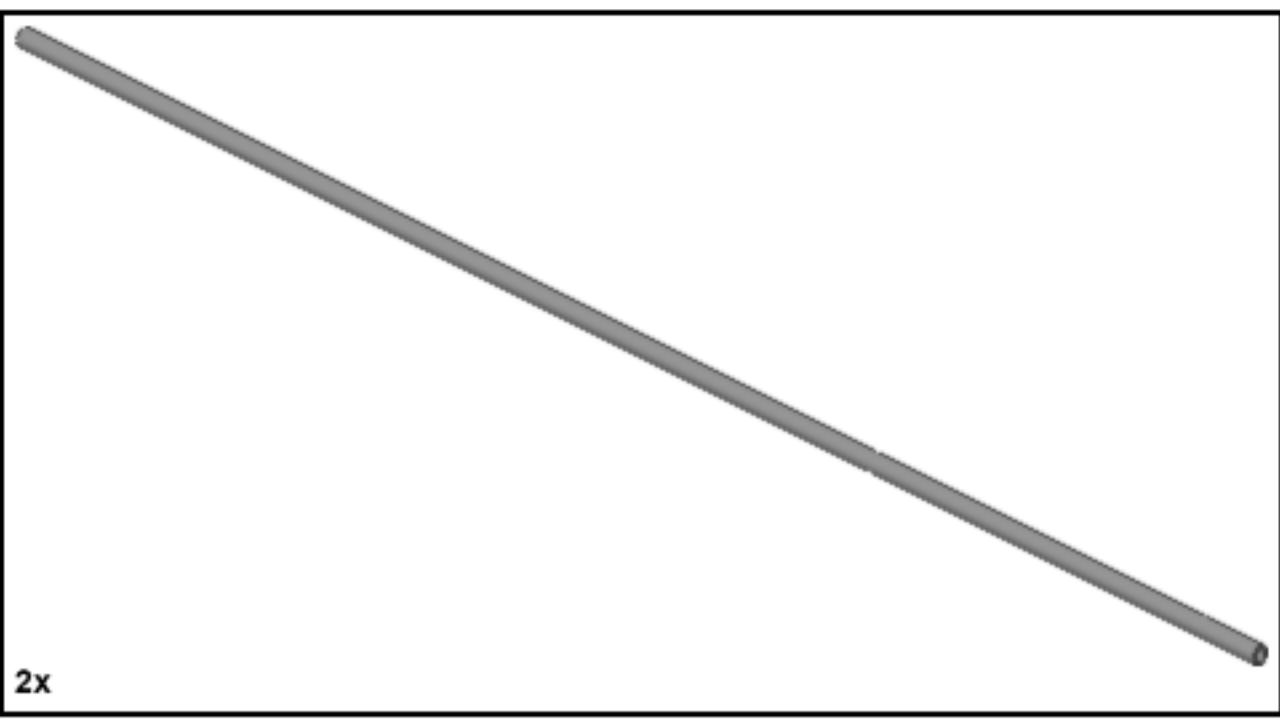



5x

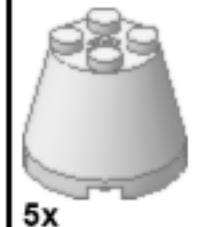

5x



7x



4x

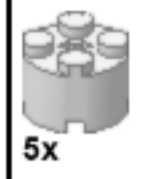

5x



7x



10x

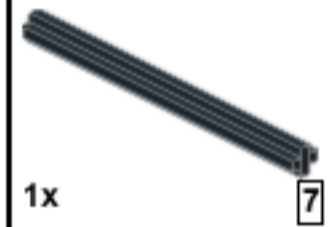

7

1x



12

2x

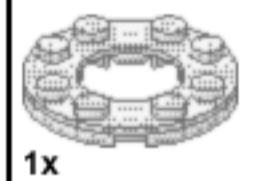

NB: Trans Clear

1x

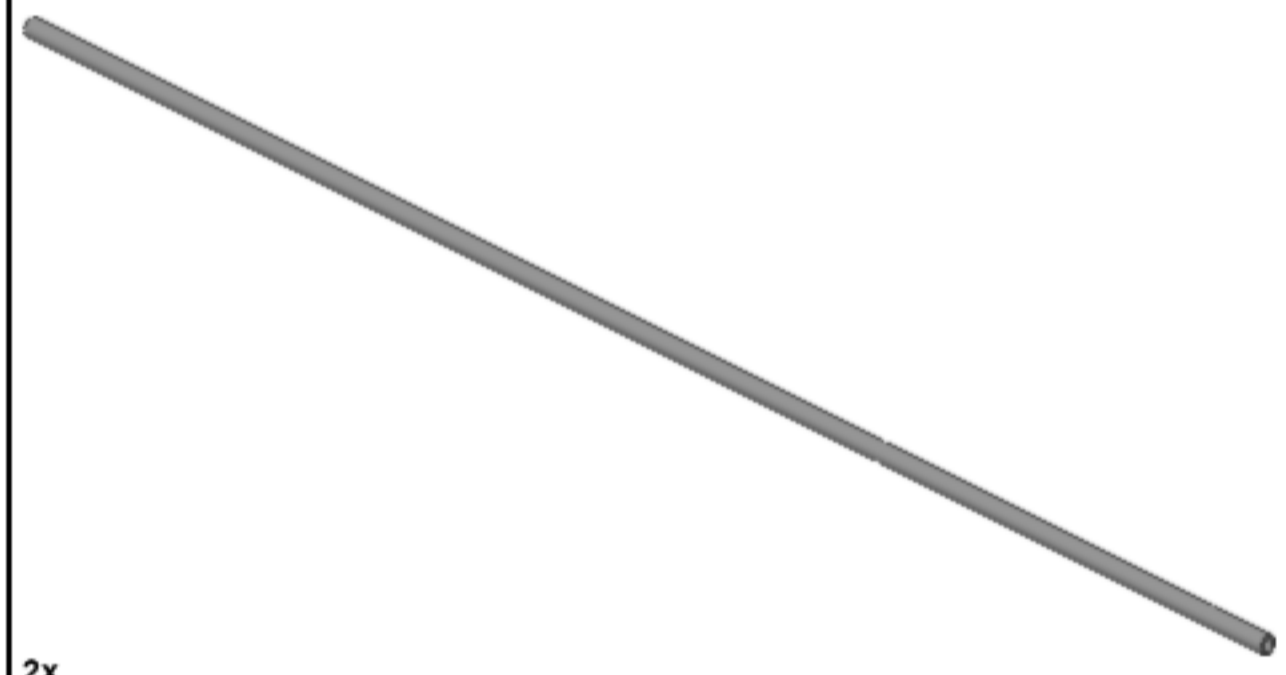

2x



3x

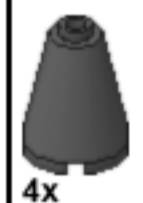

4x



13x



1x



2x

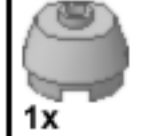

1x



2x



16x

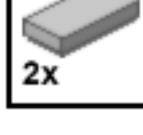

2x

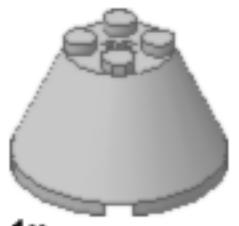

1x



1x



1x



1x



2x

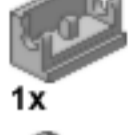

1x



2x

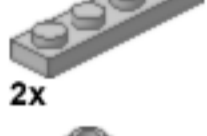

2x



1x



8x



1x



1x

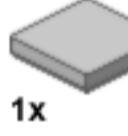

6x

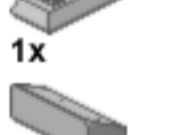

1x



1x



1x

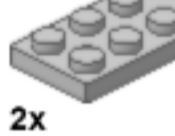

12x



2x

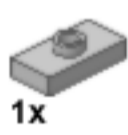

2x



2x



2x



1x