

# SATURN V LAUNCH PAD

## VOLUME 4: LUT L320 TO L380

DESIGNED BY  
NATHAN READIOFF

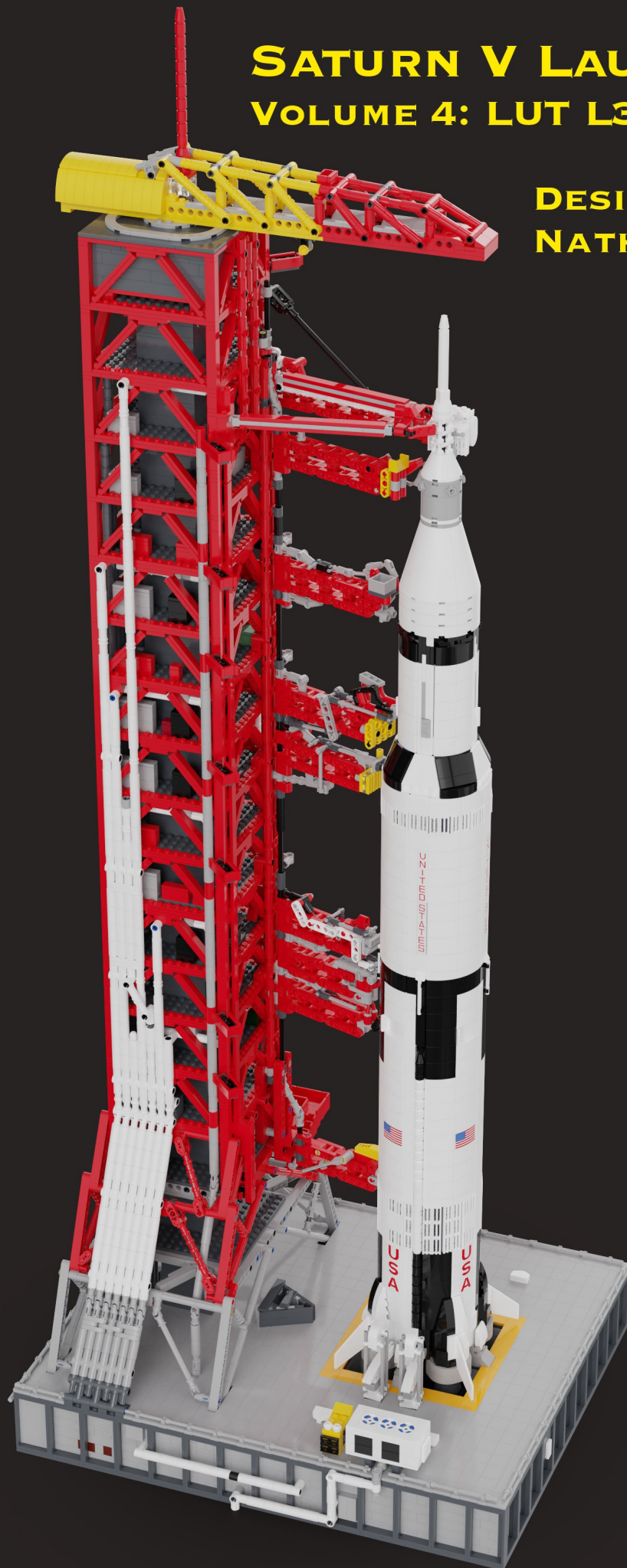

1

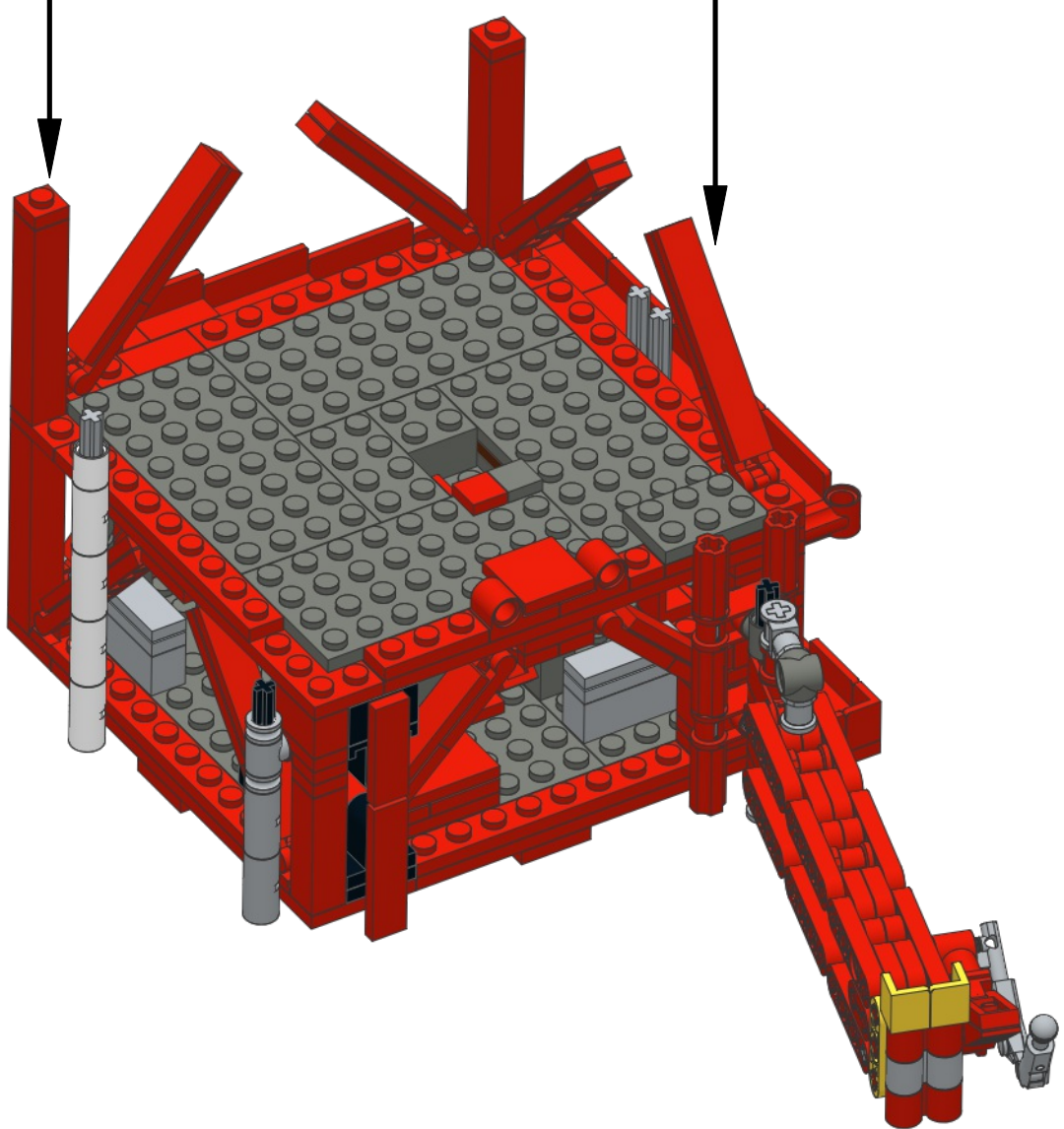
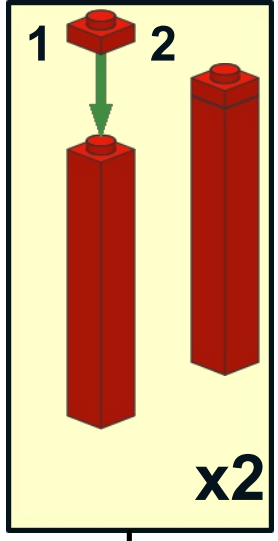
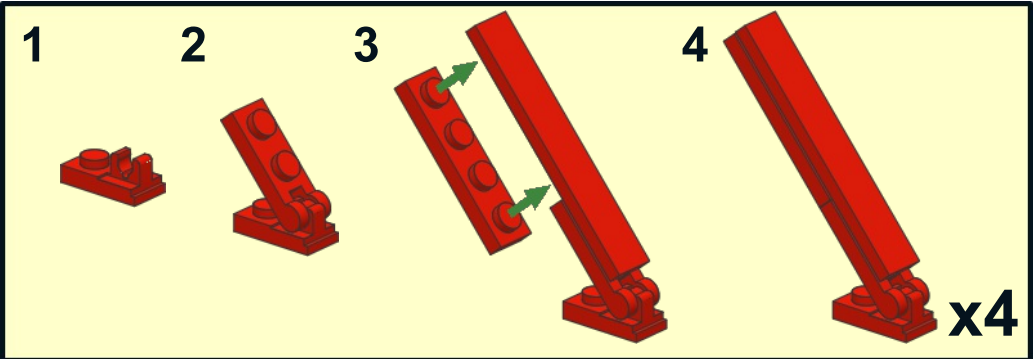
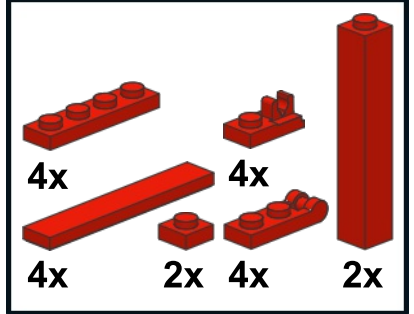



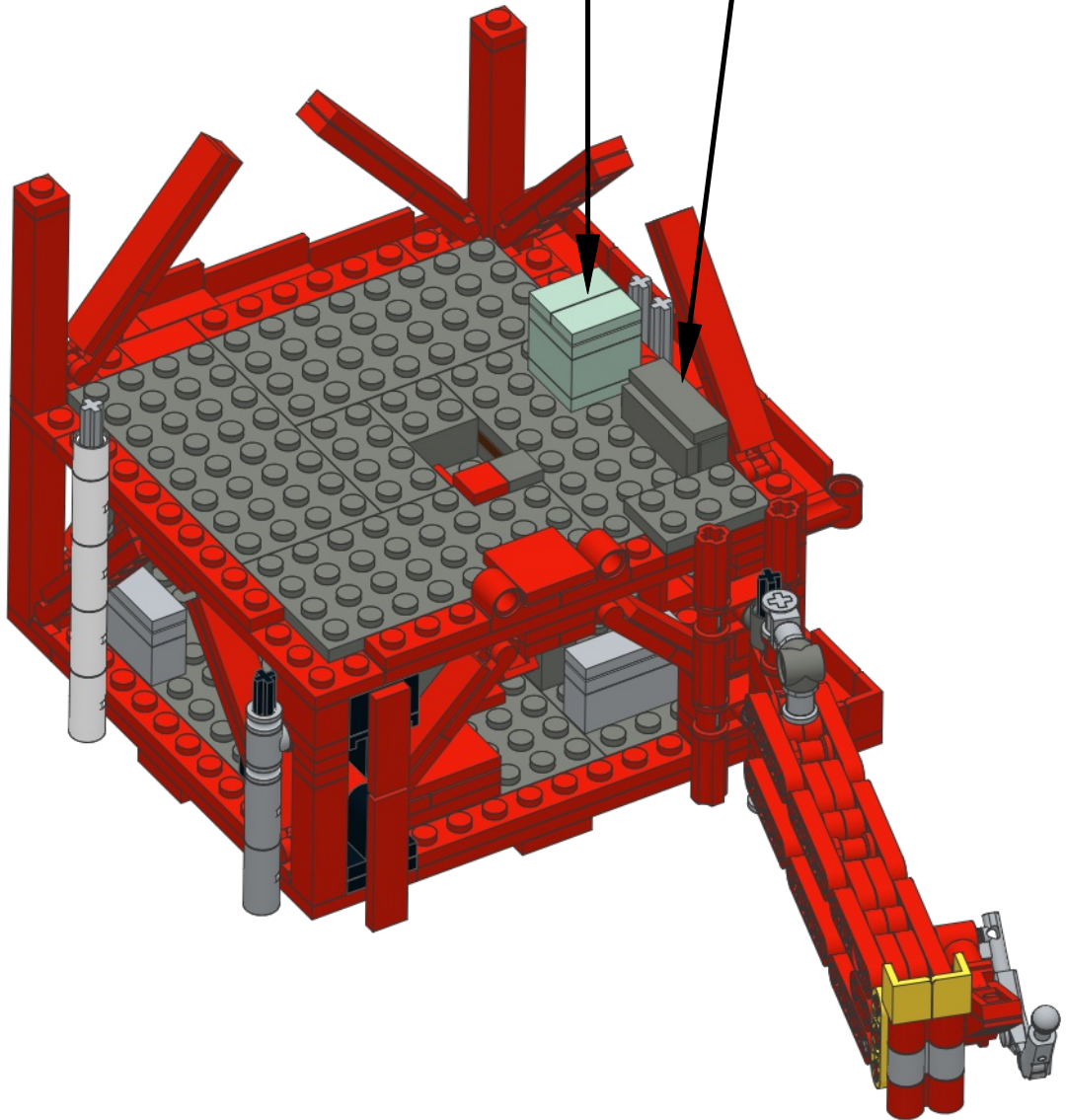
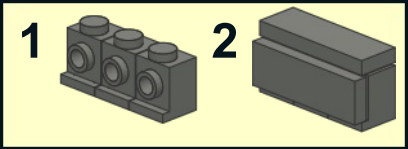
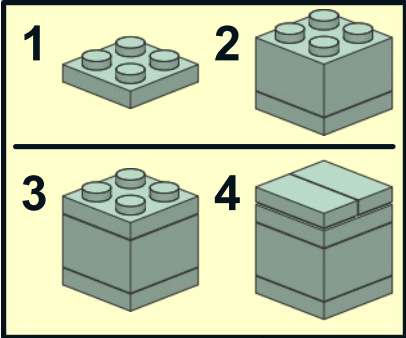
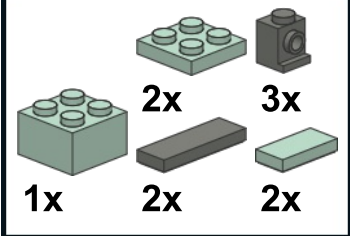



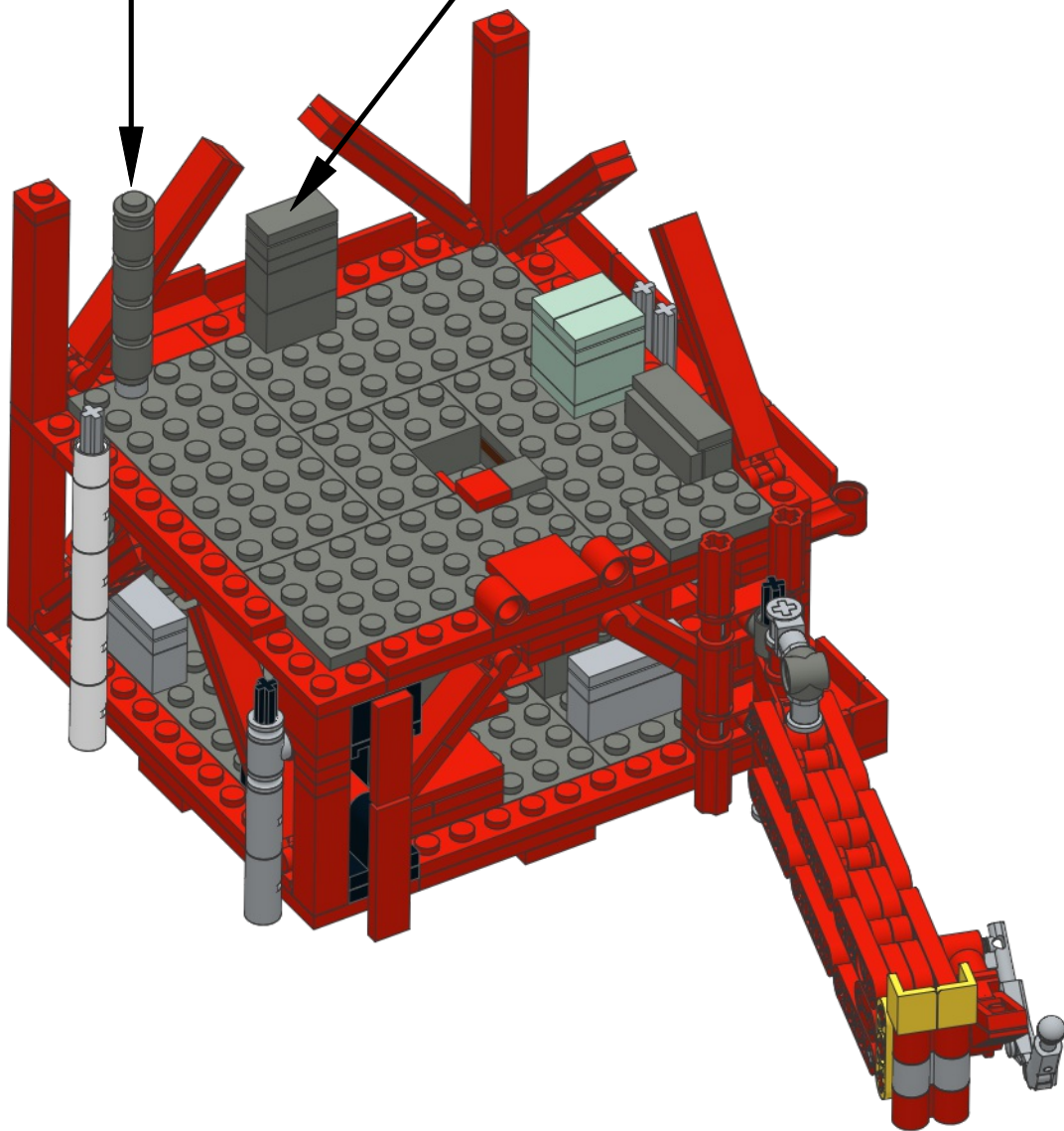
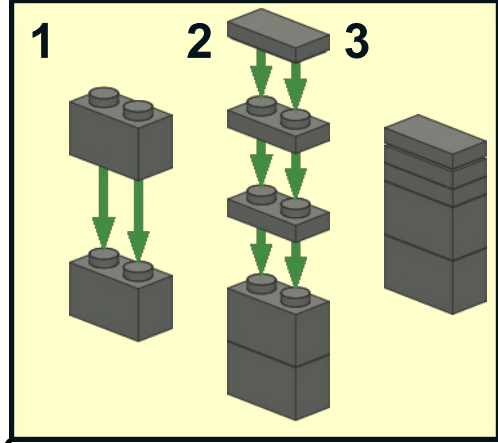
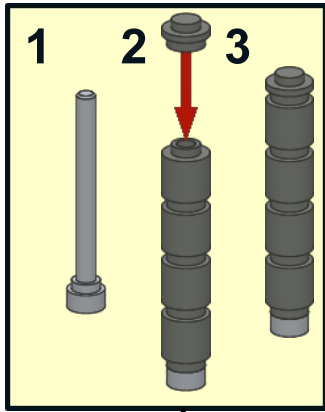
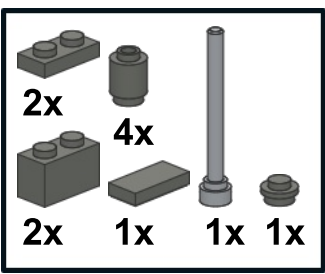





2



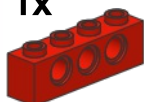
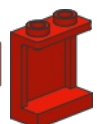

3



3

			
2x	1x	1x	1x
			
1x	1x	1x	2x
			
1x	1x	2x	8x
			
		1x	1x

1  2  3 

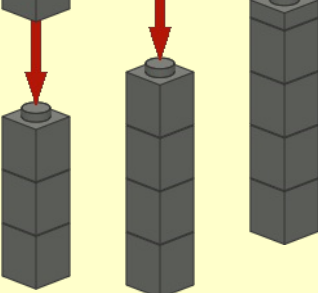

x2

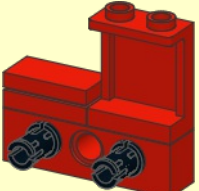
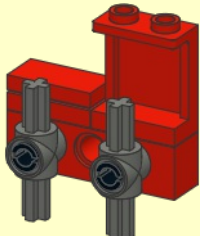
1  2  3 

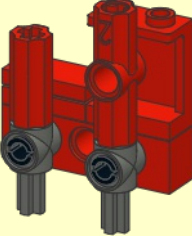
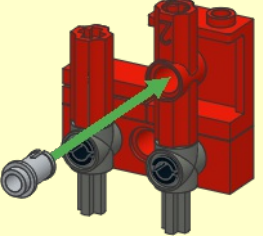
4  5 

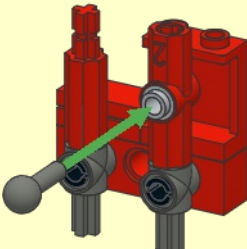
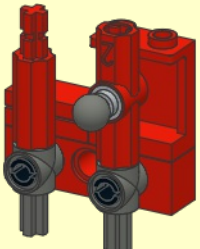
6  7 

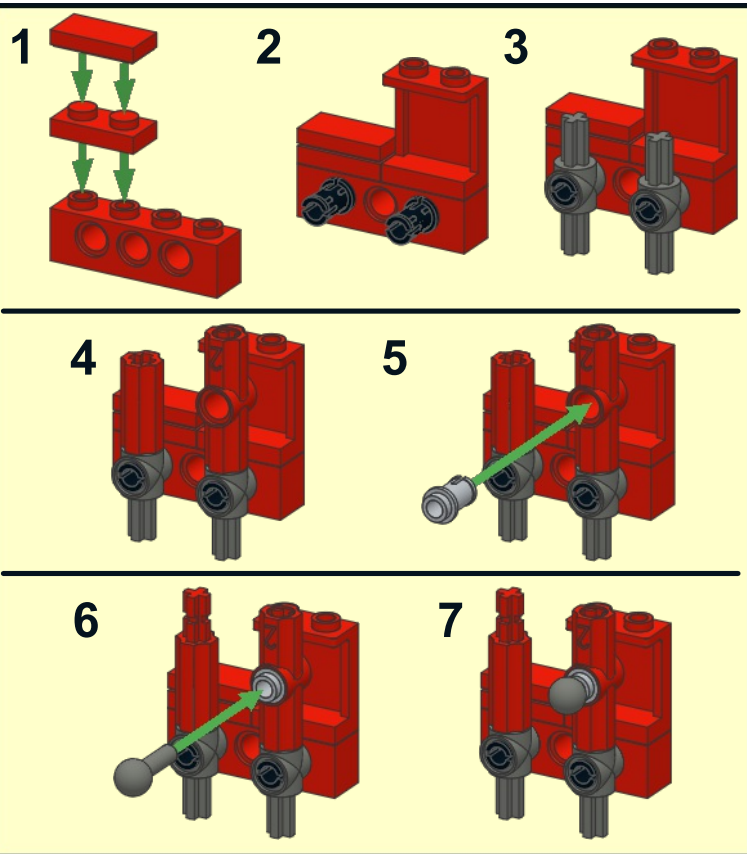
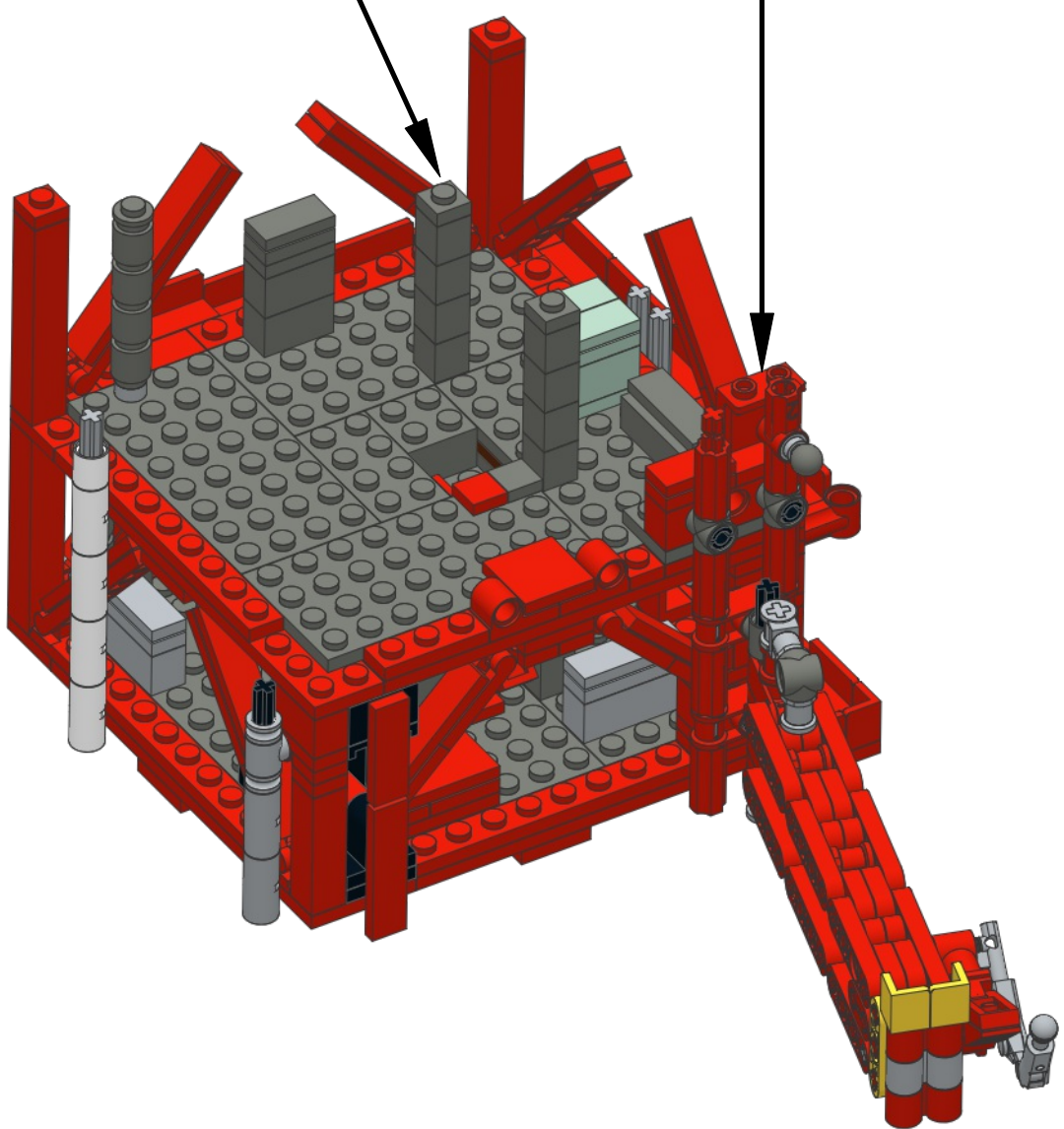

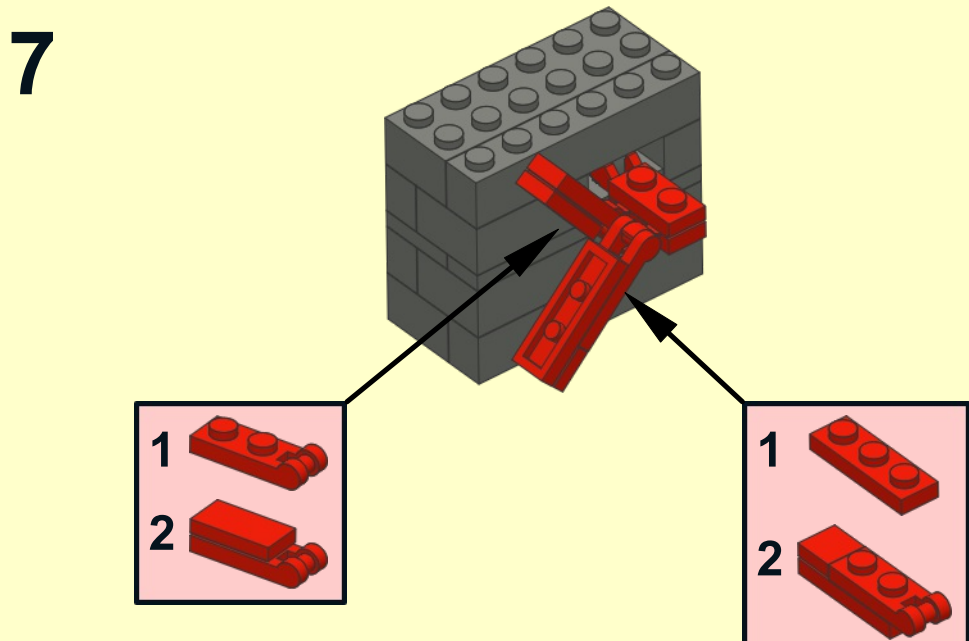
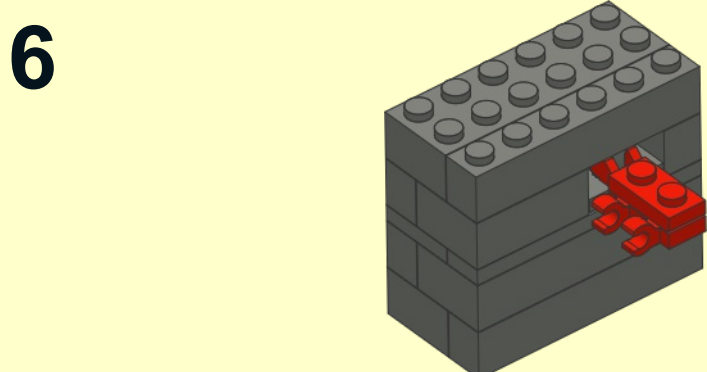
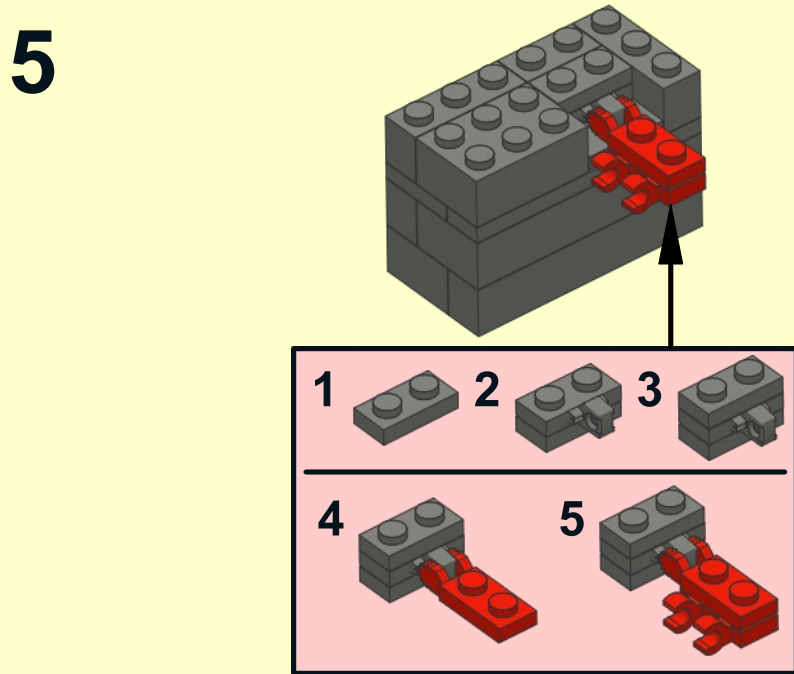
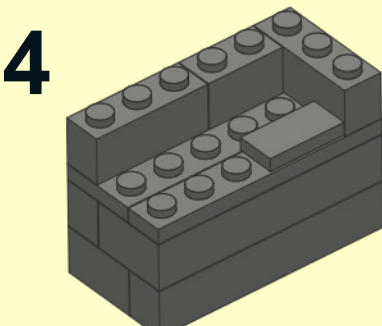
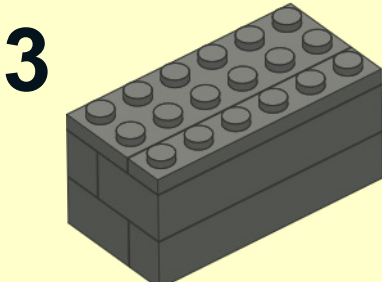
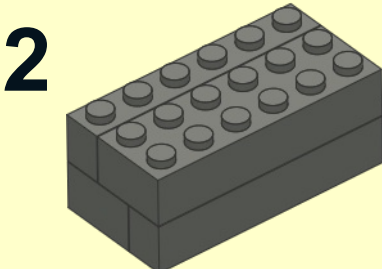
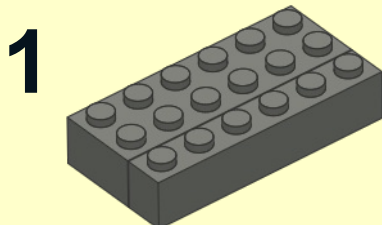
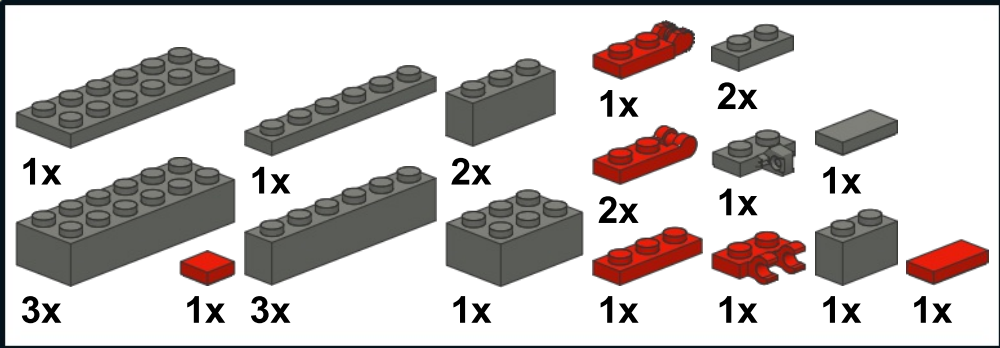
5

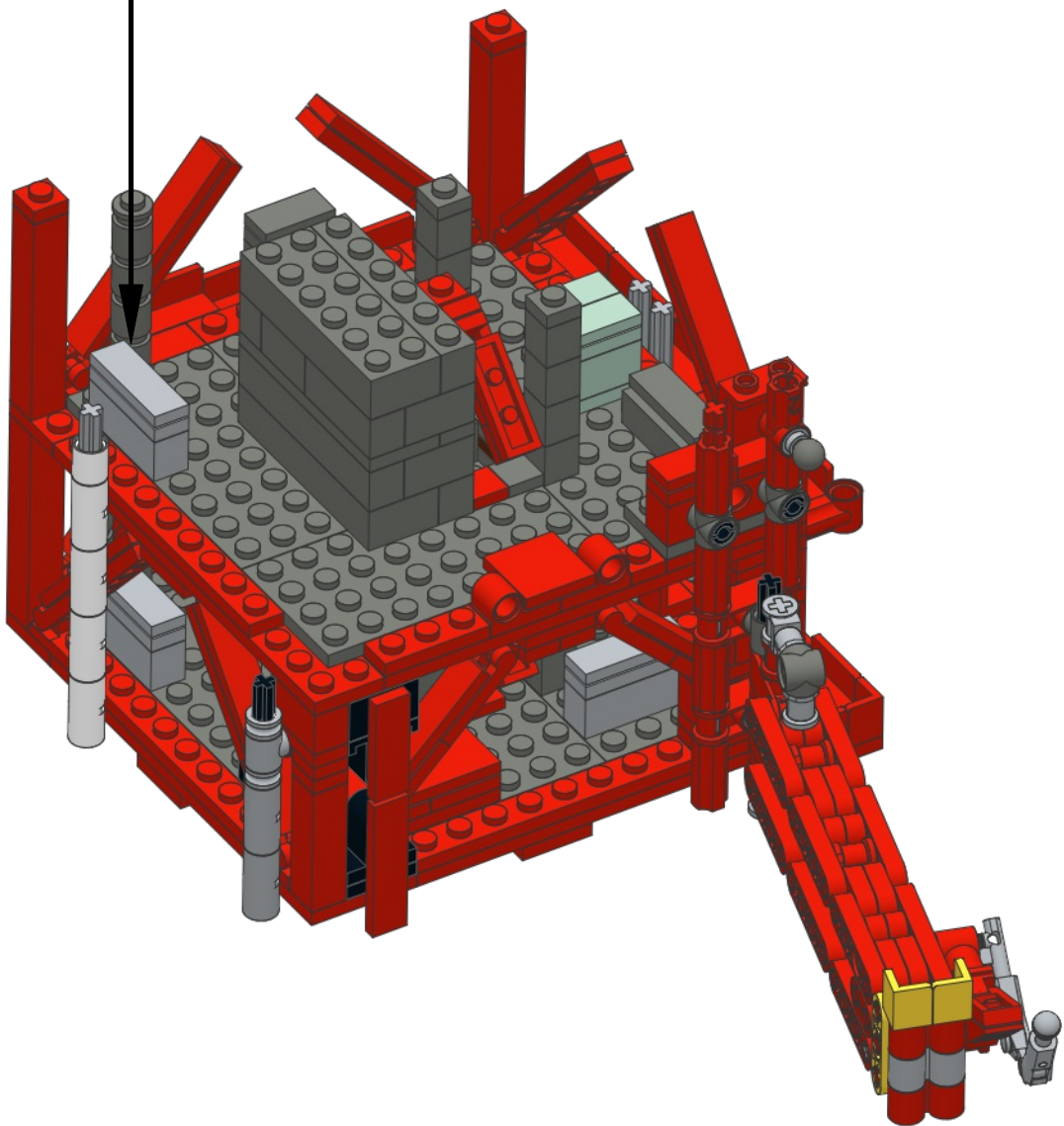
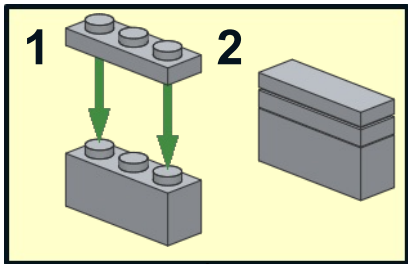
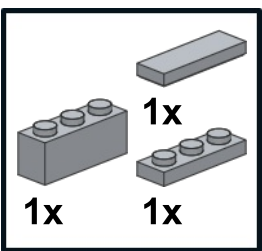

6

6

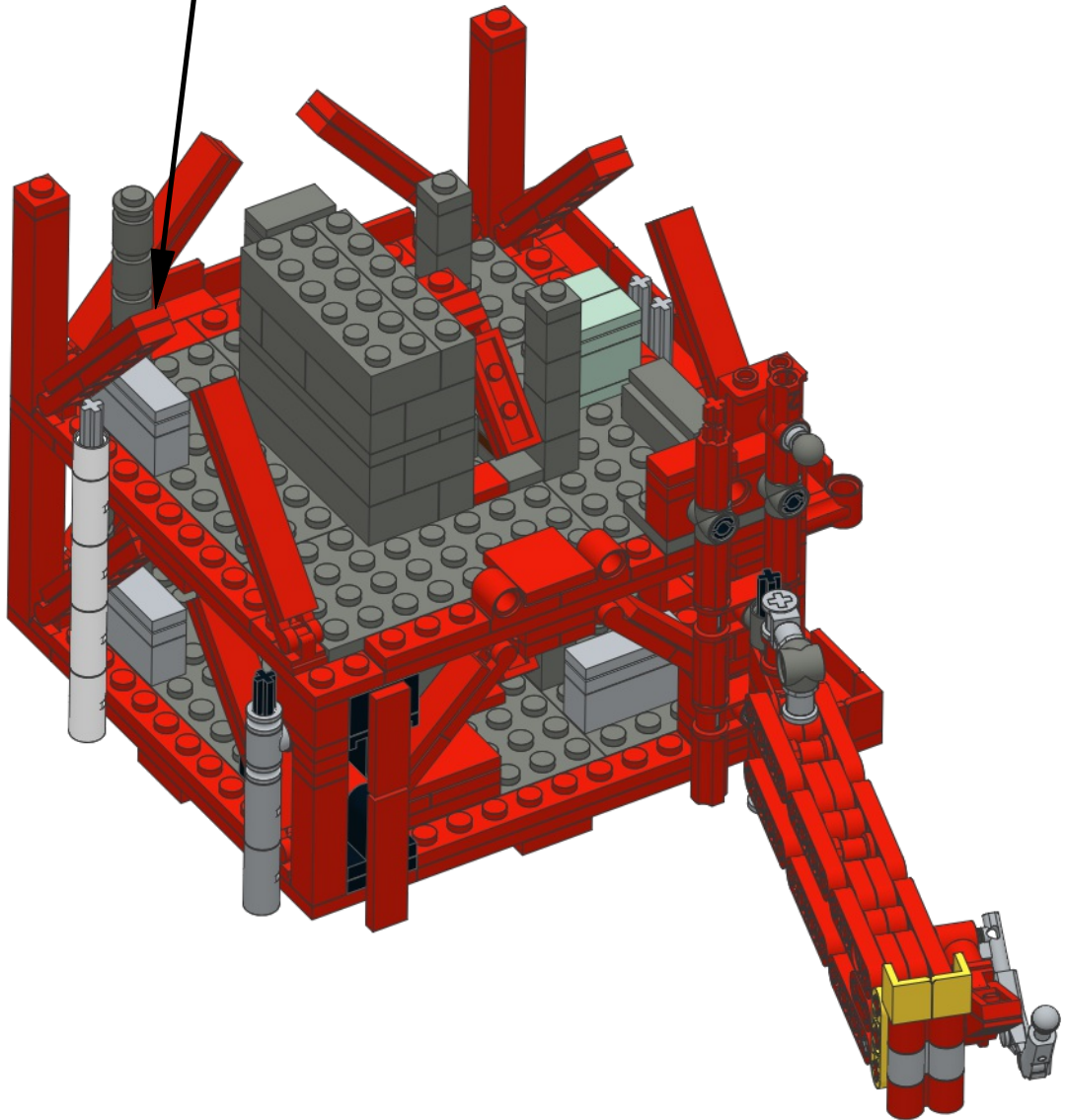
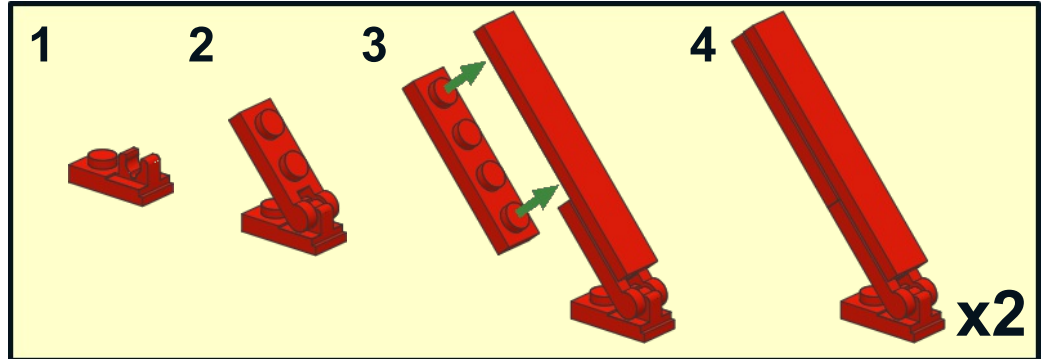
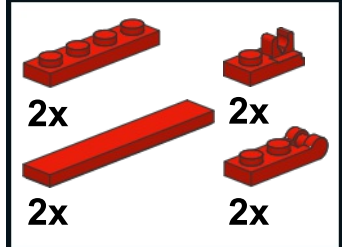

7



7

2x	2x	1x	1x
2x	2x	1x	1x

1

2

3

4

5

6

7

8

8

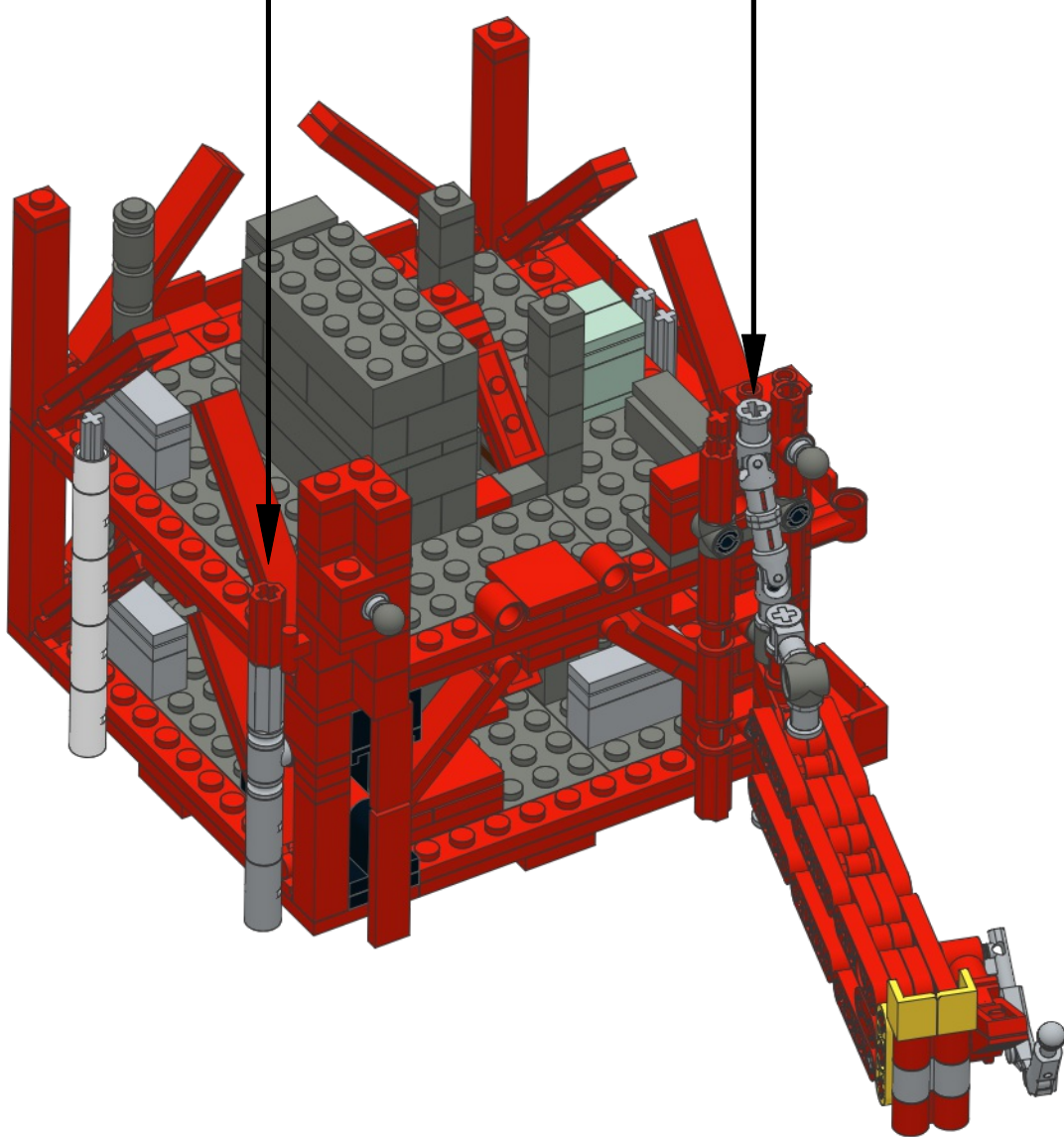
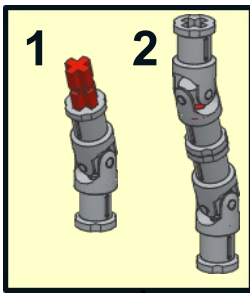
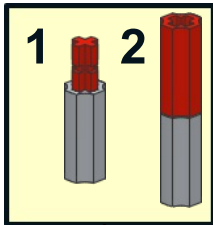

9

9

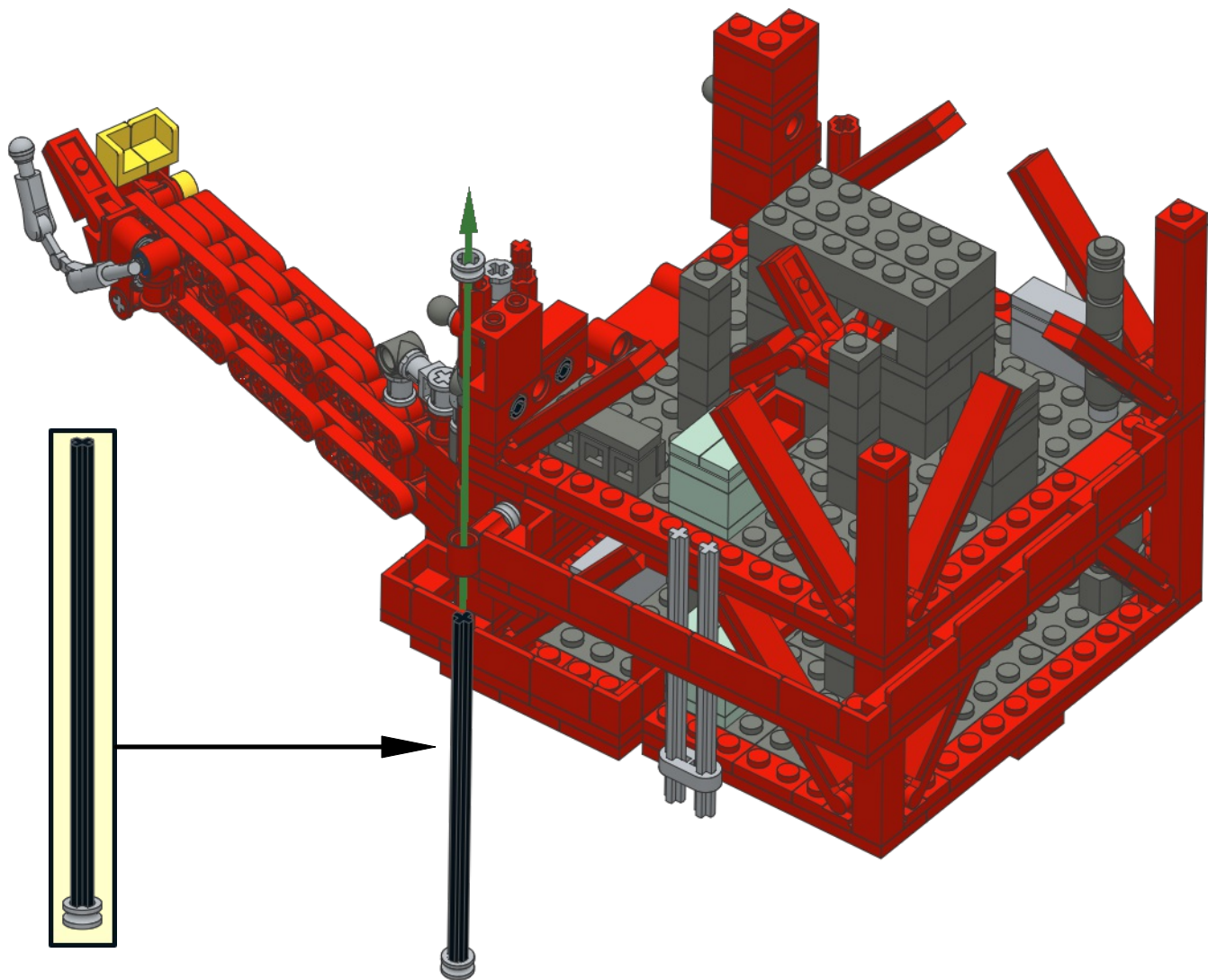
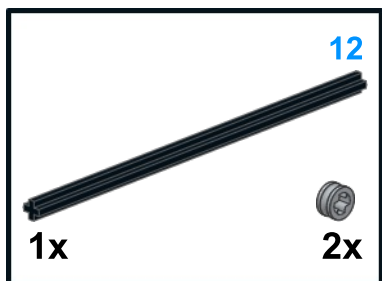

**1**

1x 4x 1x

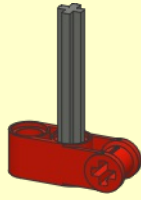

**2**

2x

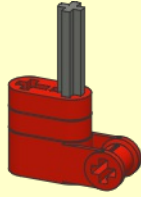

**3**

1x 2x

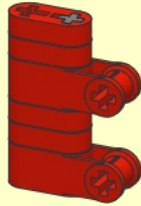

**4**

2x 4x 2x

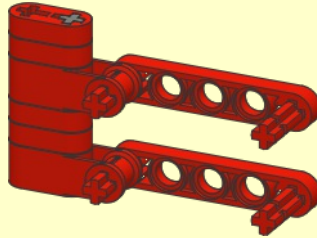

**5**

4x

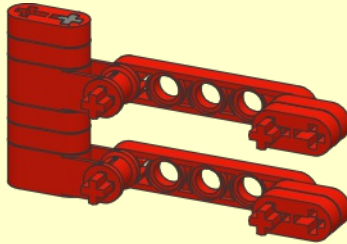

**6**

4x 3x 2x

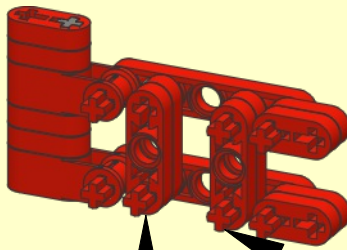

**1** **2**

**1** **2**

**7**

2x 2x

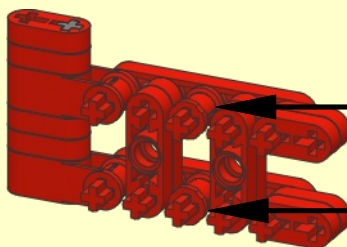

**1** **2**

x2

8  2x

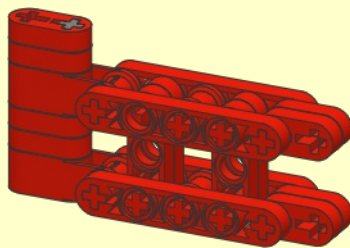

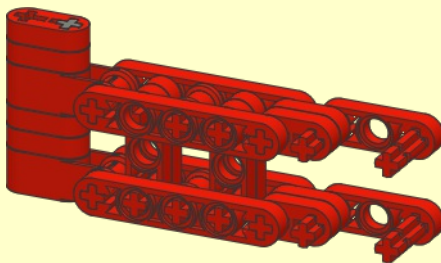

9  2x  4x

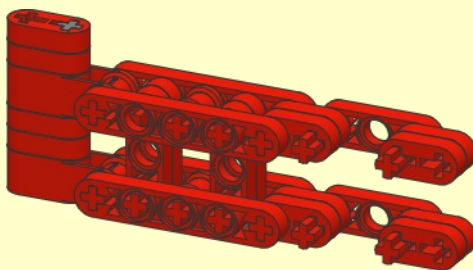

10  4x

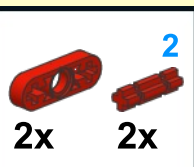

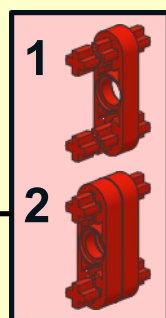
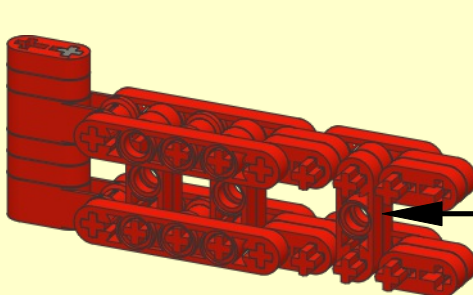

11  2x  2x

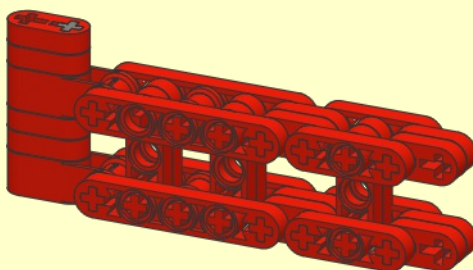

12  2x

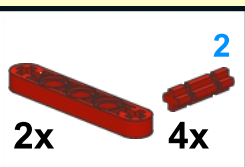

13  2x  4x

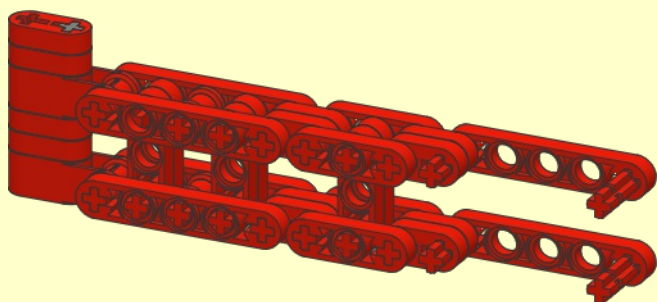

14  4x

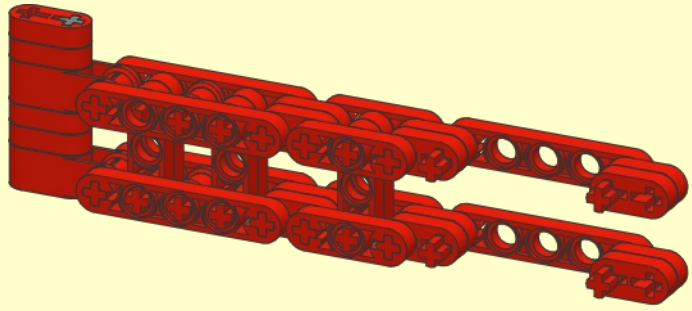

15  2x  4x  2x

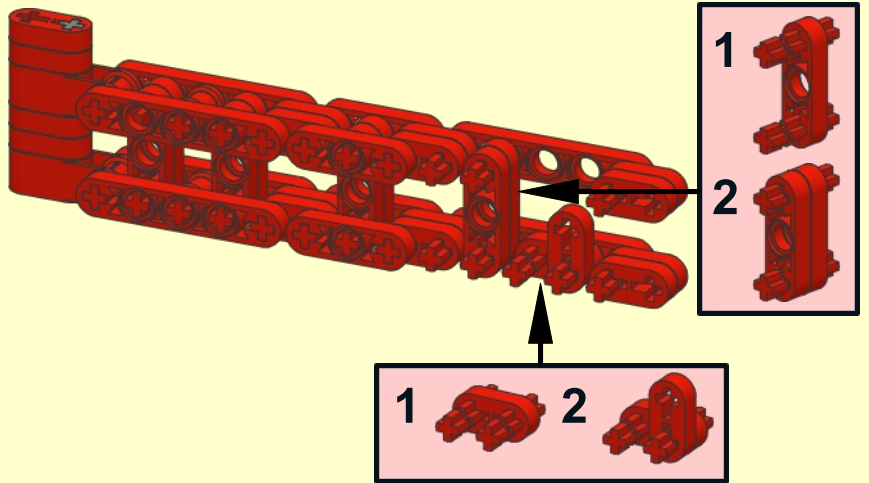

16  12  2  1x  2  2x  2x  1x

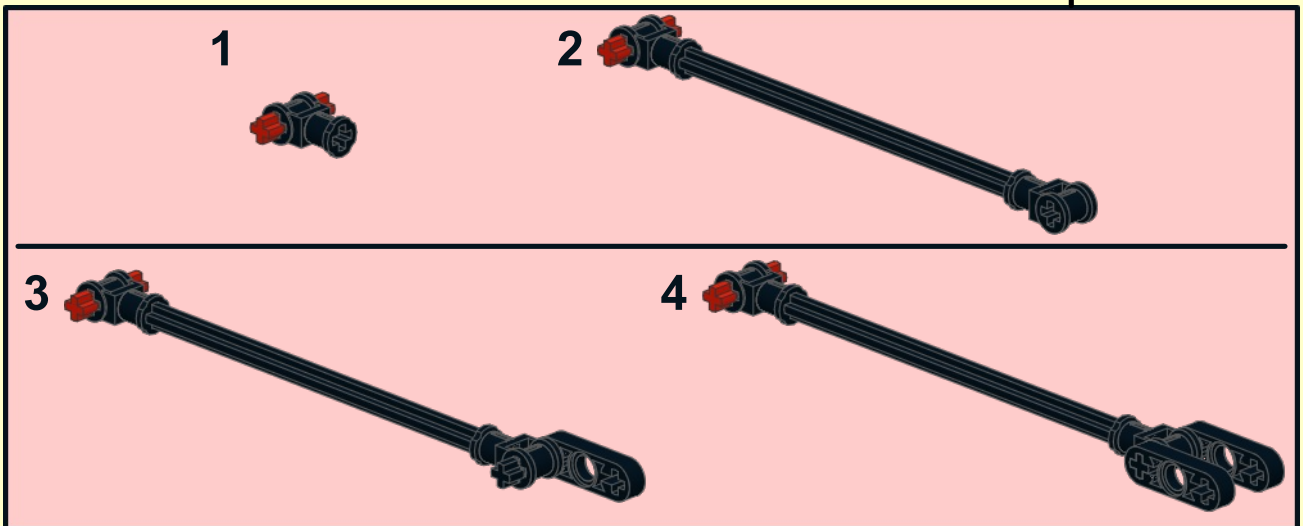
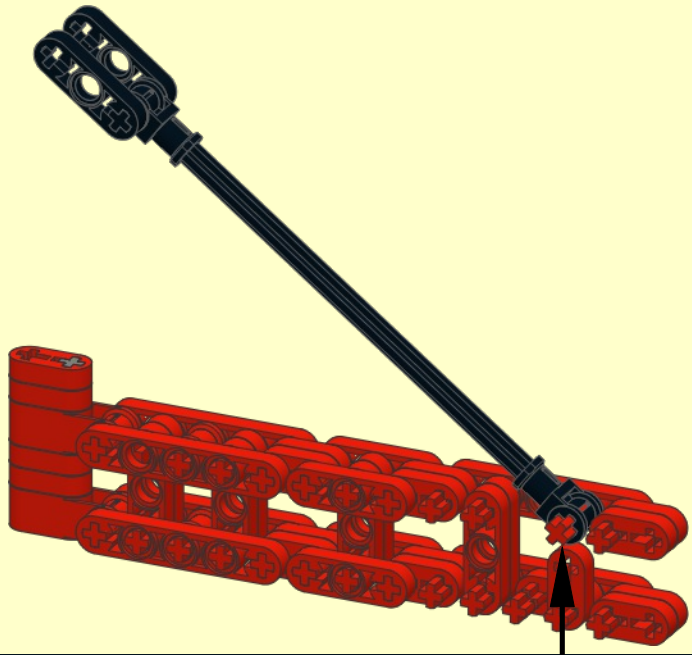

17

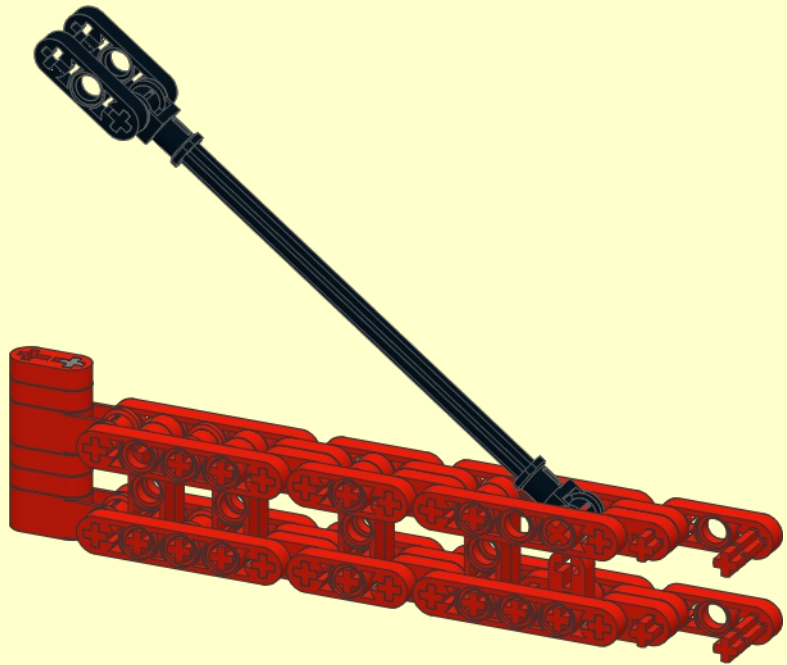
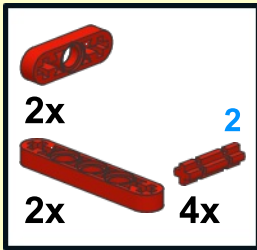

18

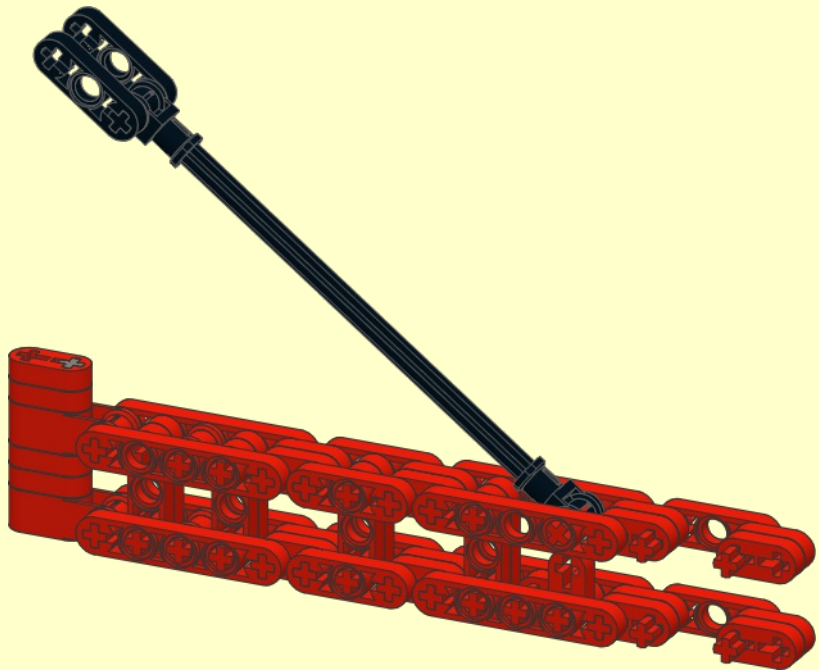

19

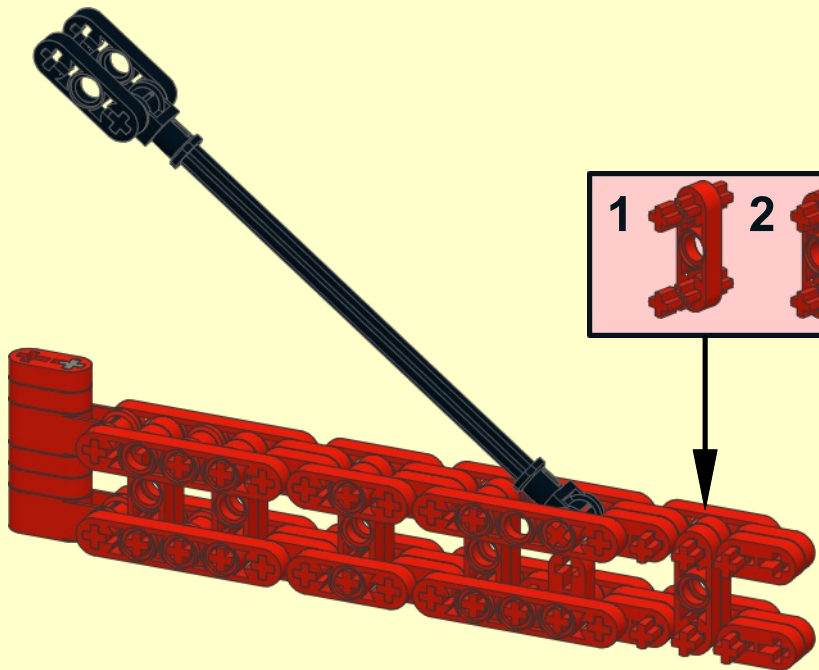
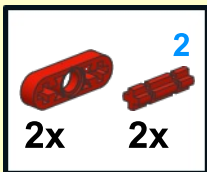

20  2x

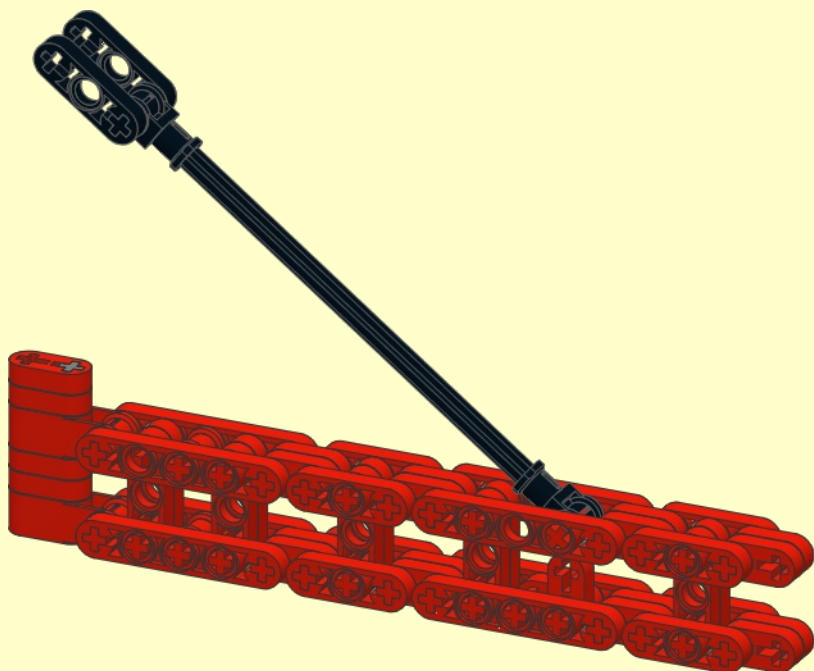

21  1x  1x  2

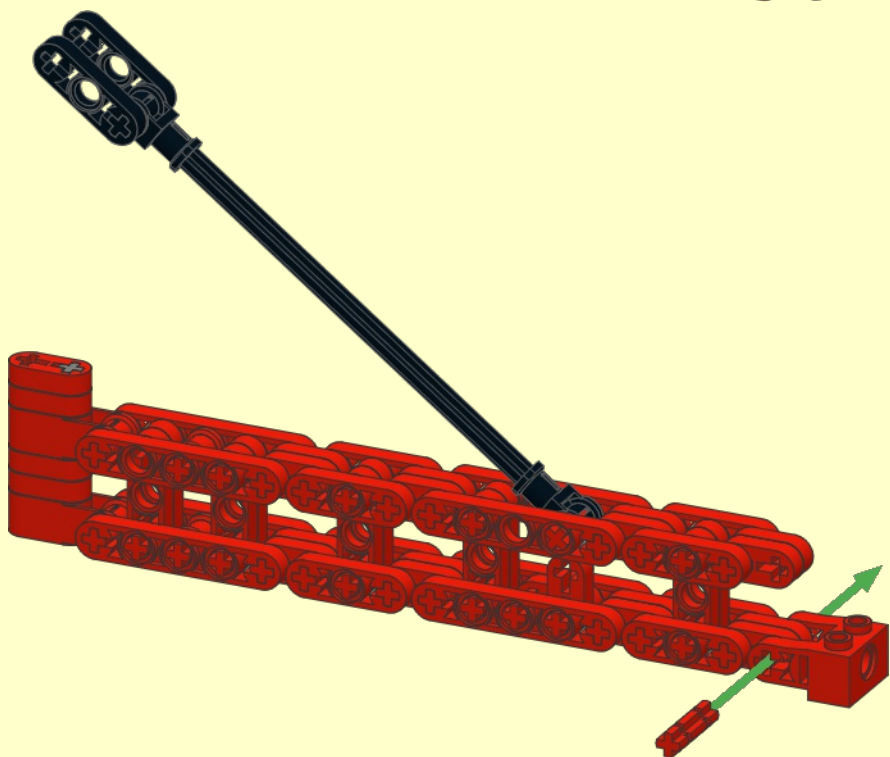

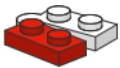
22  1x  2x

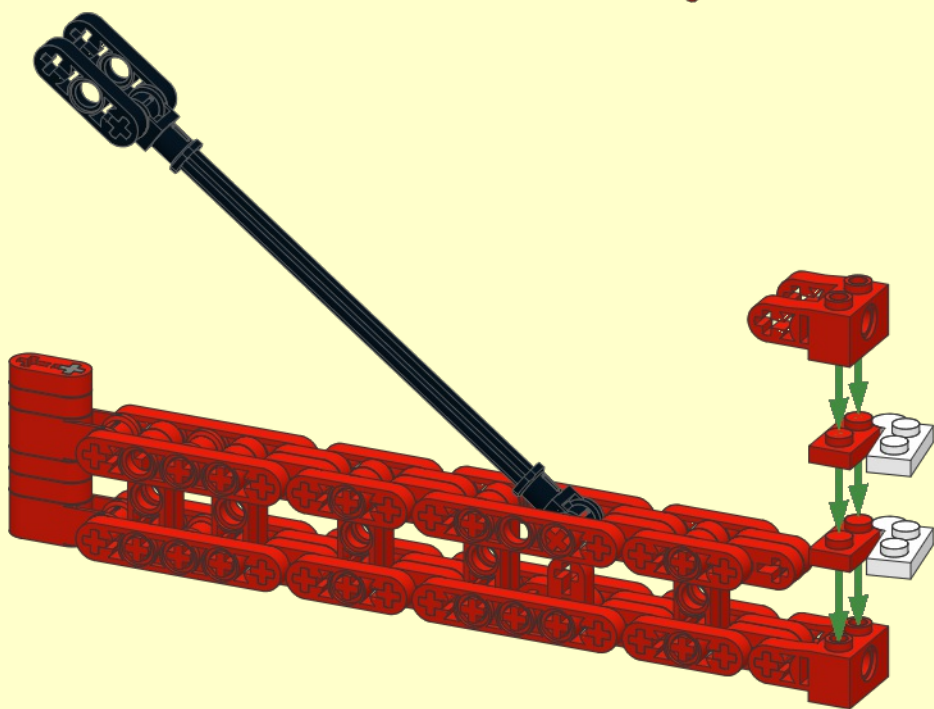



23

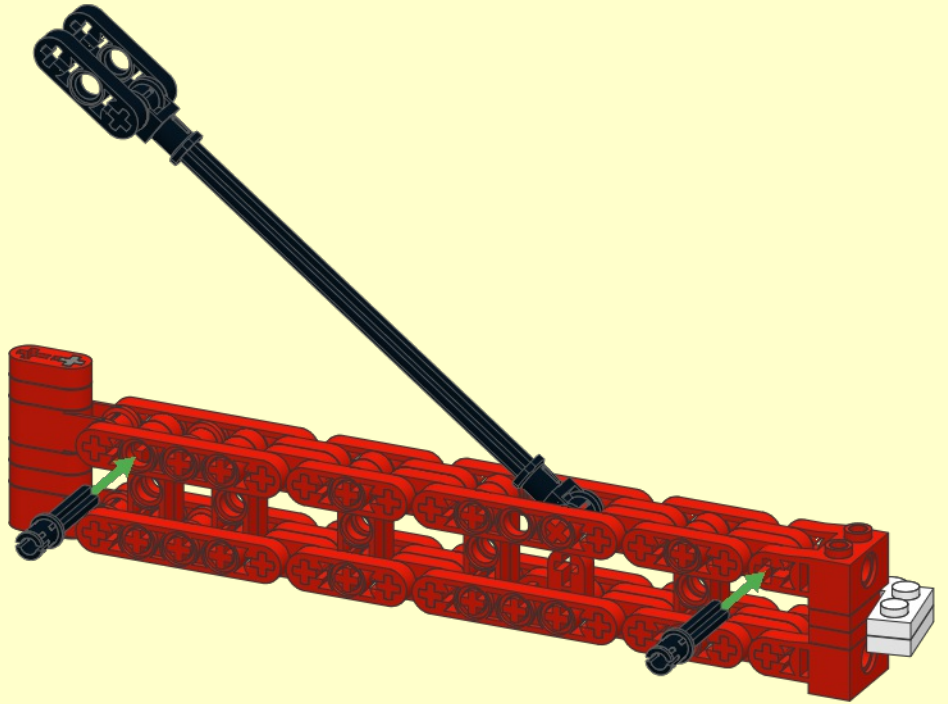

24

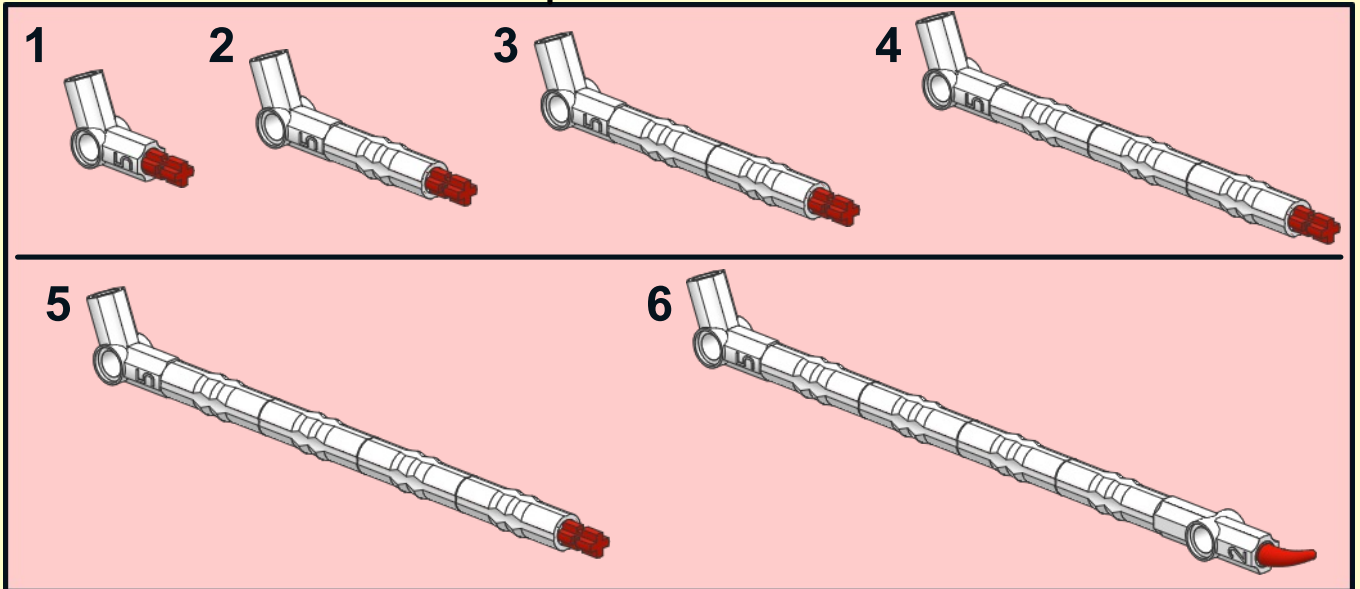
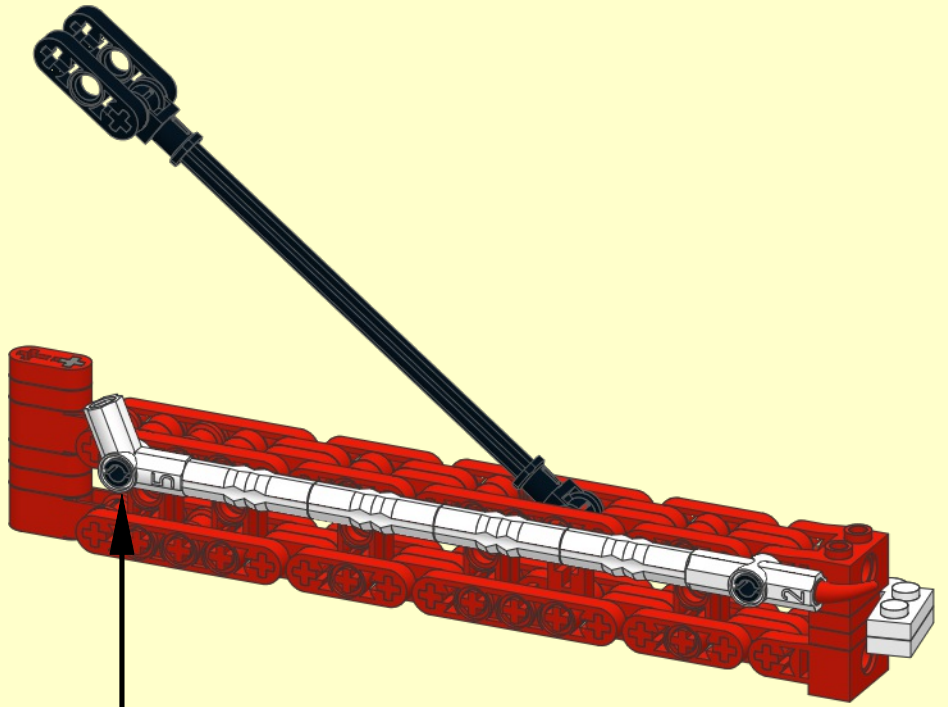
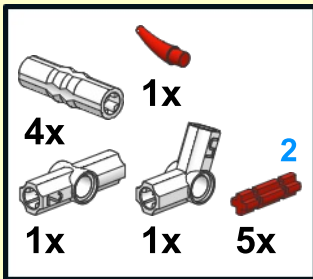

25

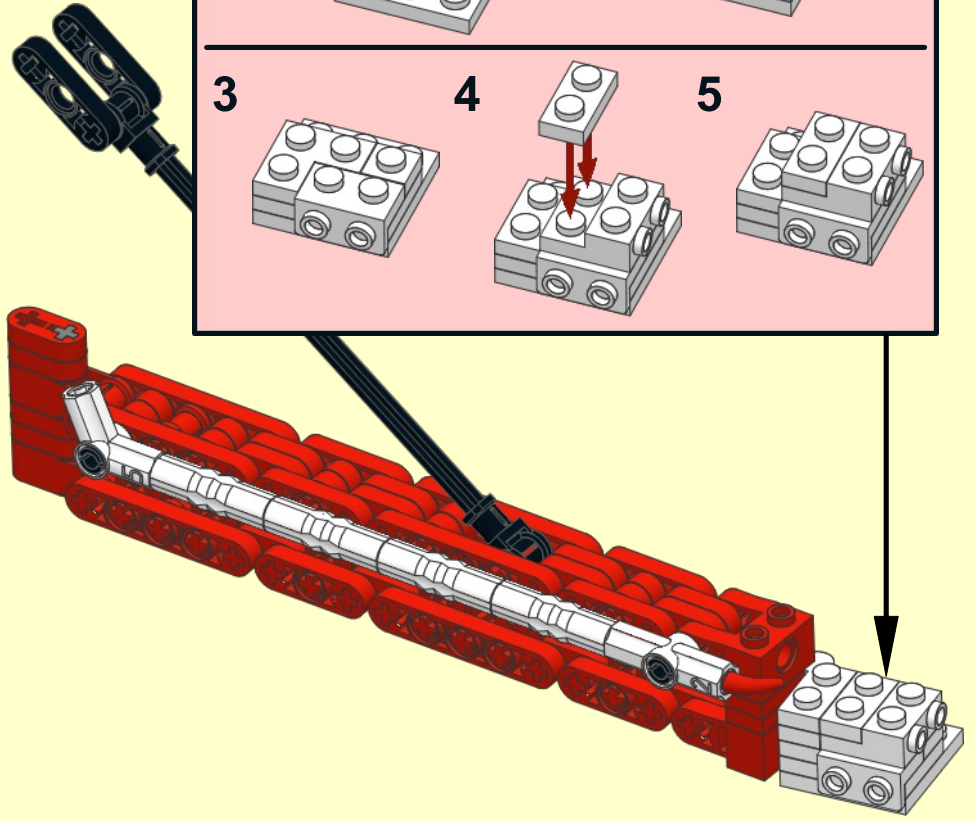
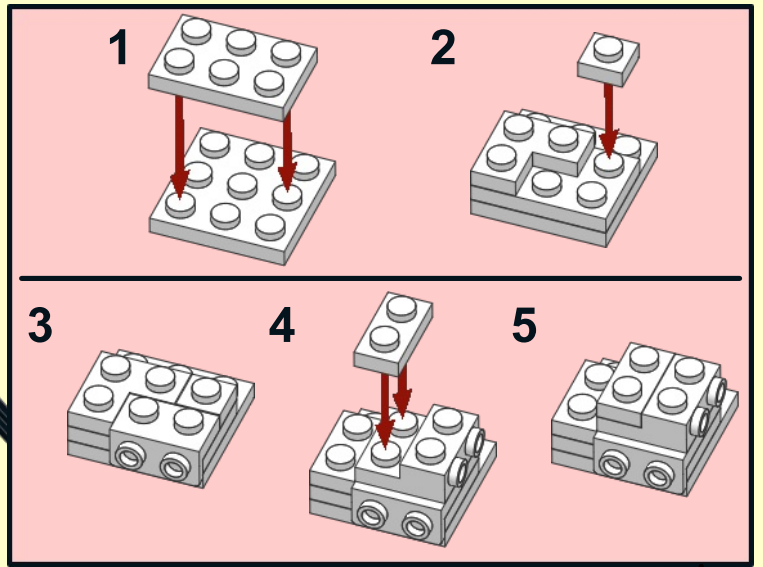
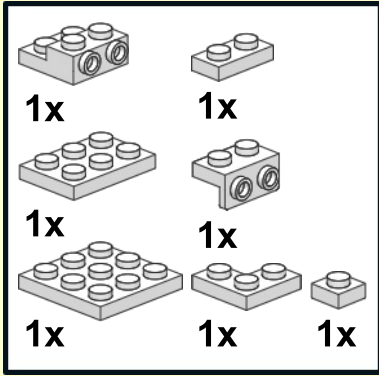

26

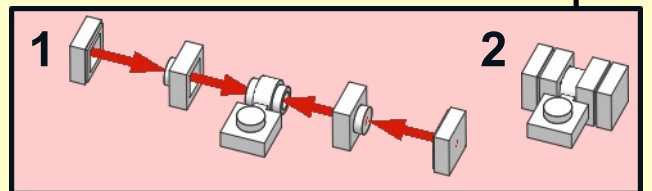
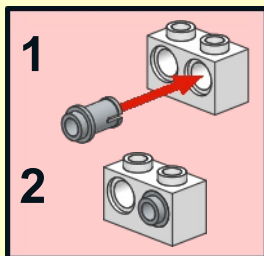
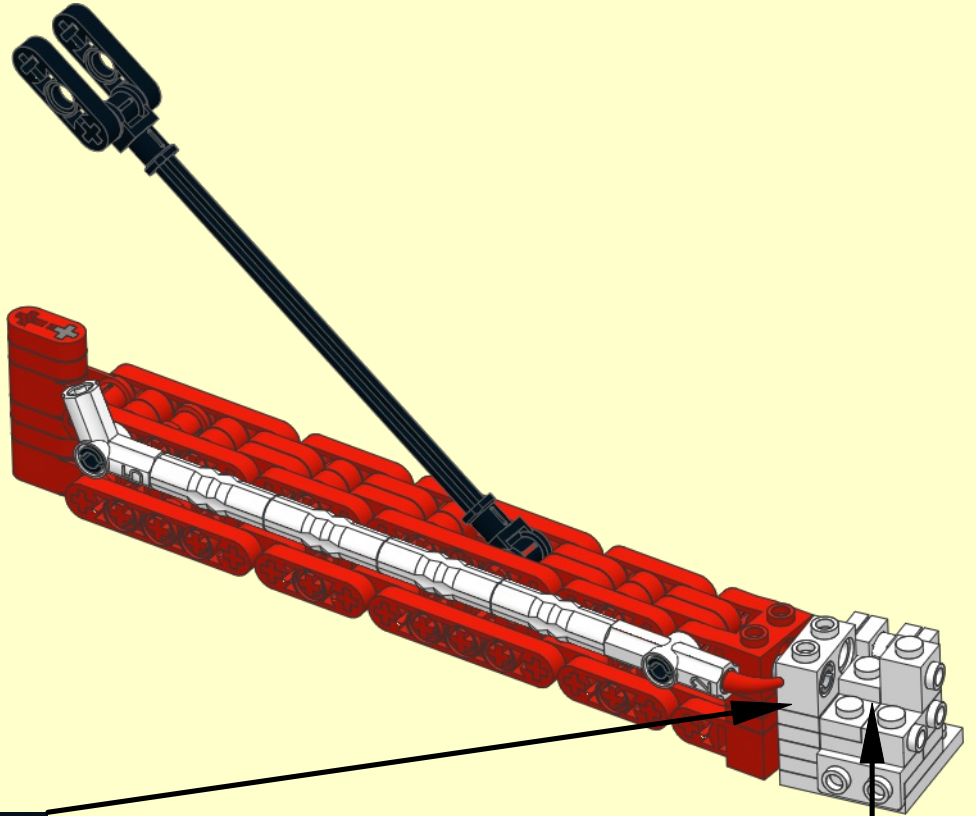
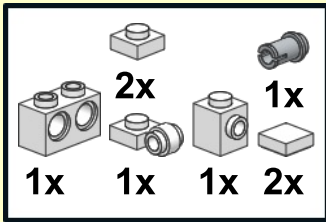

27

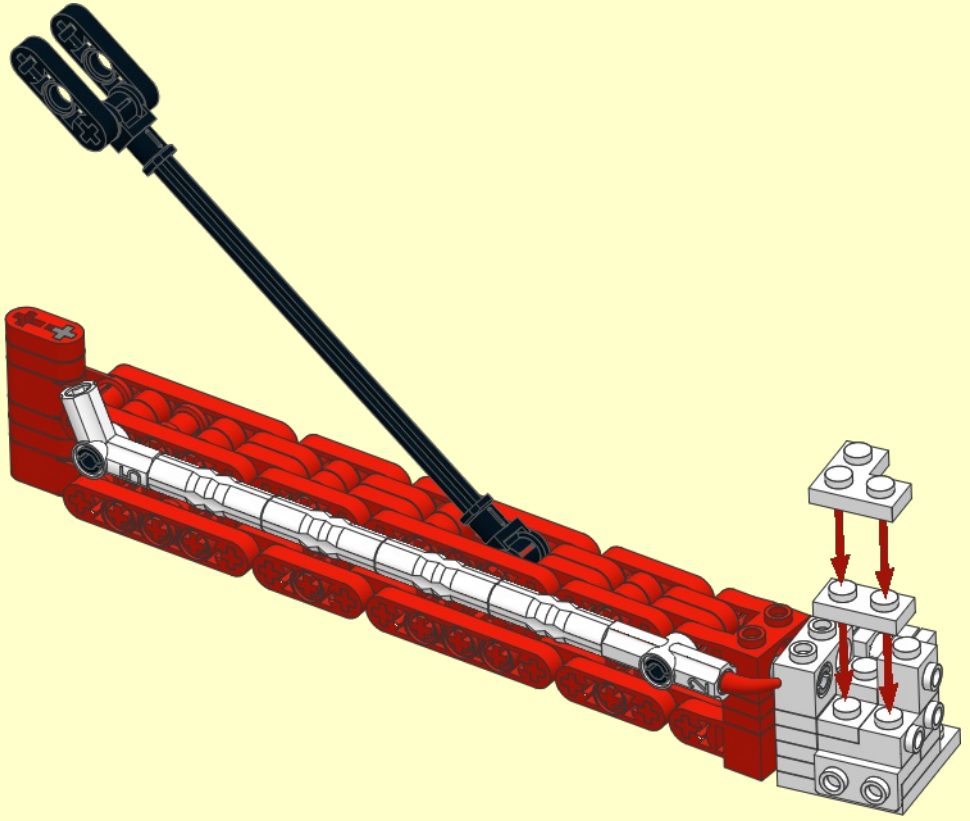
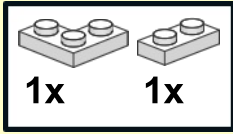

28

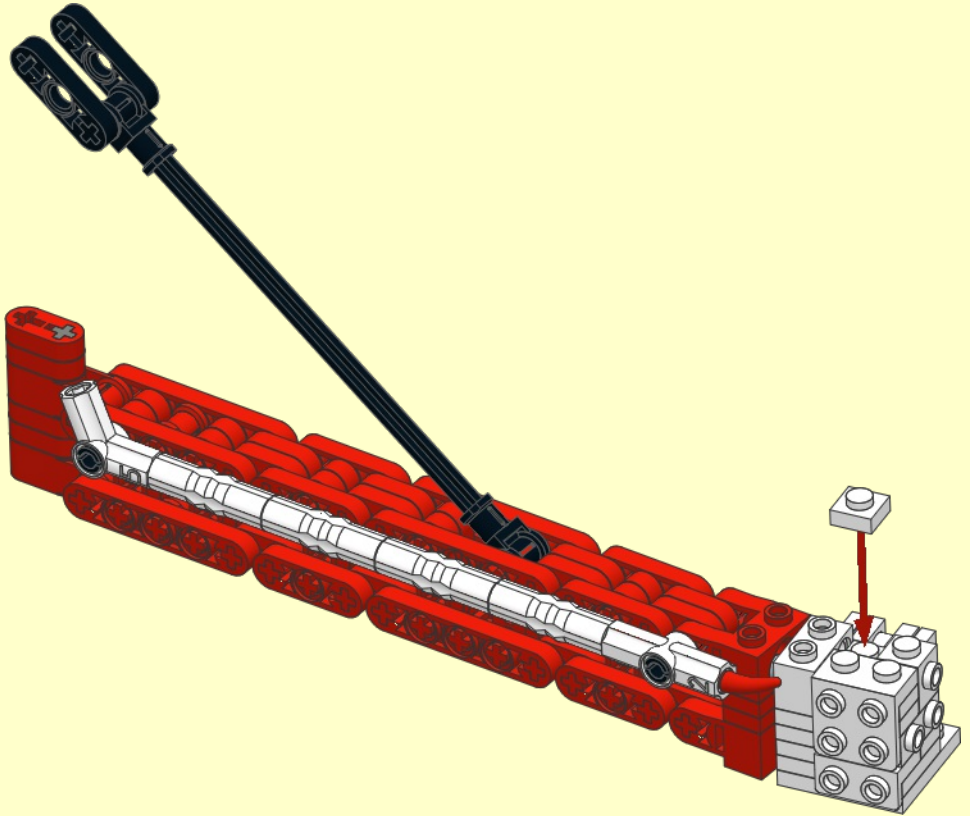
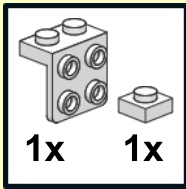

# 29

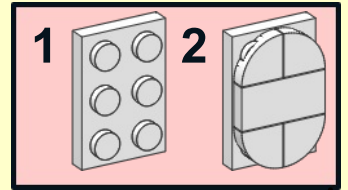
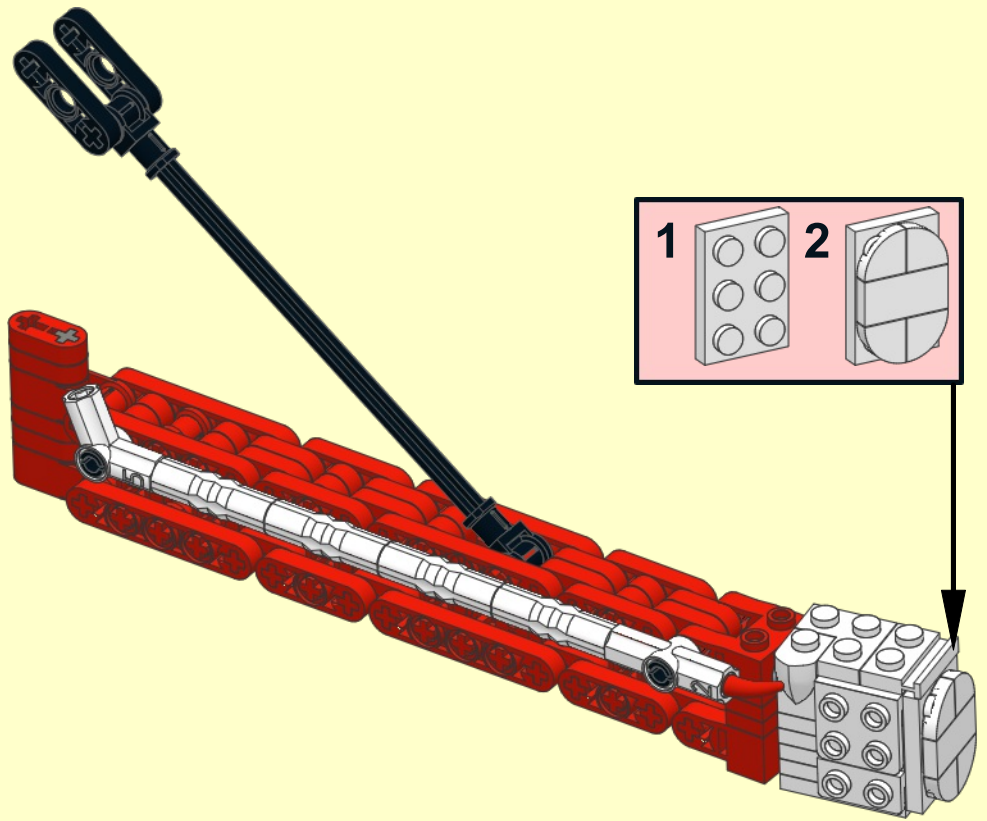
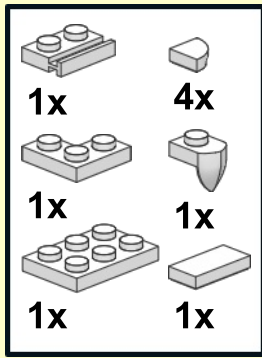

# 30

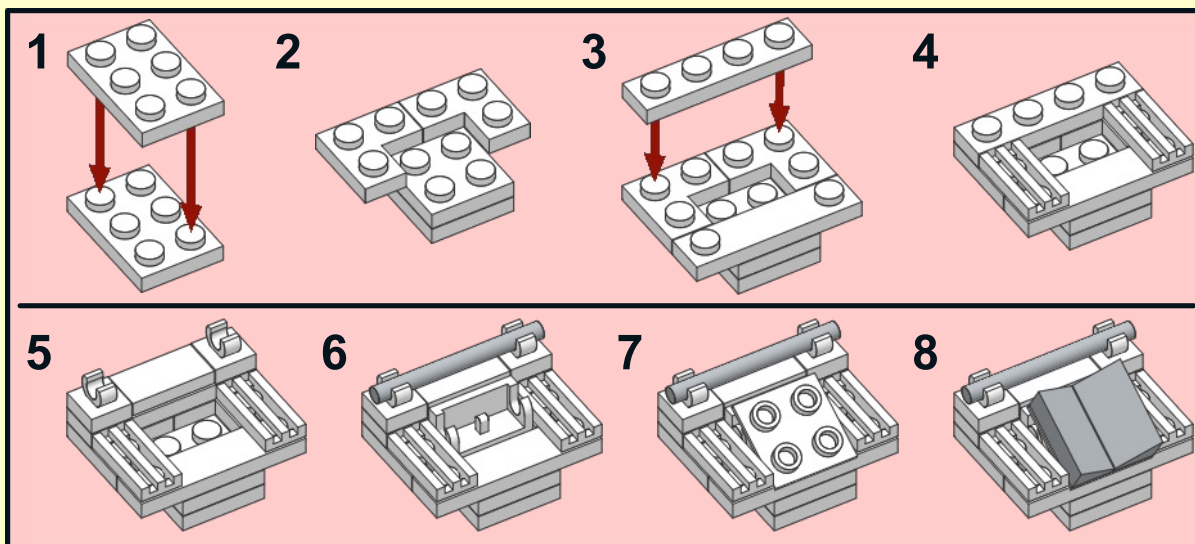
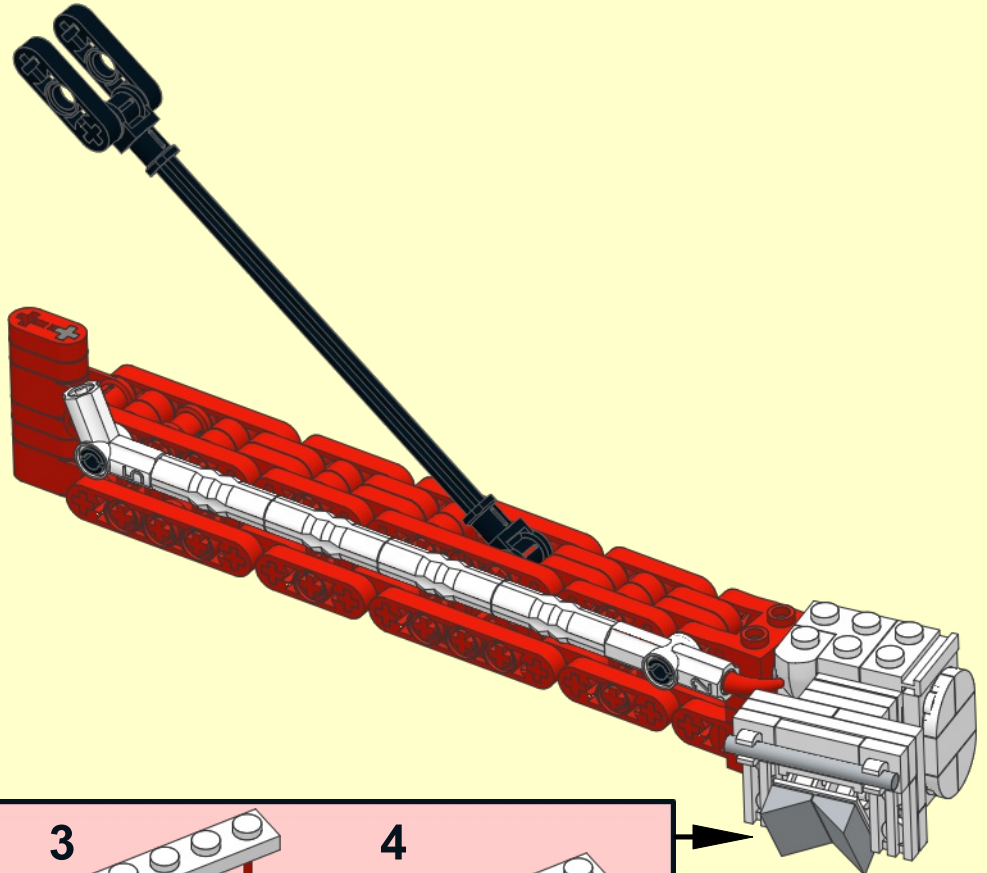
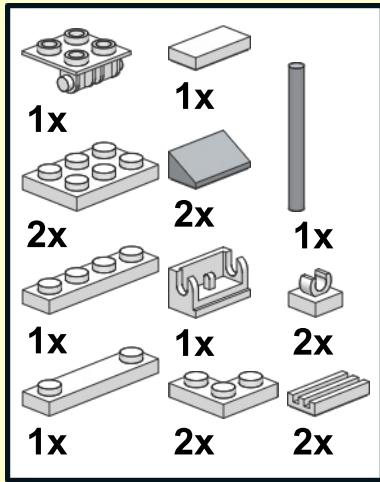

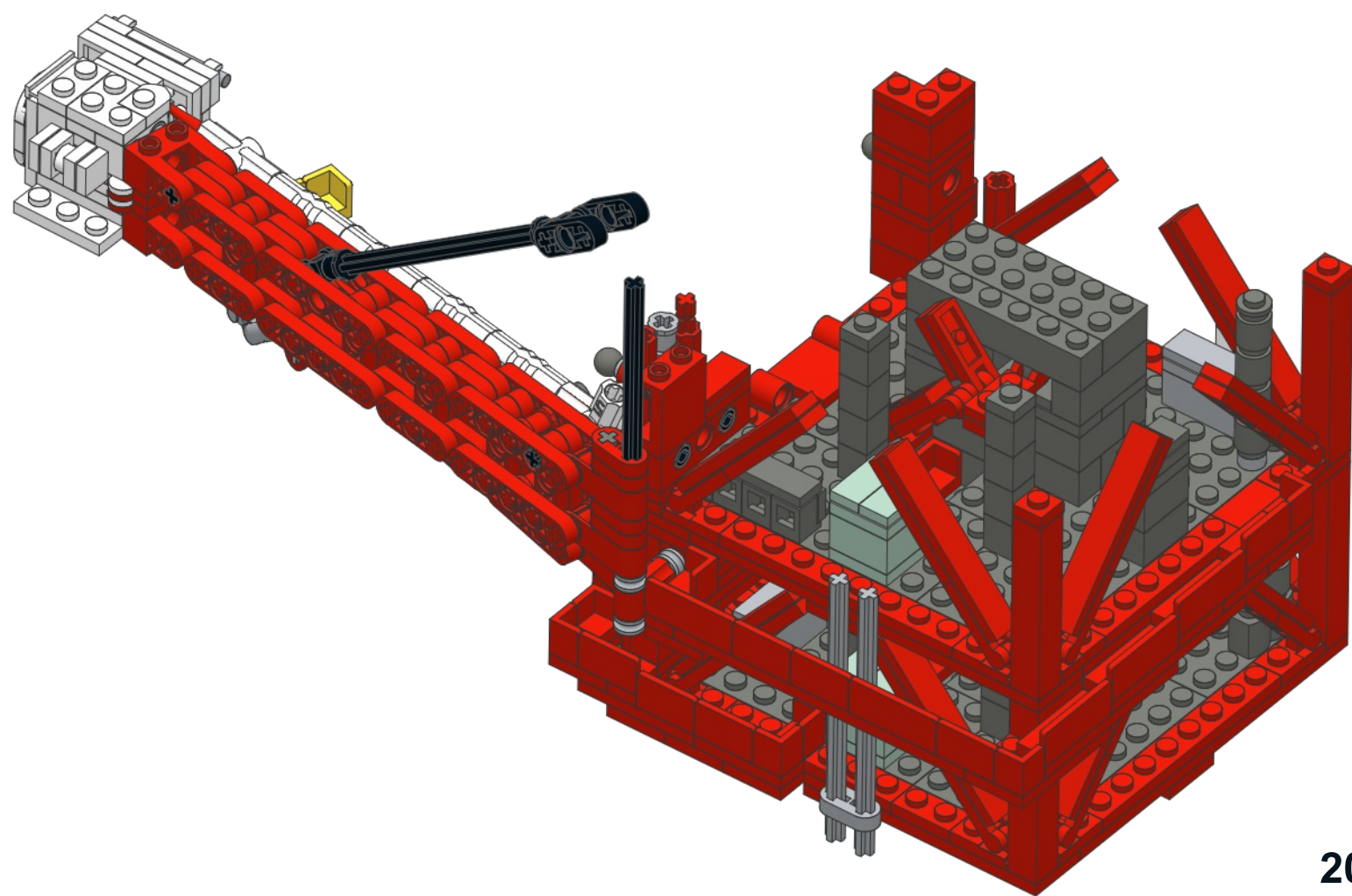

1

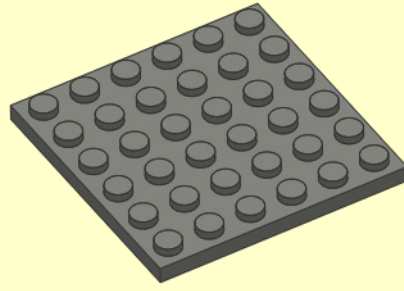
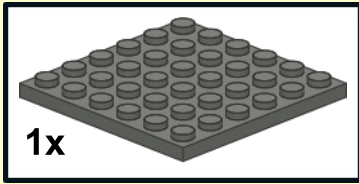

2

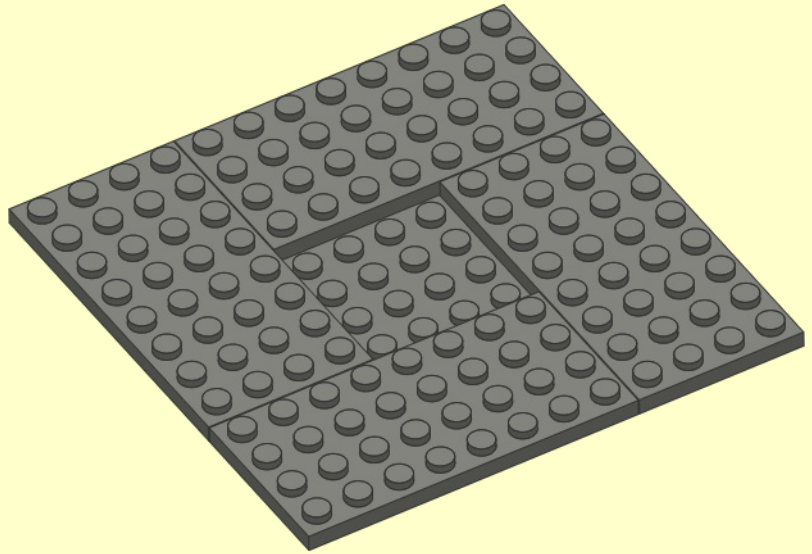
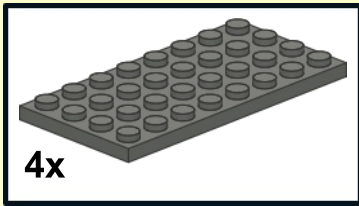

3

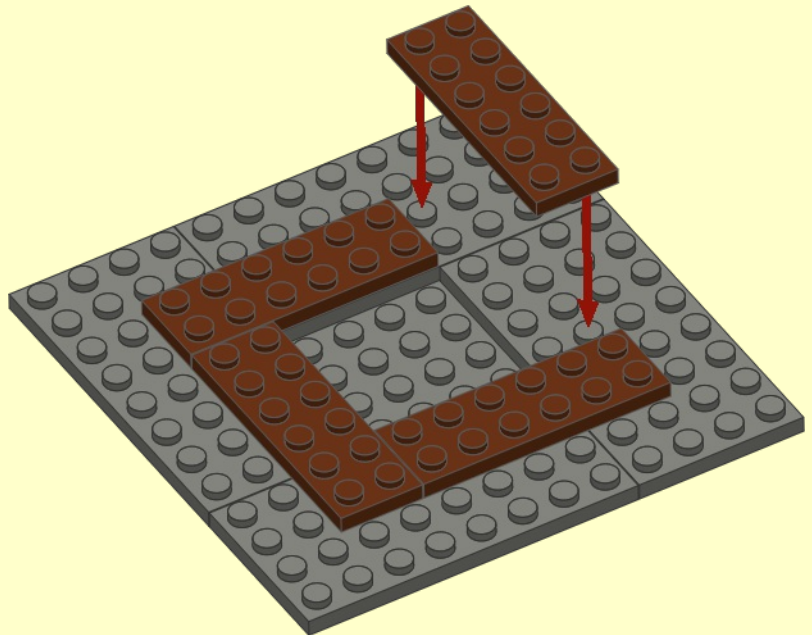
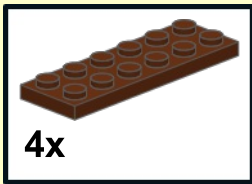

4

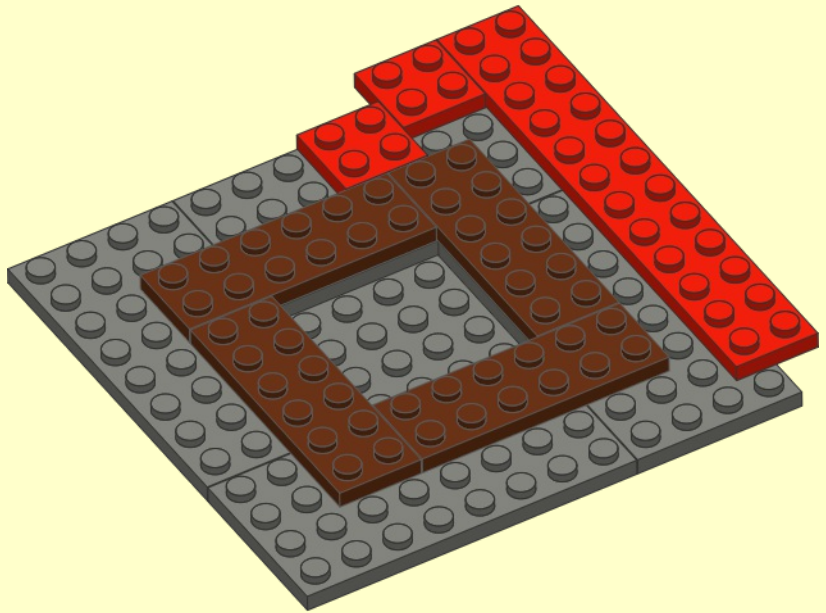
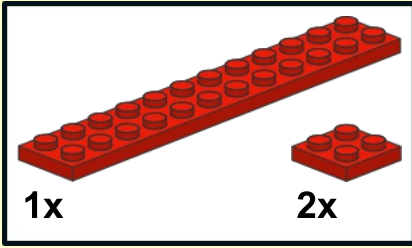

5

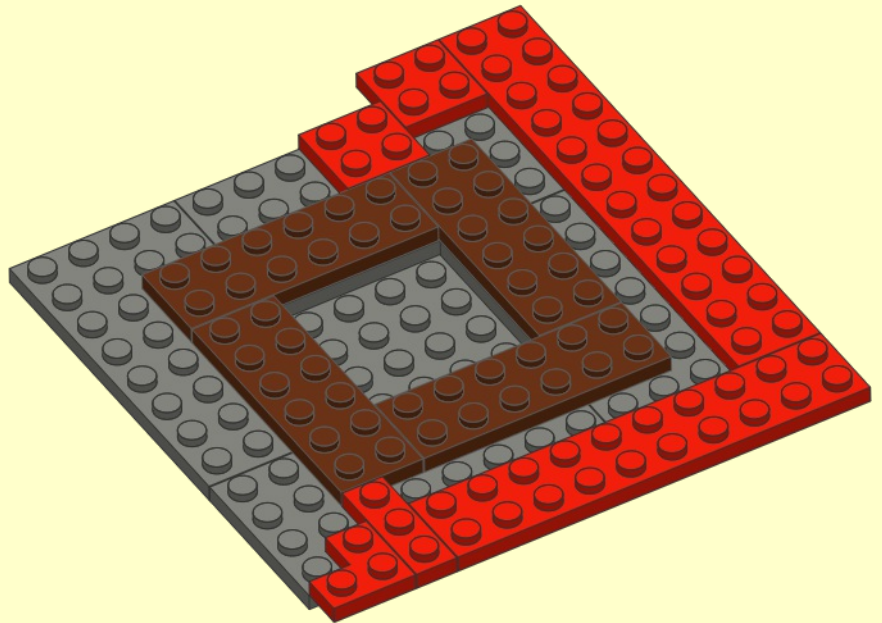
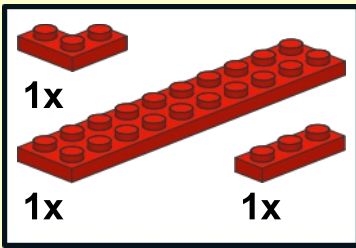

6

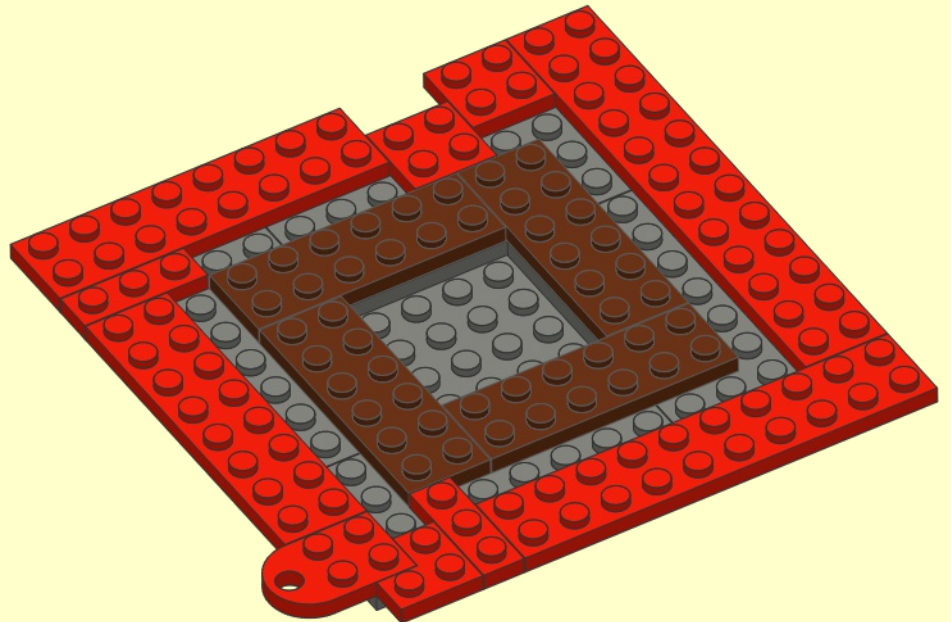
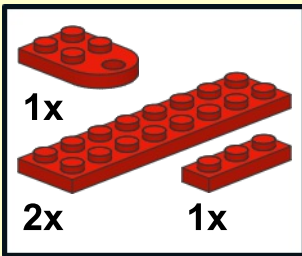

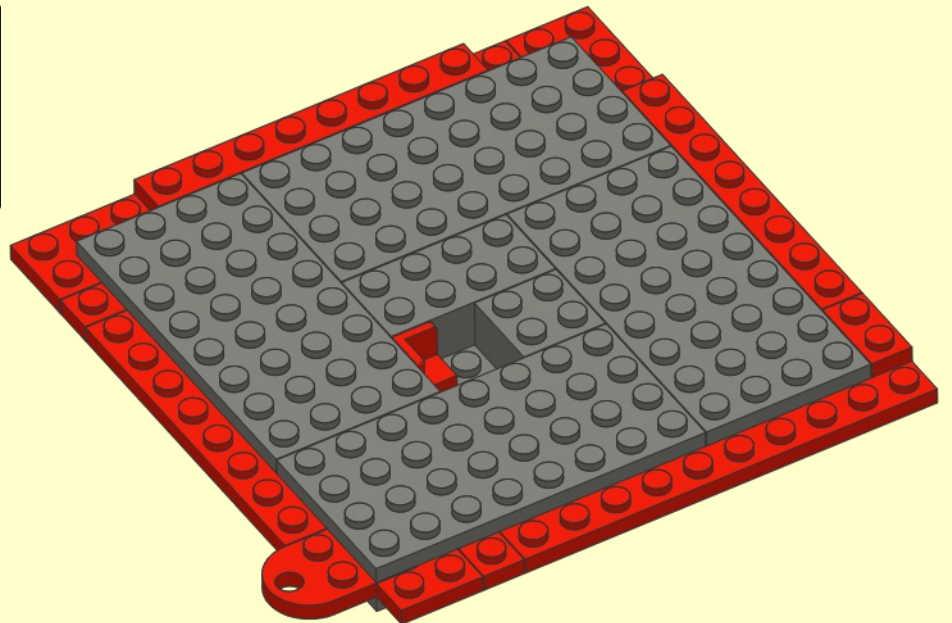
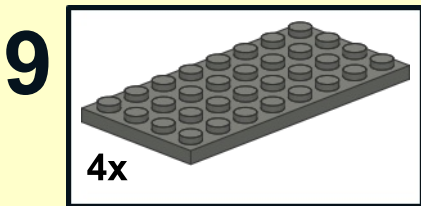
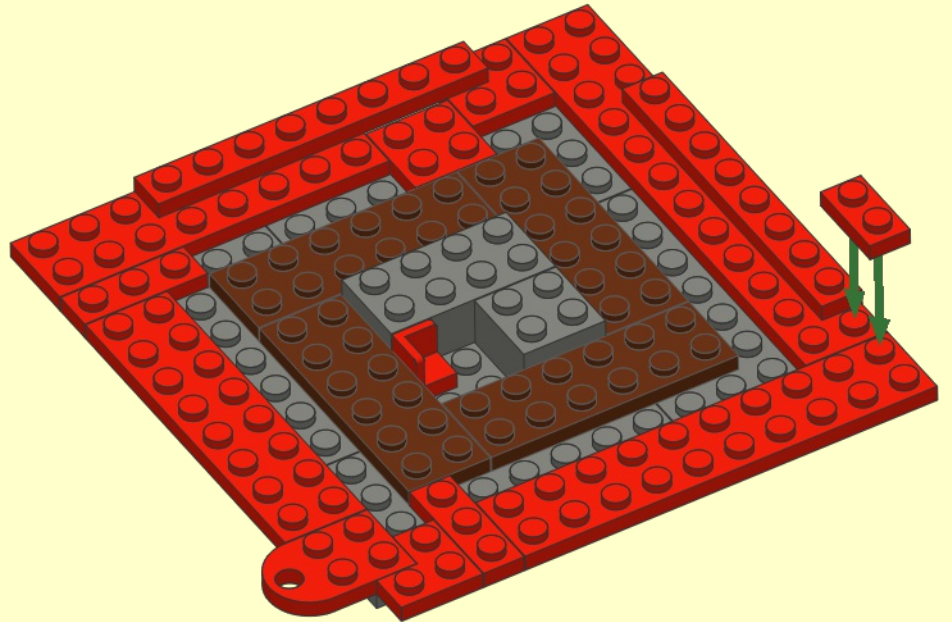
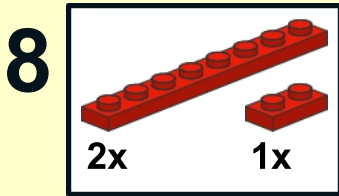
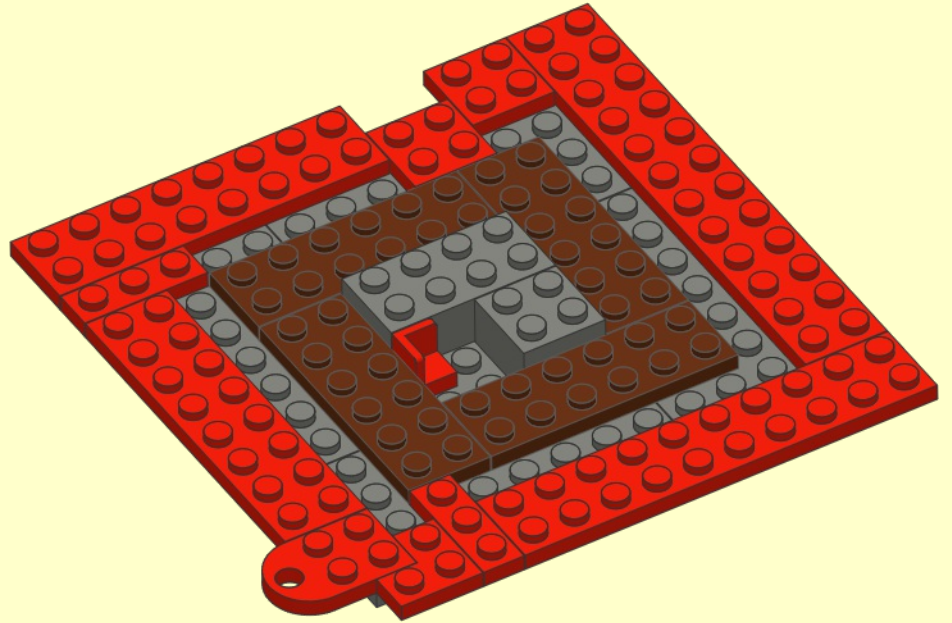
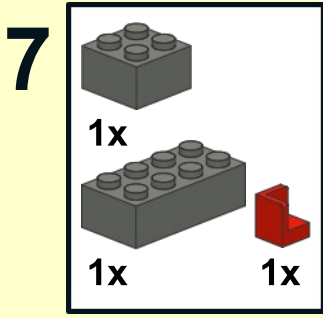



10

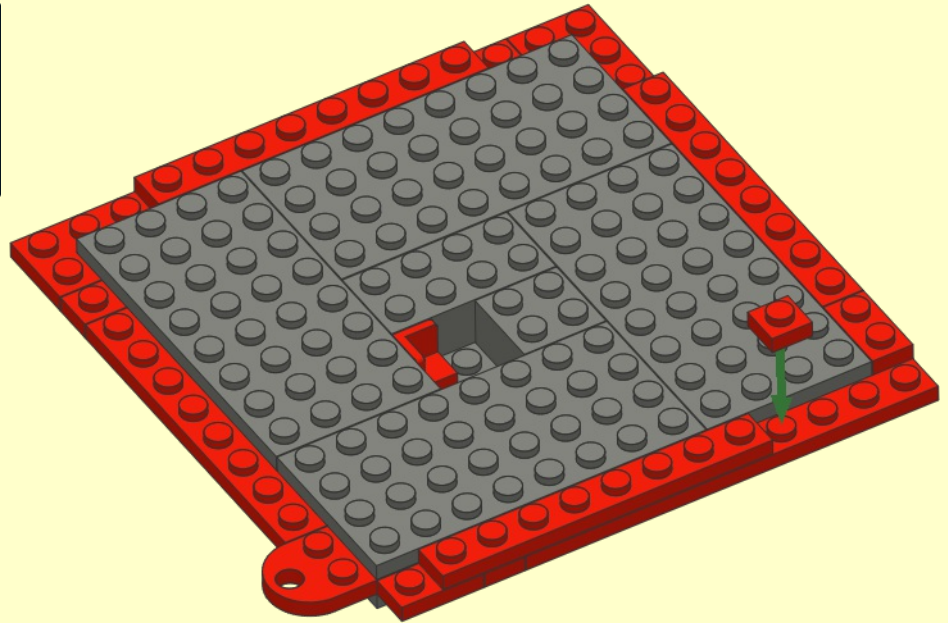
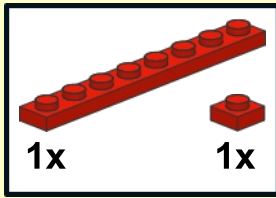

11

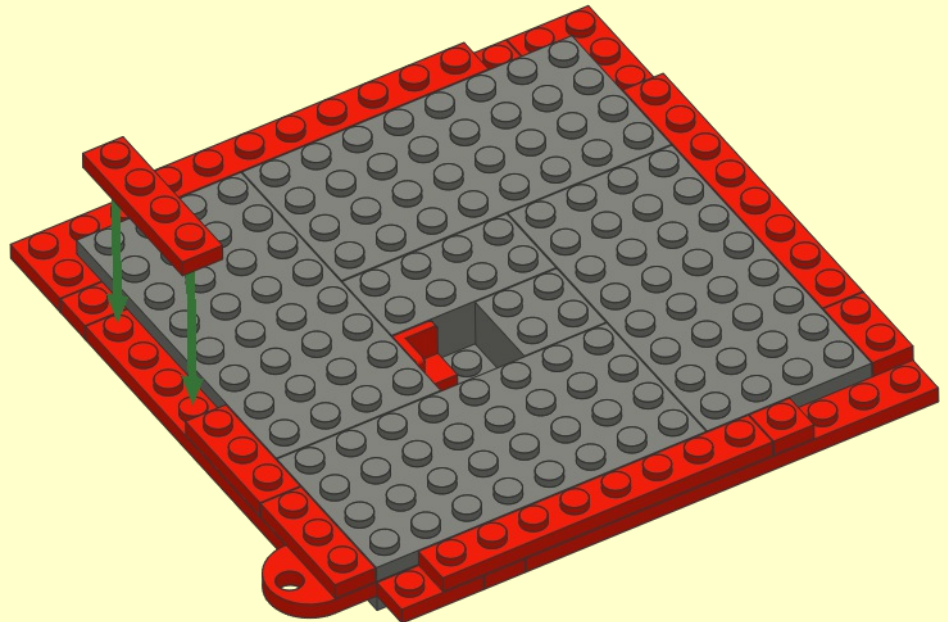
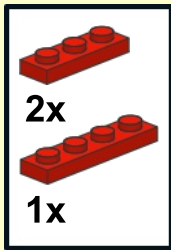

12

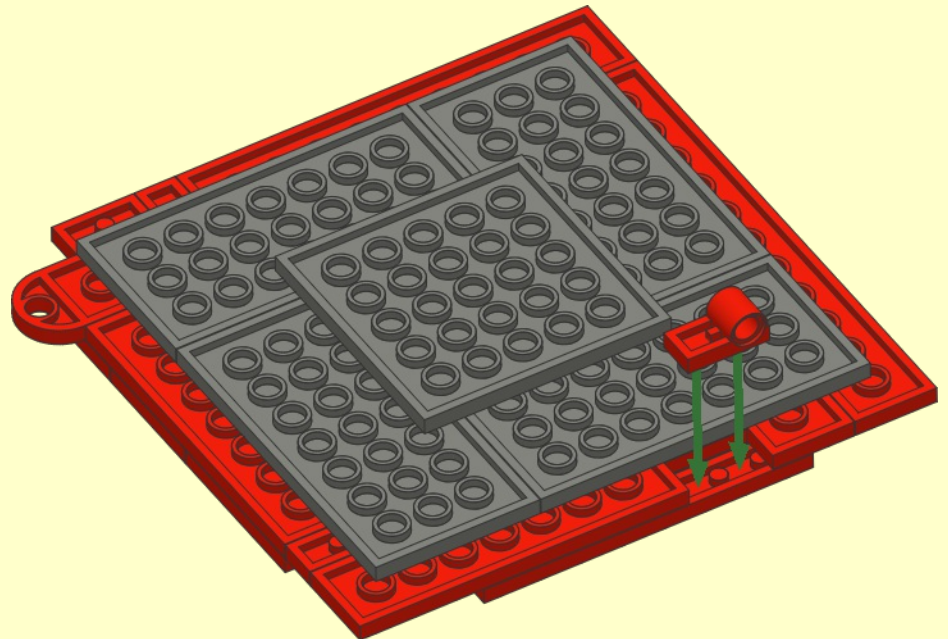

13

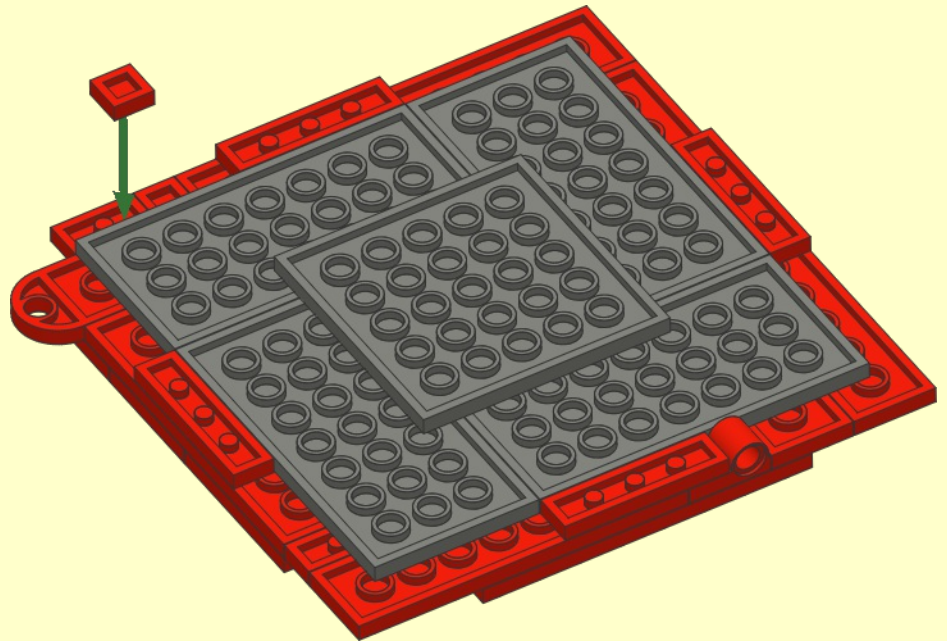
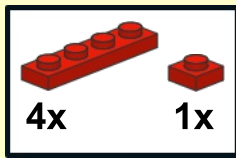

14

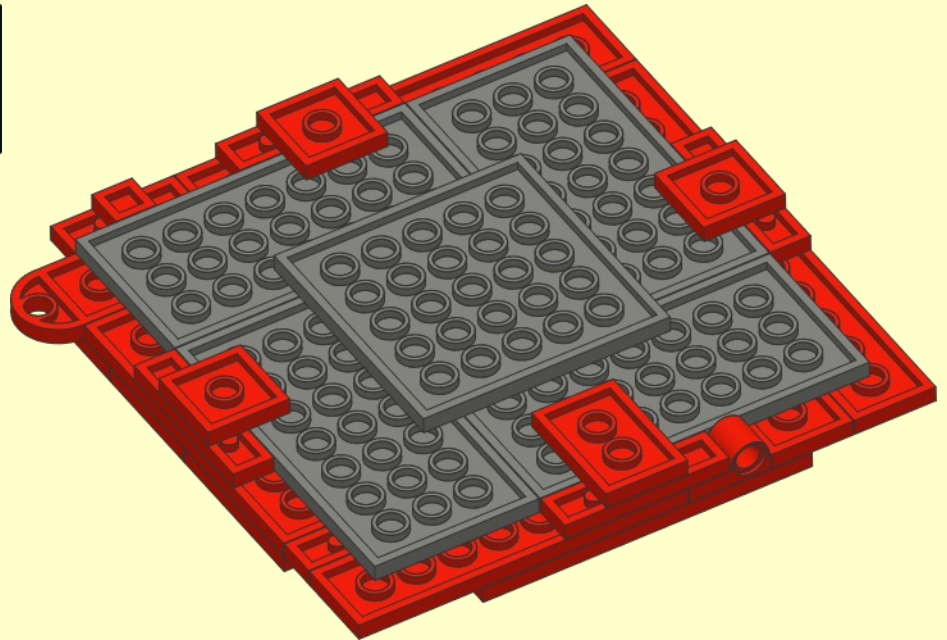
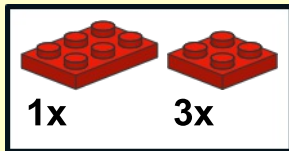

15

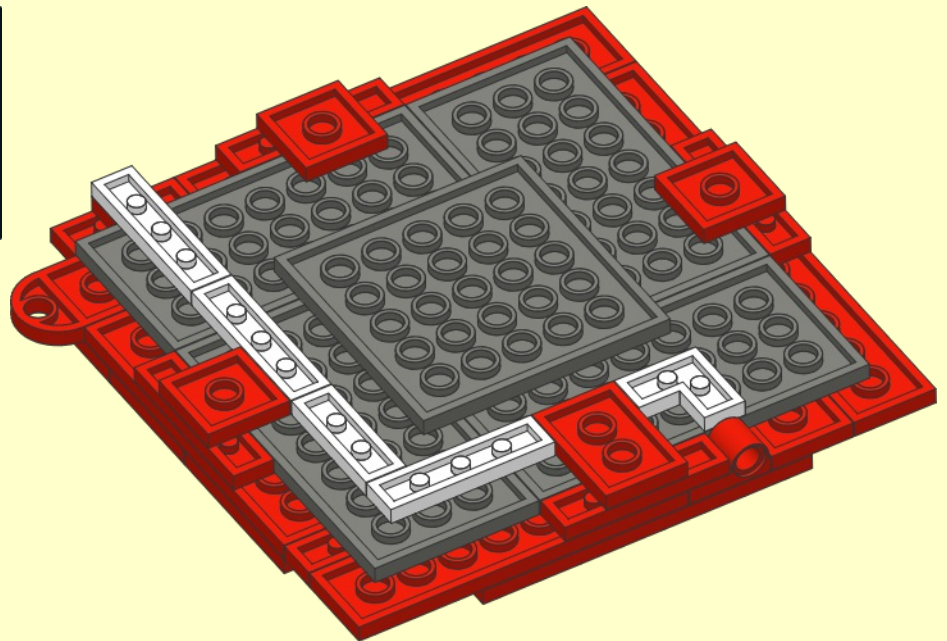
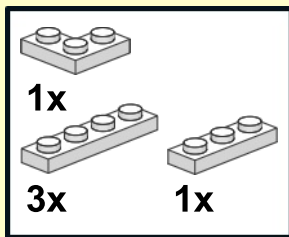

16

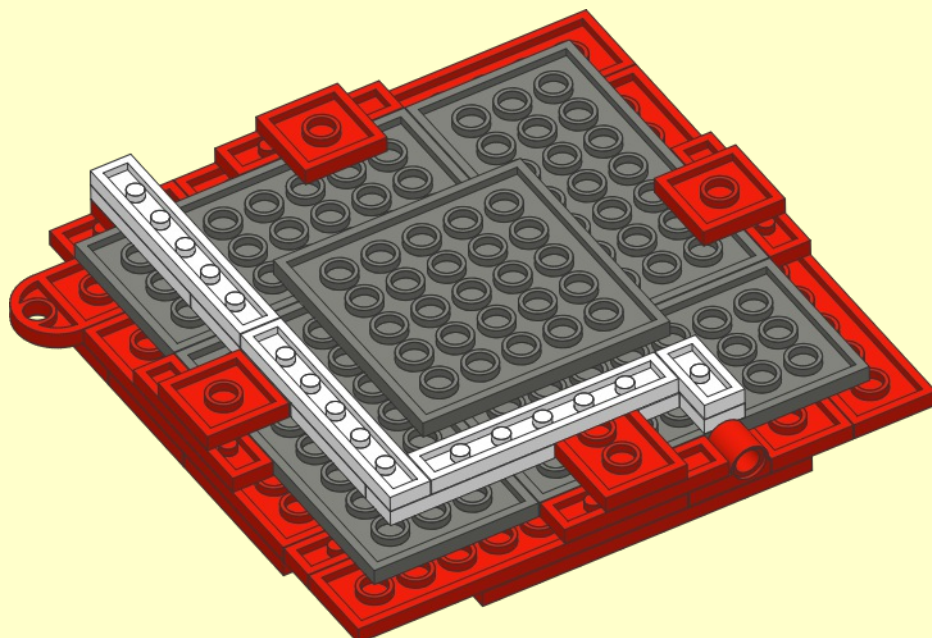
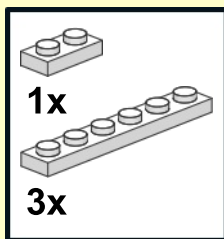

17

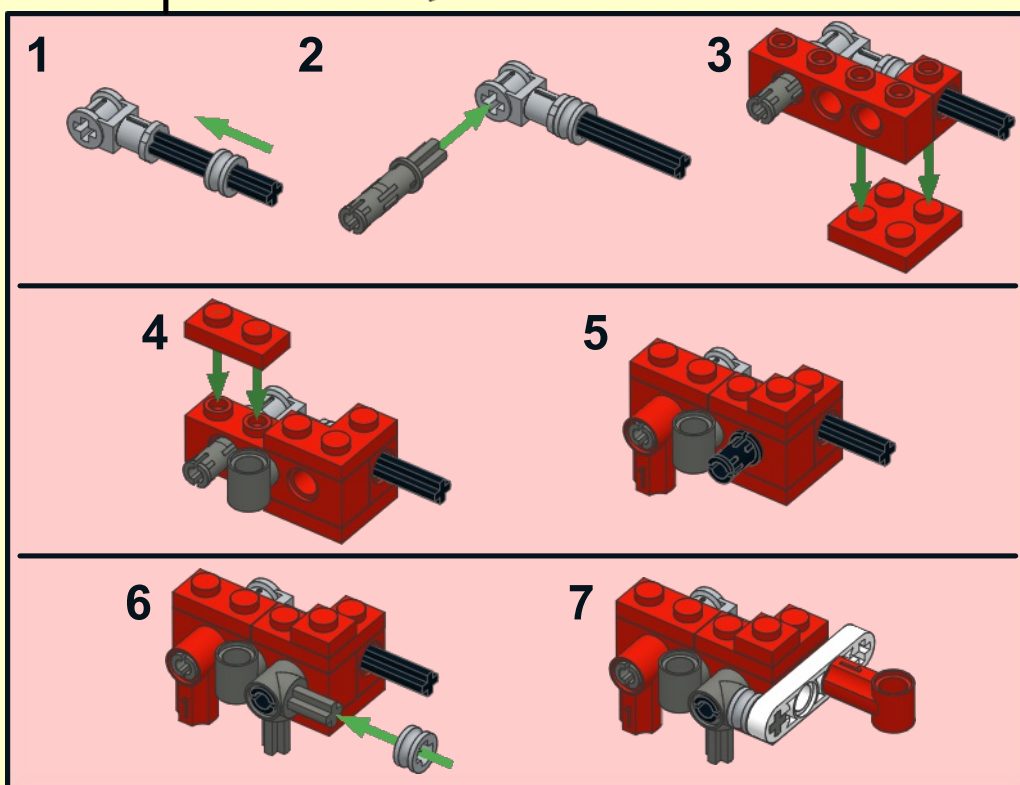
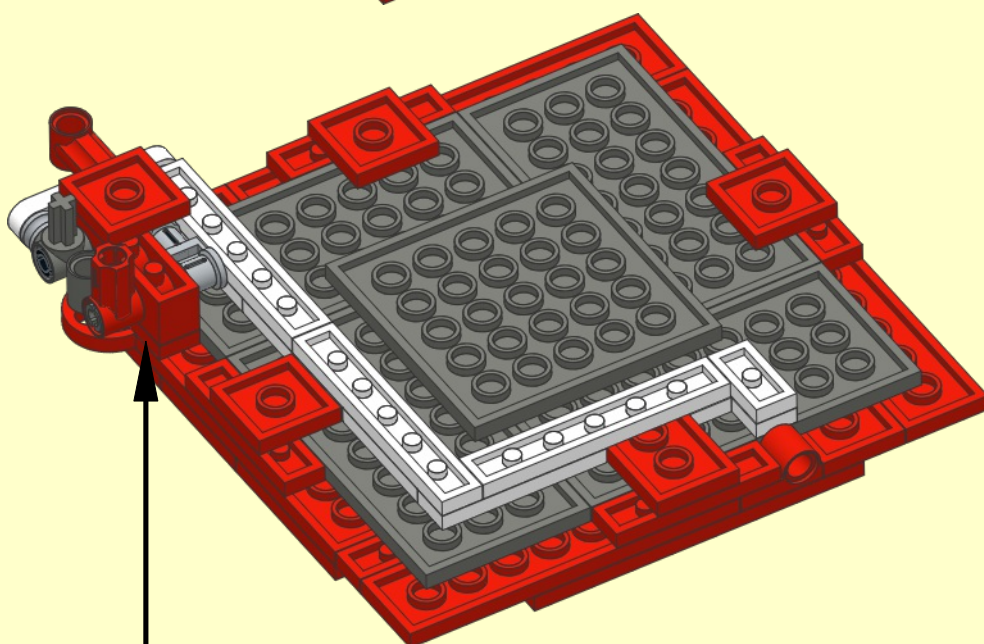
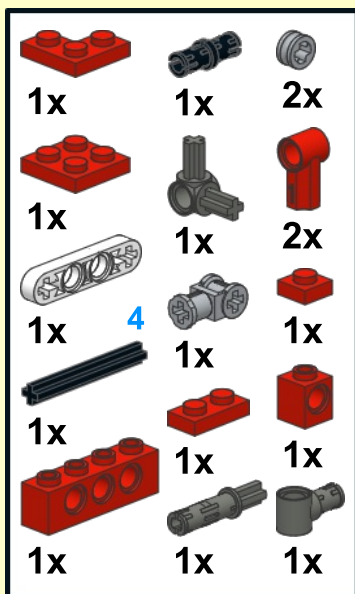

# 18

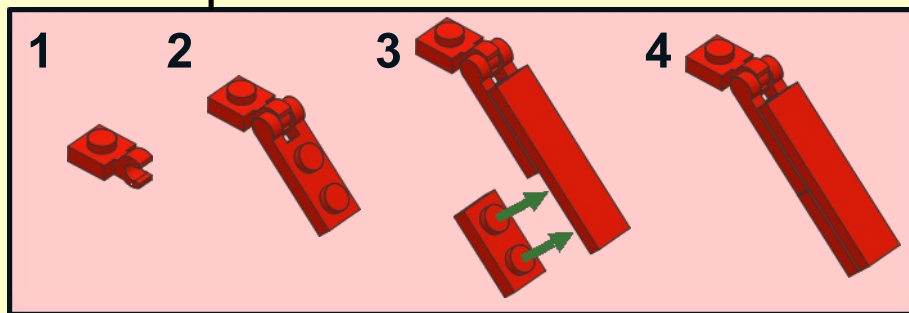
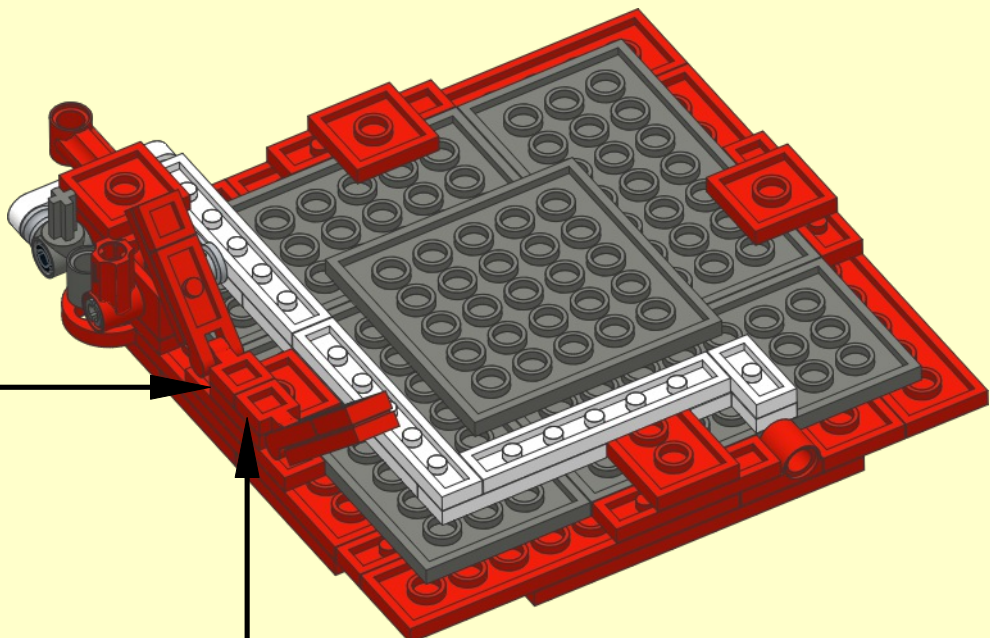
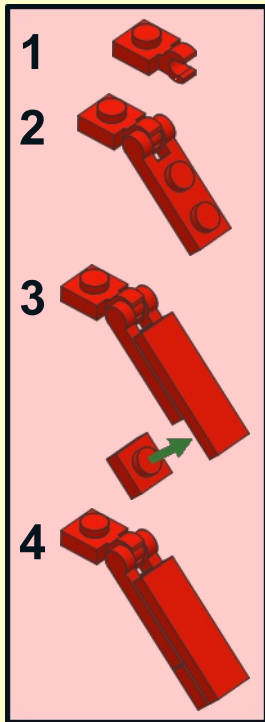
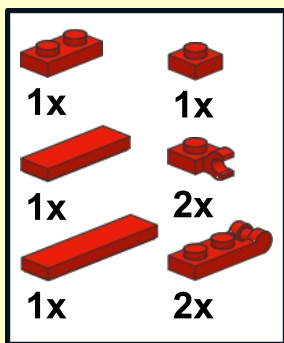

# 19

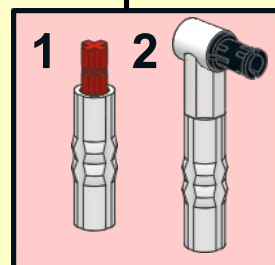
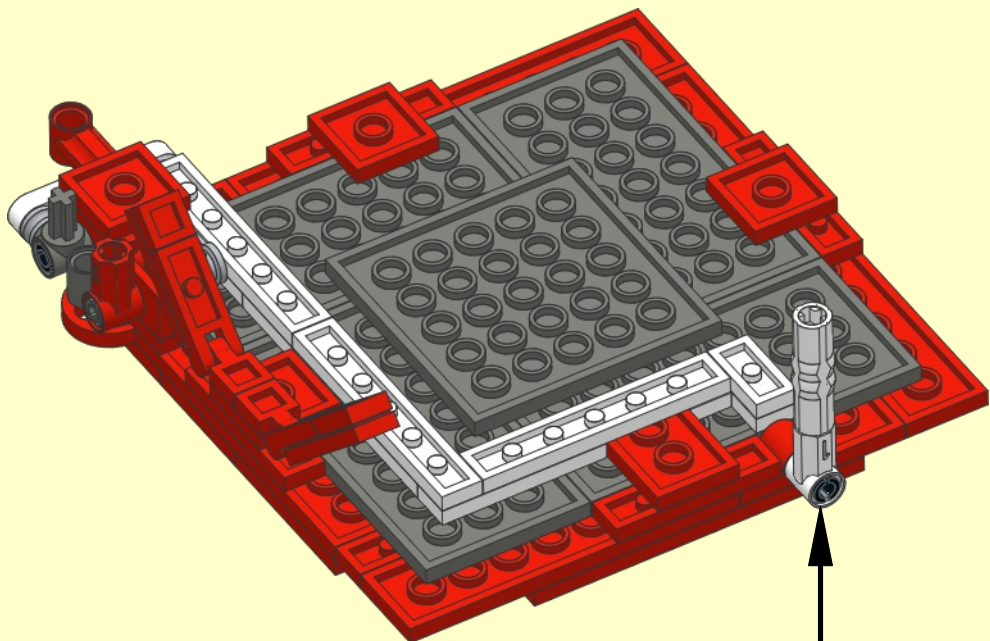
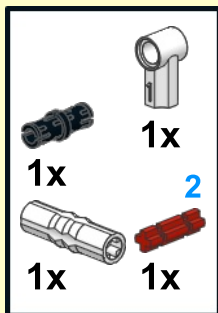

20

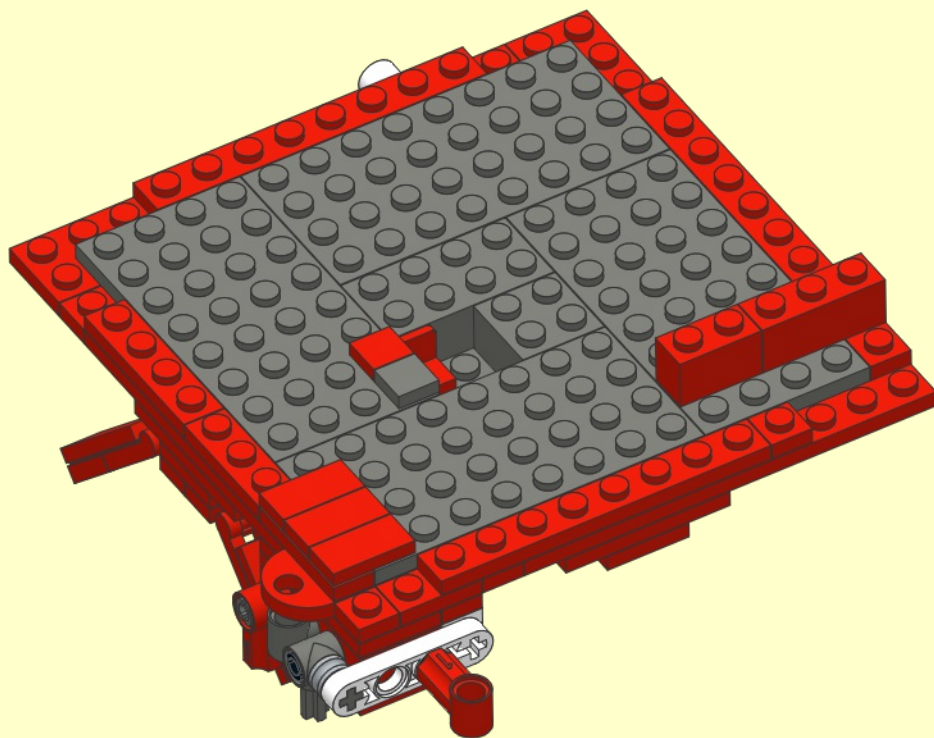
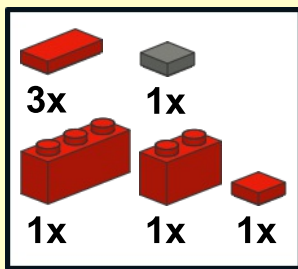

21

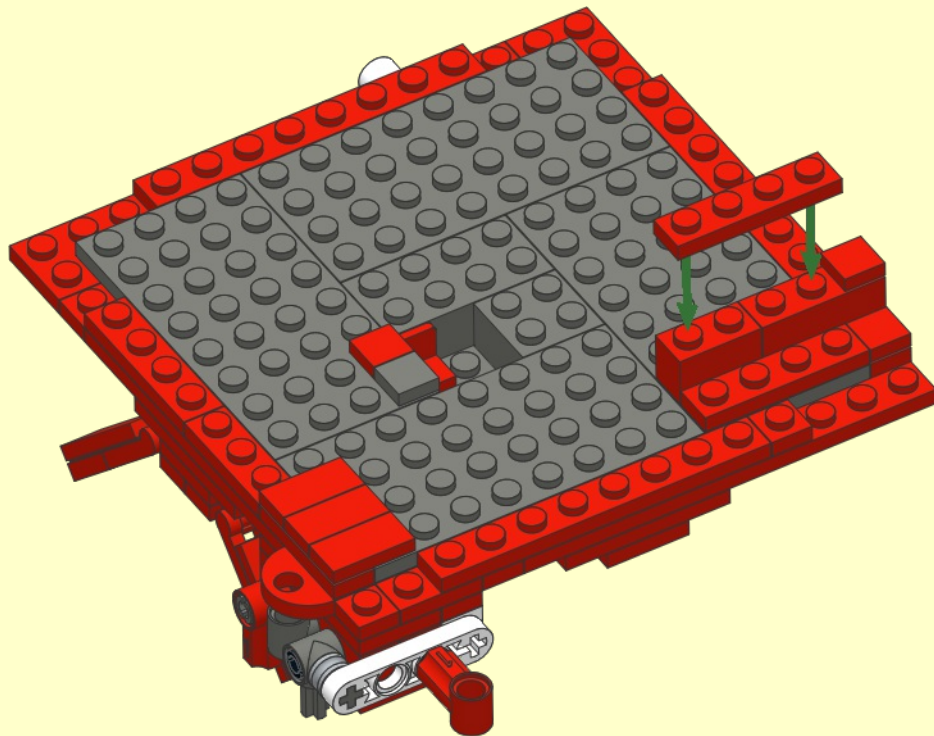
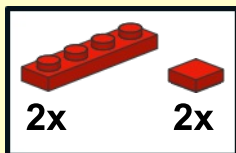

22

- 2x
  - 1x
  - 4x
  - 1x
  - 1x
- 10

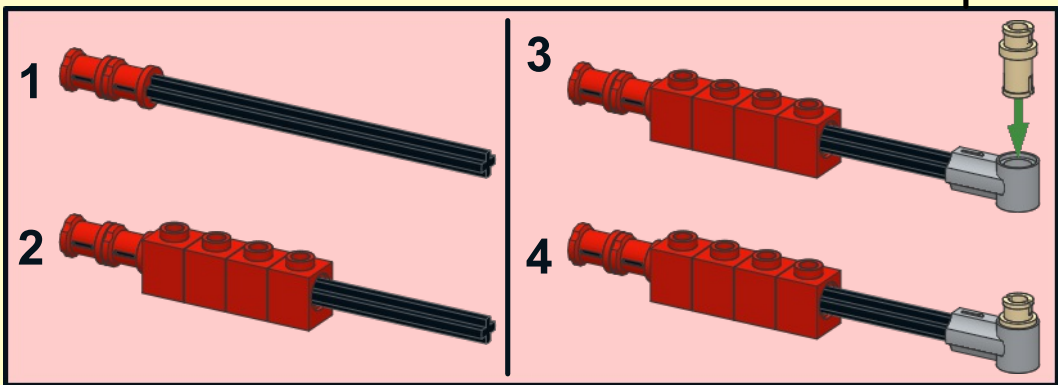
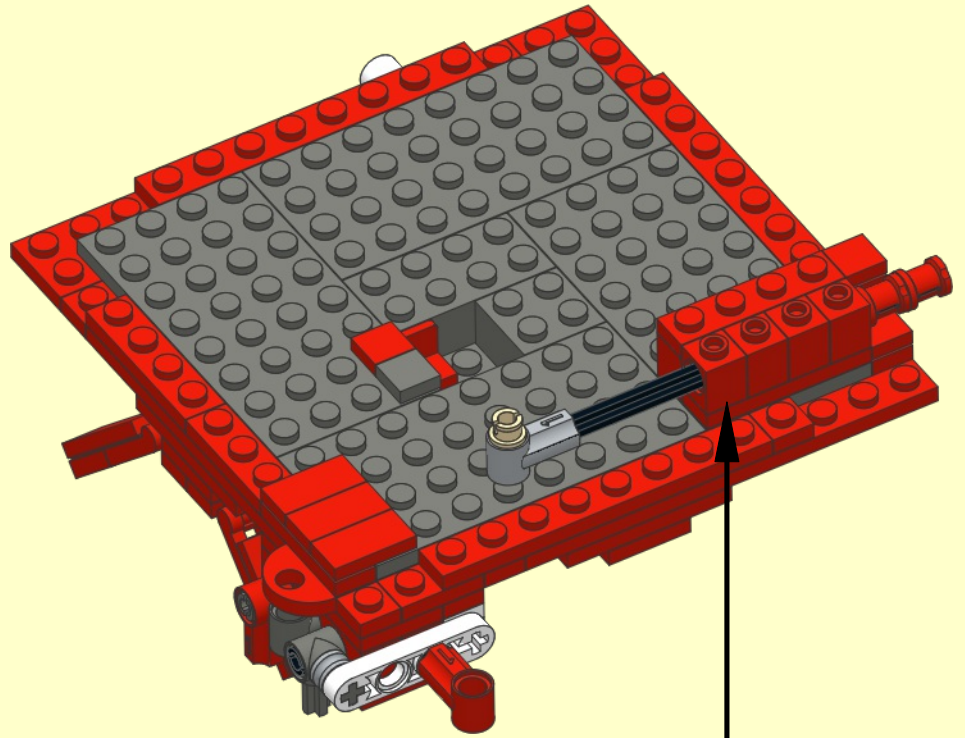

23

- 1x

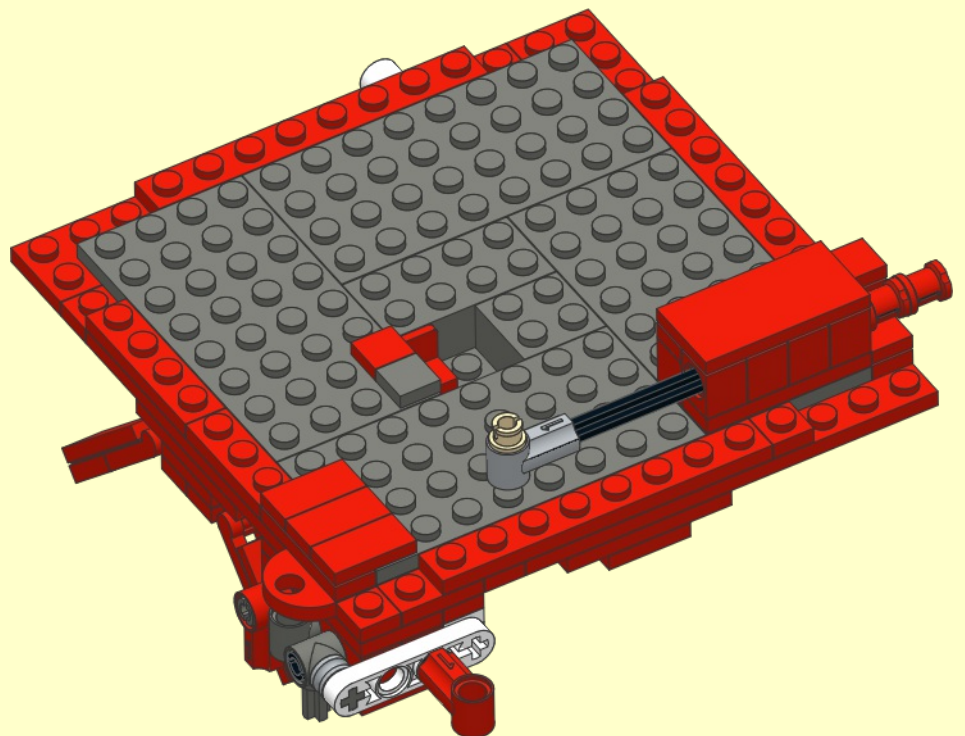

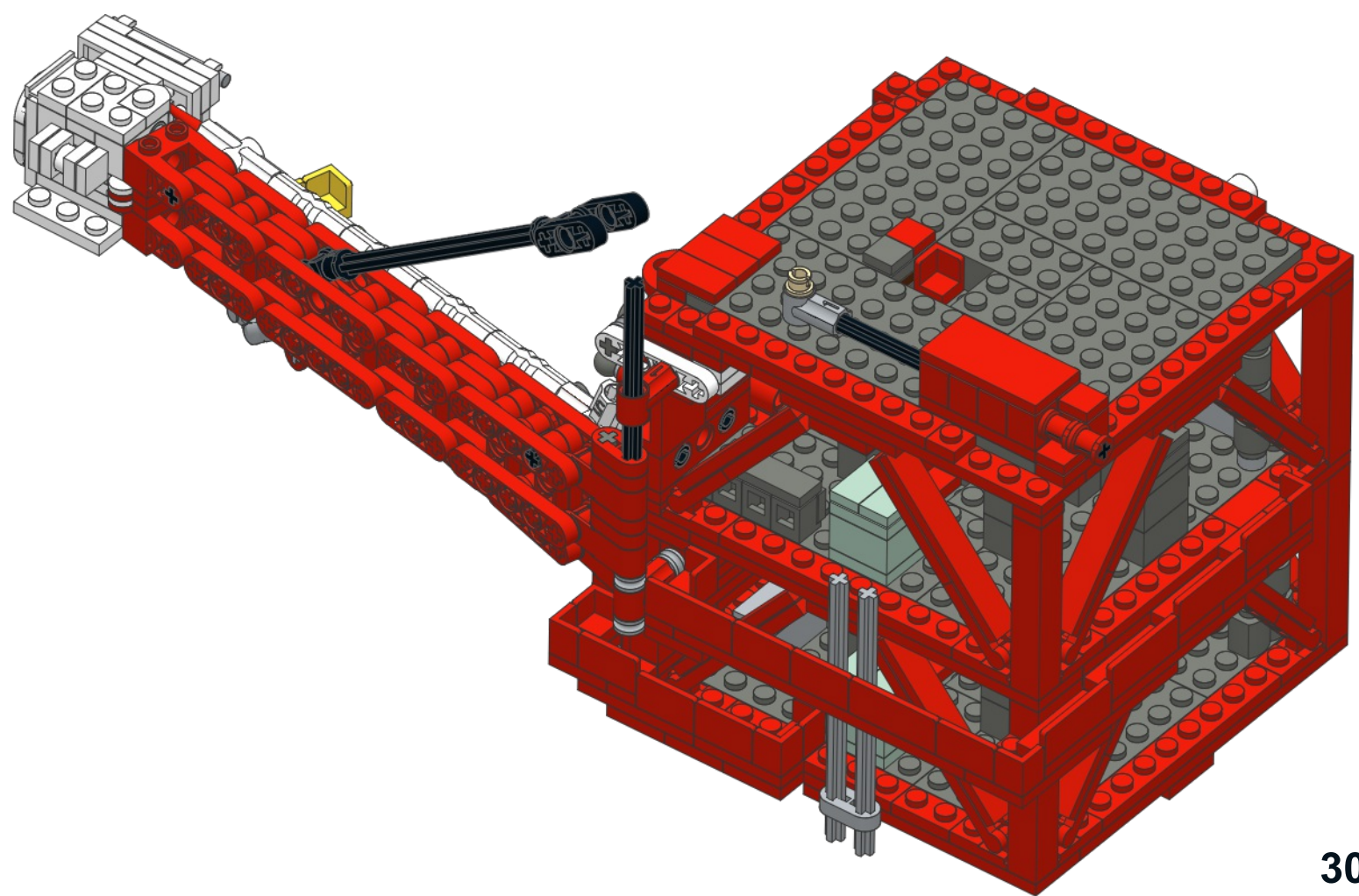

12

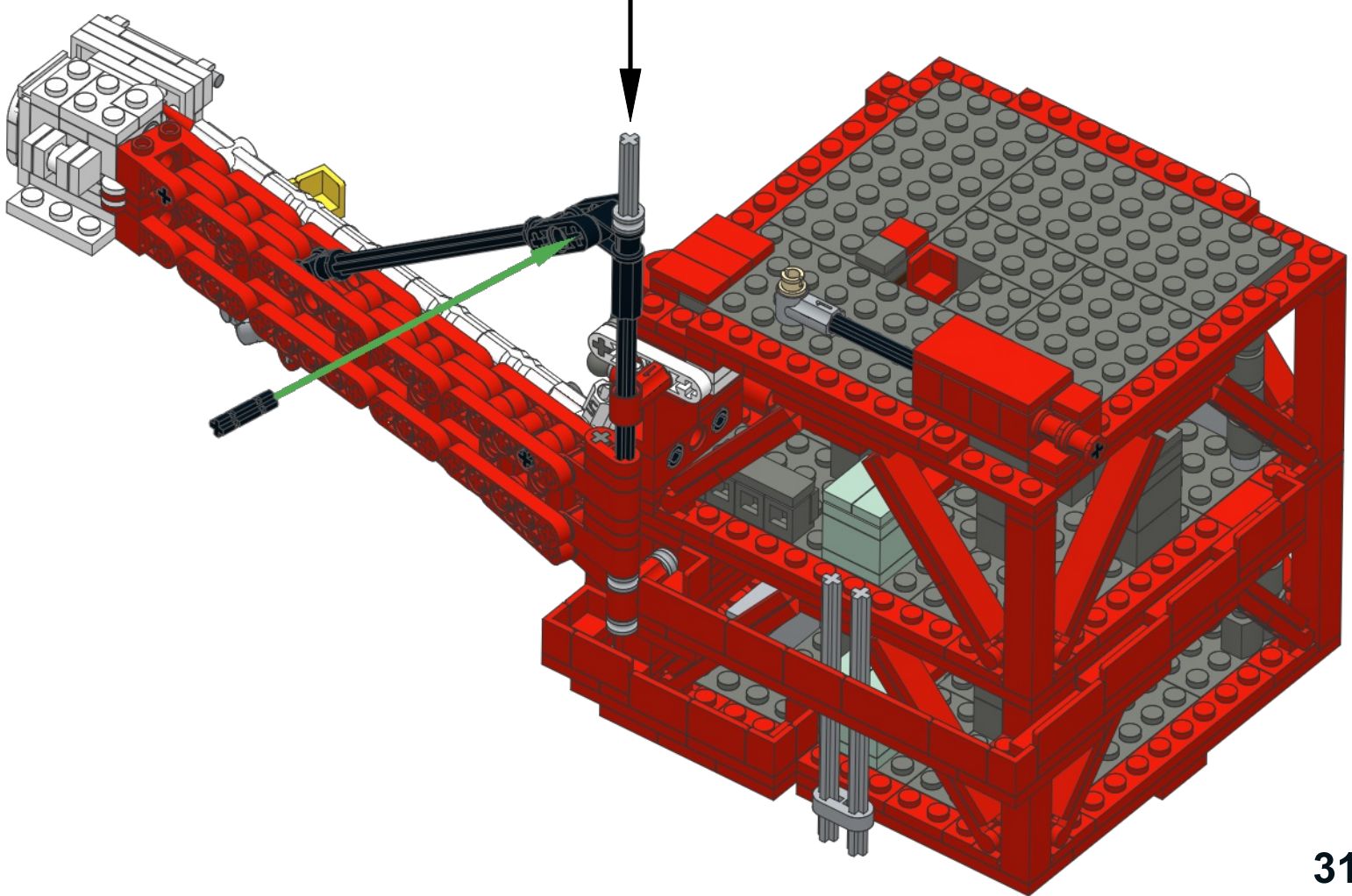
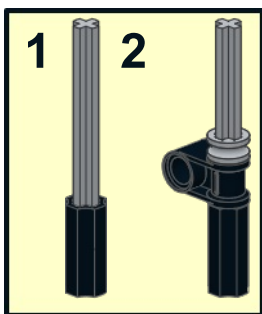
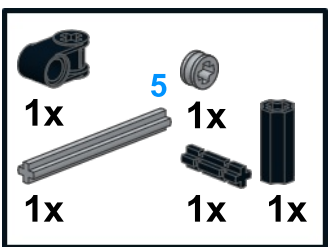



# 13

- |    |    |    |    |    |    |
|----|----|----|----|----|----|
|    |    |    |    |    |    |
| 2x | 2x | 3  | 2  | 2x |    |
|    |    |    |    |    |    |
| 1x | 1x | 1x | 1x | 1x | 1x |
|    |    |    |    |    |    |
| 2x | 1x | 1x | 1x | 1x | 1x |

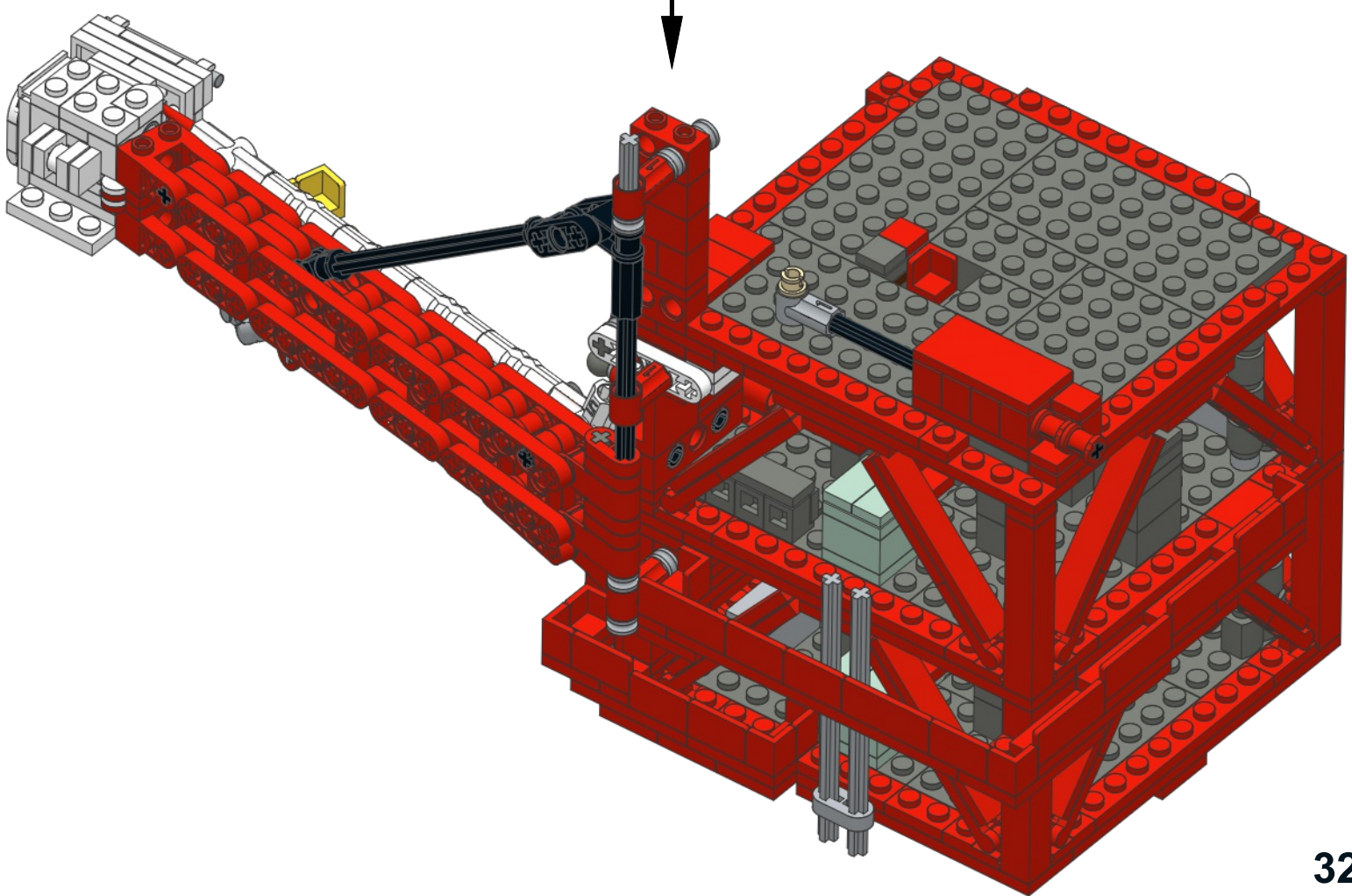
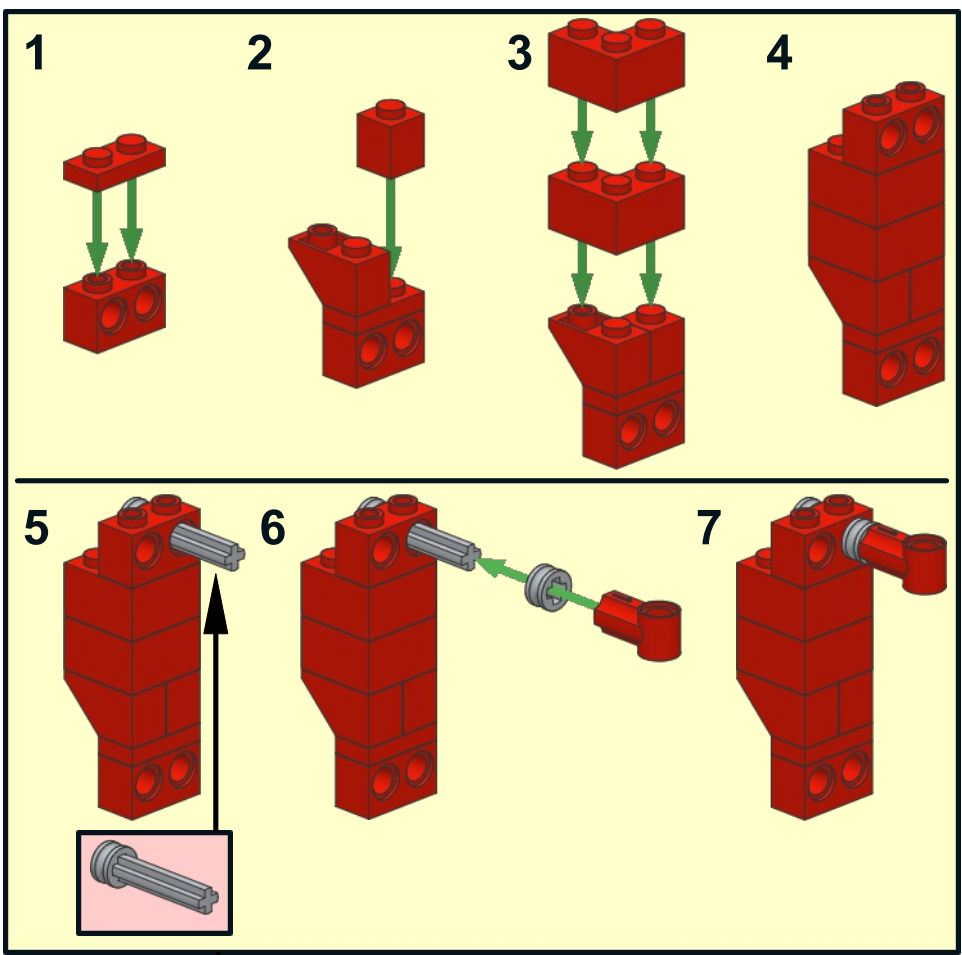

14

- 2x
- 2x
- 2x
- 2x
- 2x
- 2x
- 2x
- 1x
- 1x
- 1x
- 1x
- 1x
- 1x
- 2x

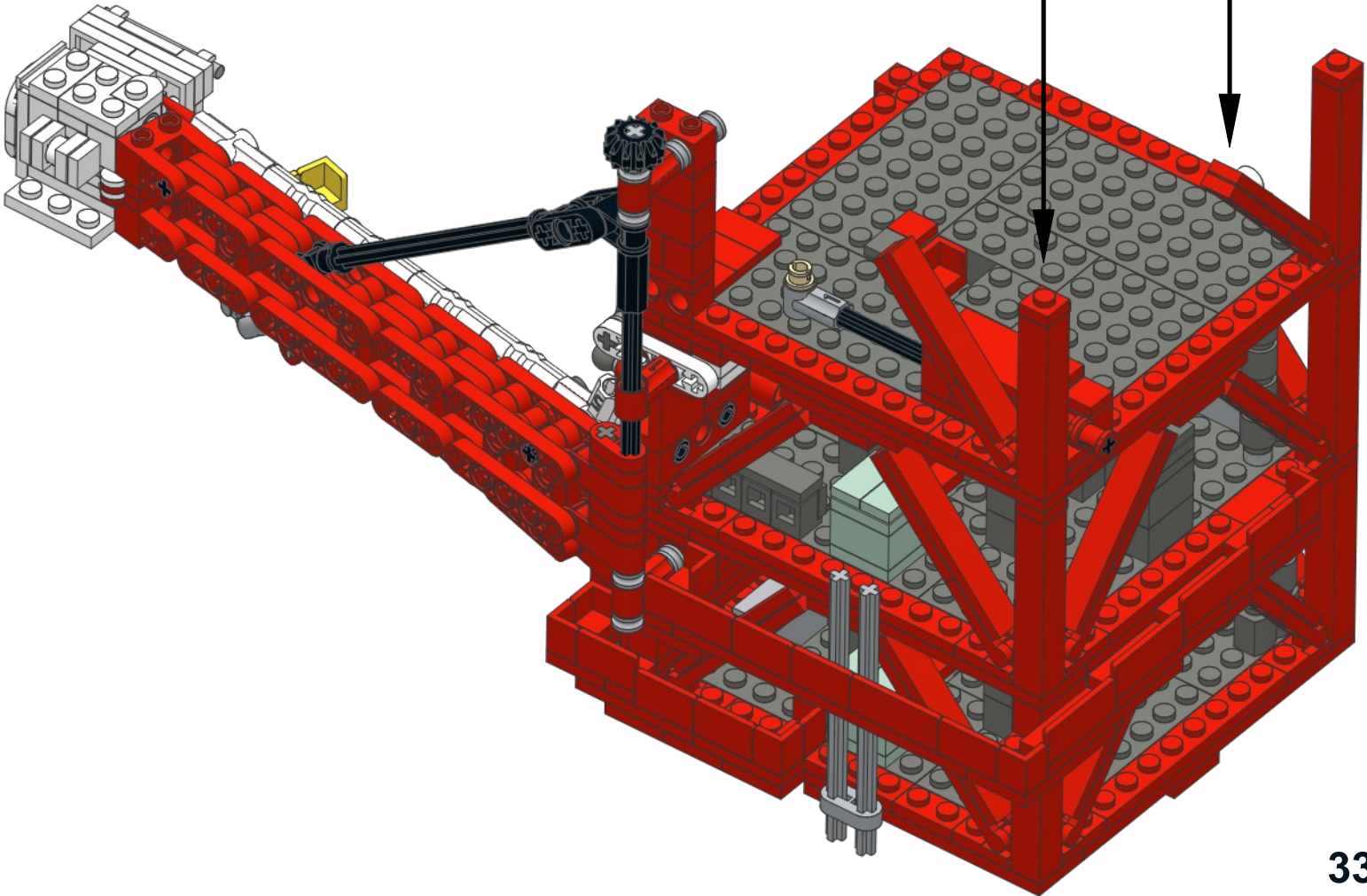

# 15

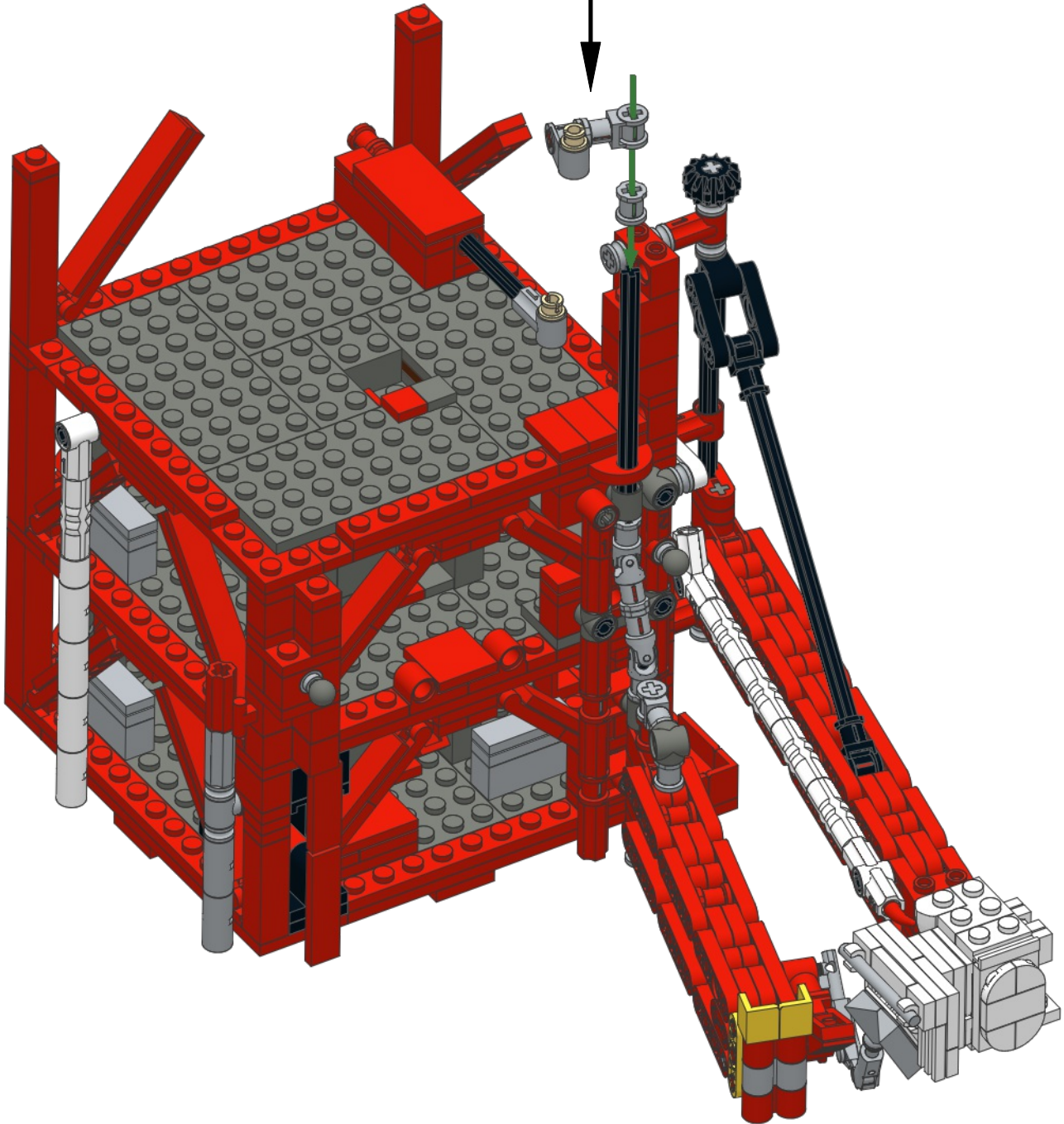
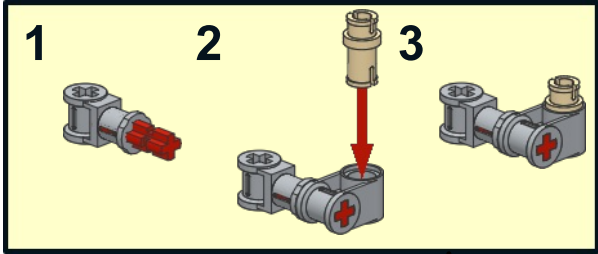
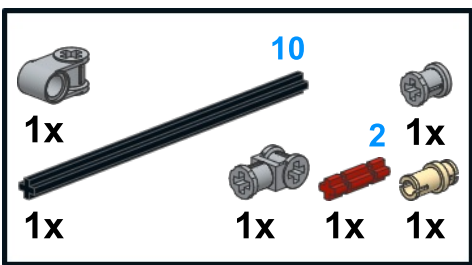



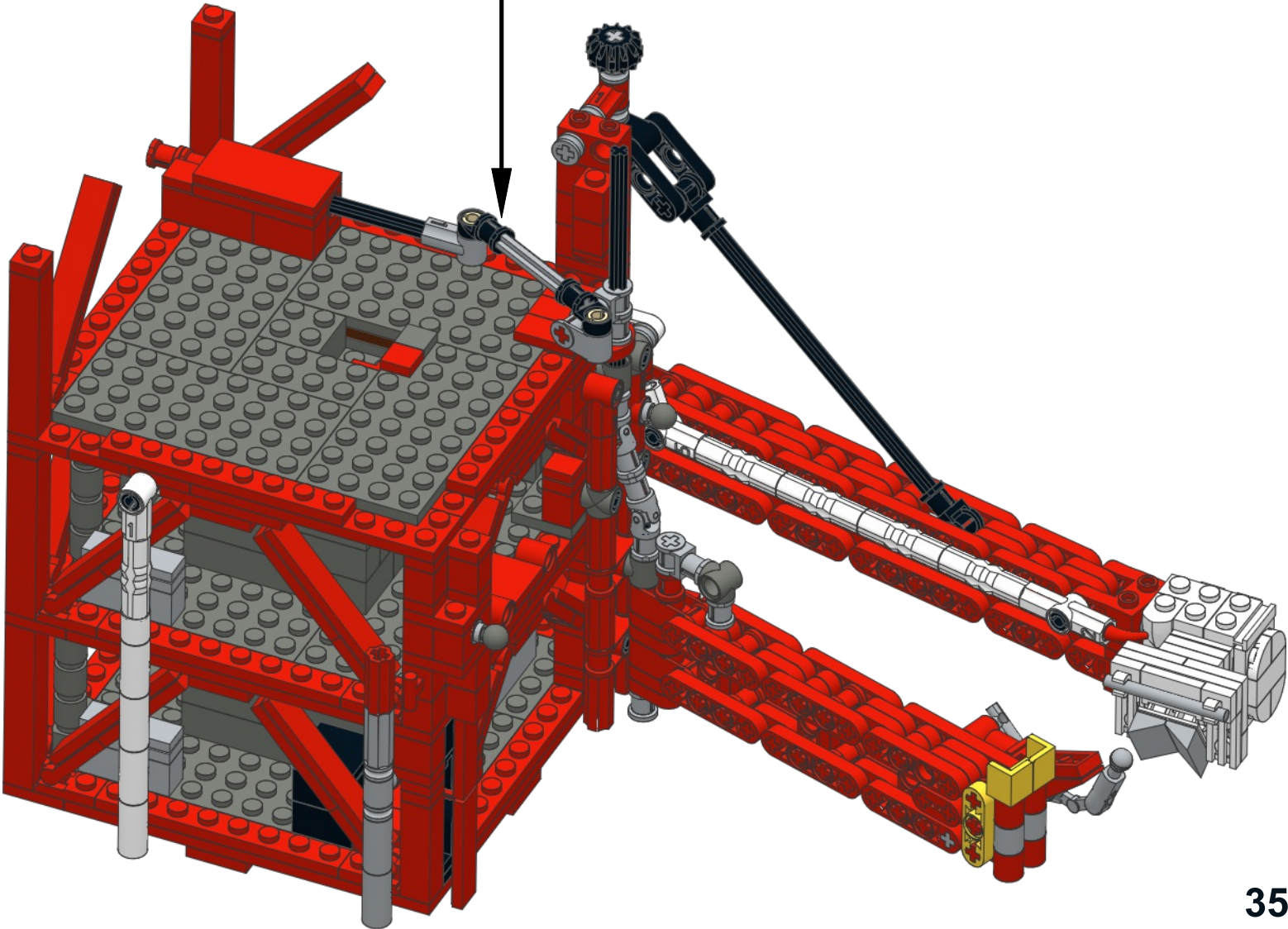
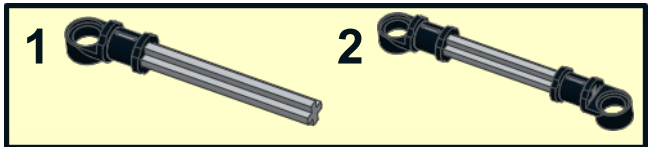



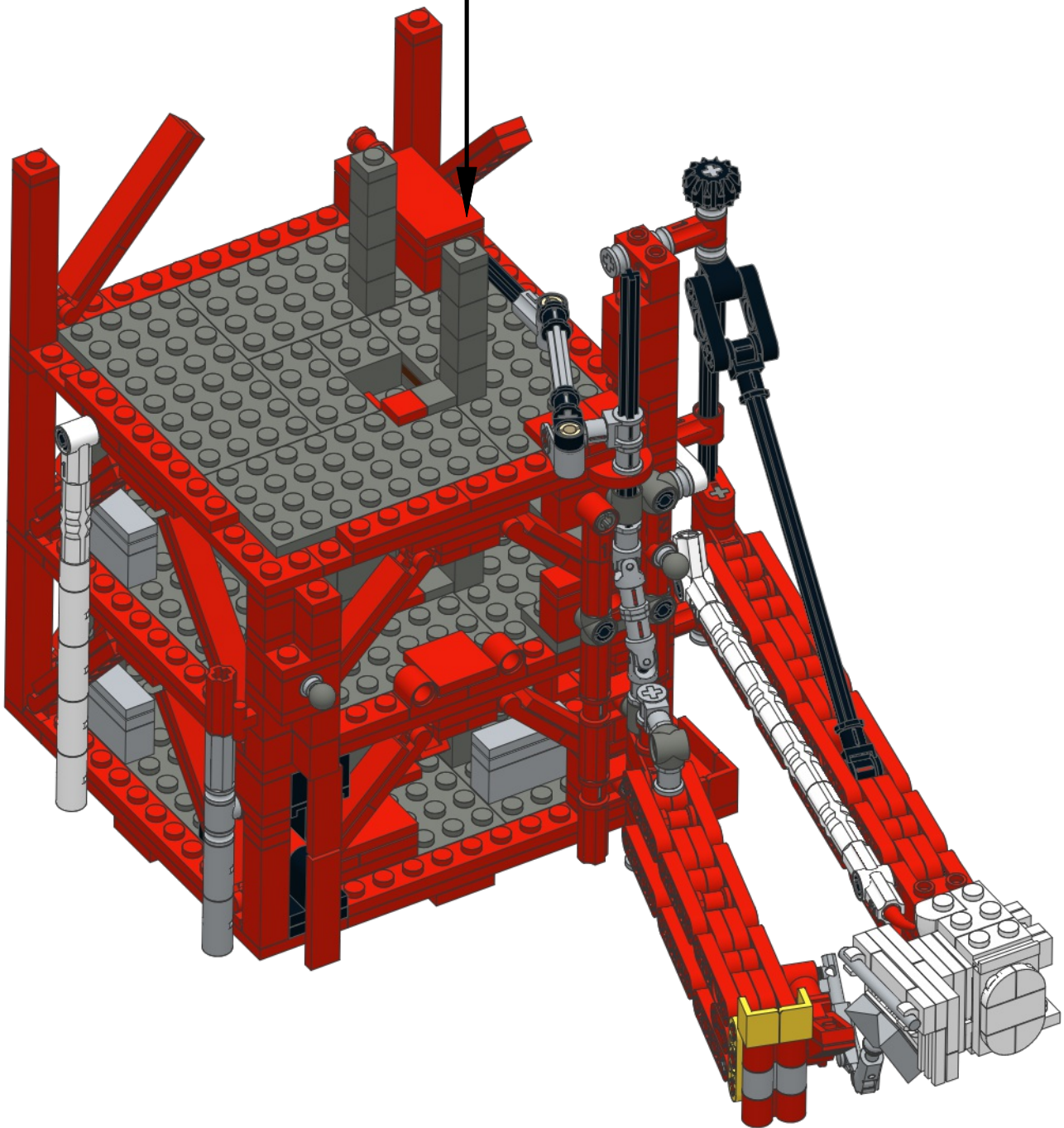
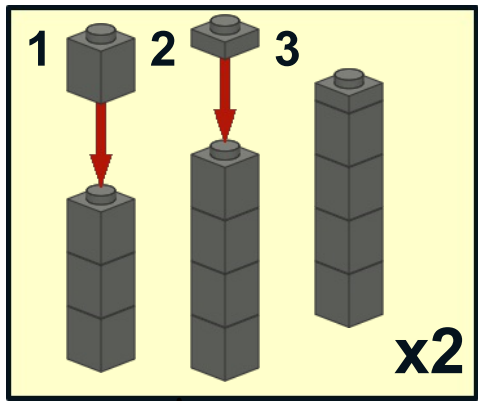
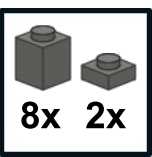

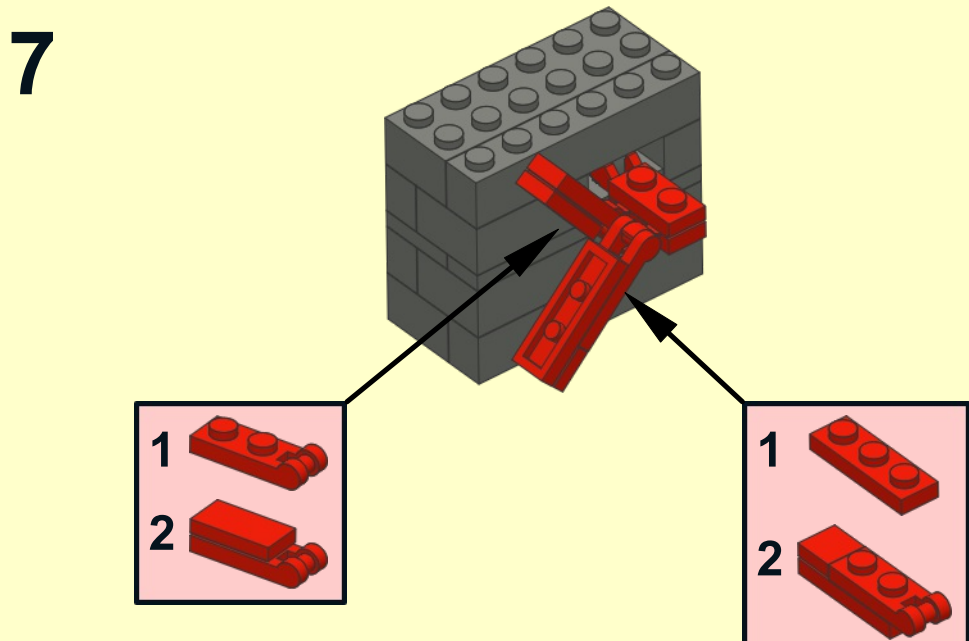
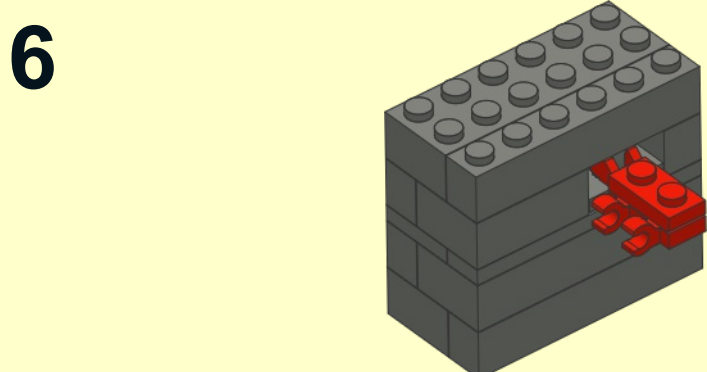
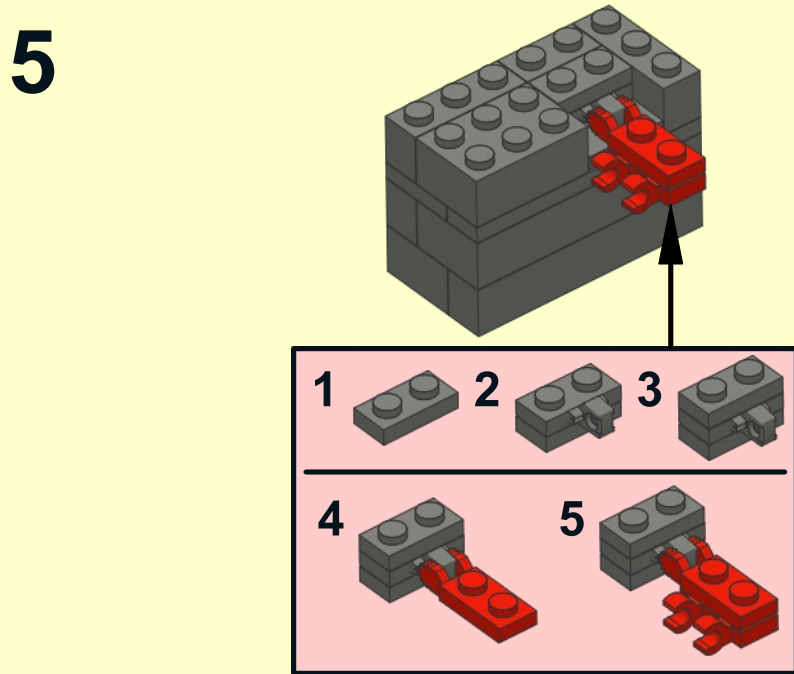
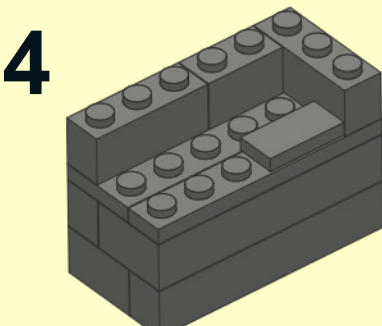
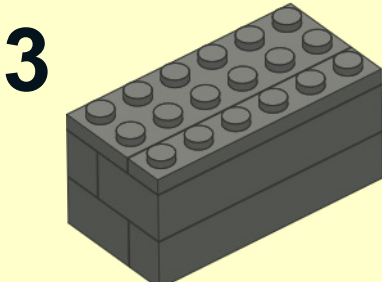
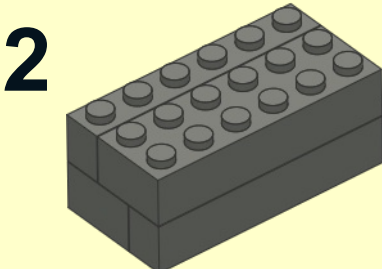
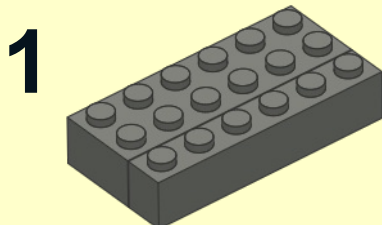
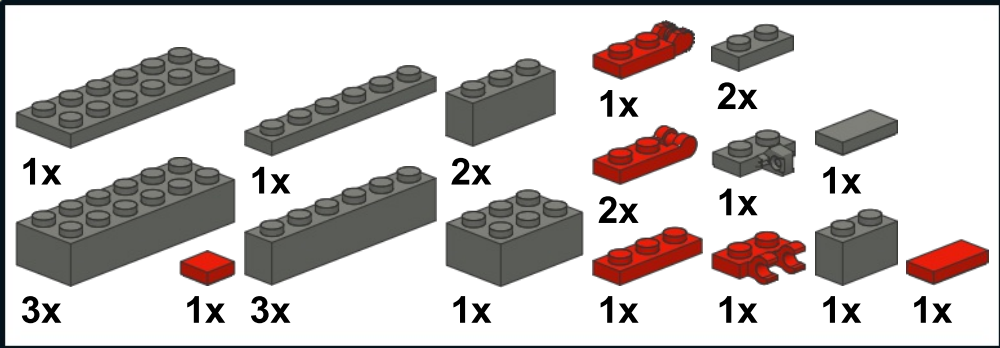
16

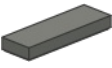



17



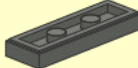
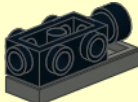
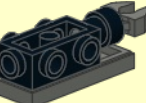
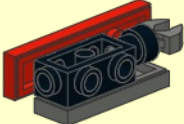
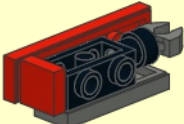

- 1x 
- 1x 
- 1x 
- 1x 
- 1x 
- 1x 
- 1x 
- 1x 

- 1 
- 2 
- 3 
- 4 
- 5 
- 6 

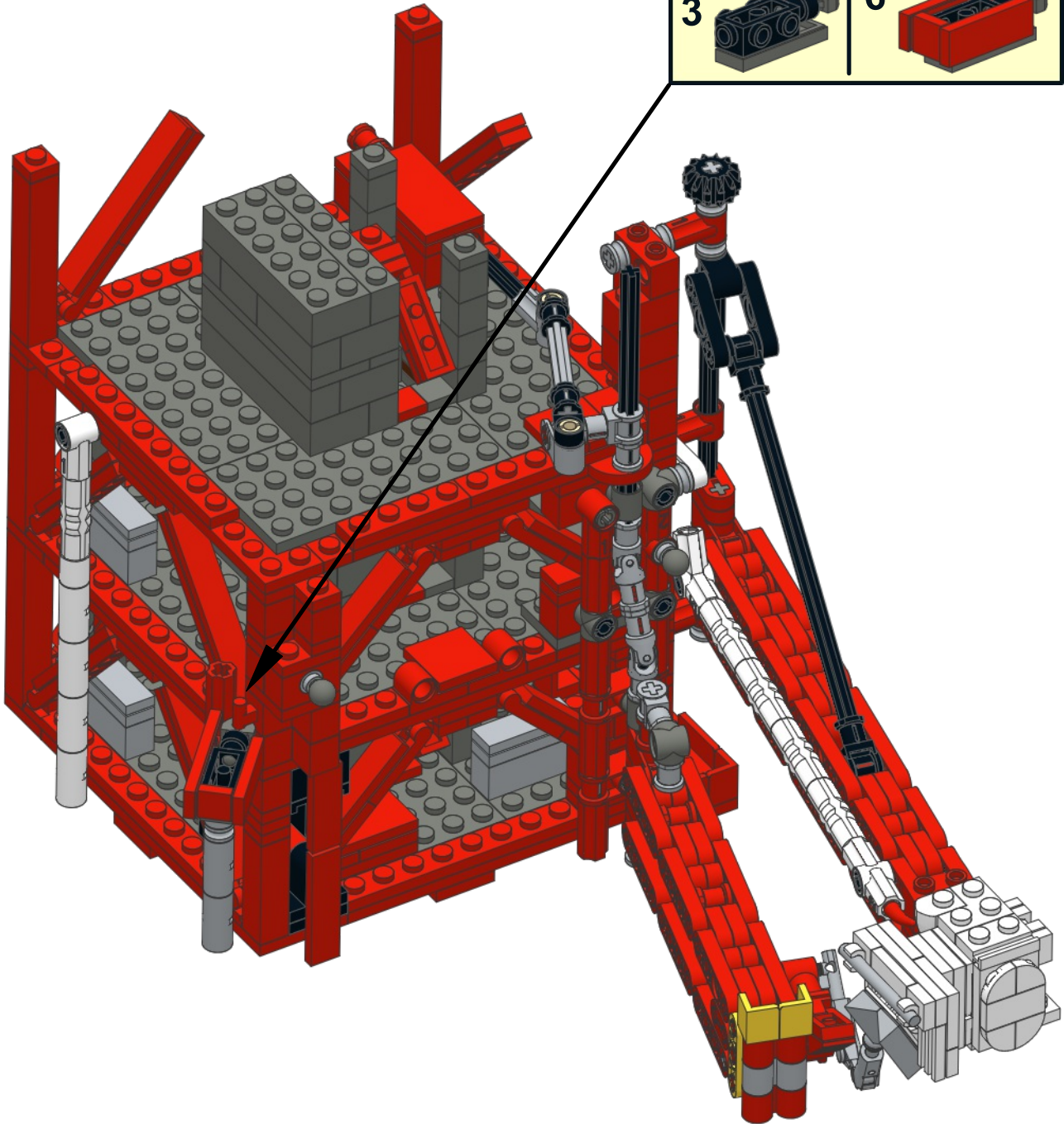

# 19

- 3x
- 3x
- 3x
- 1x
- 3x
- 1x

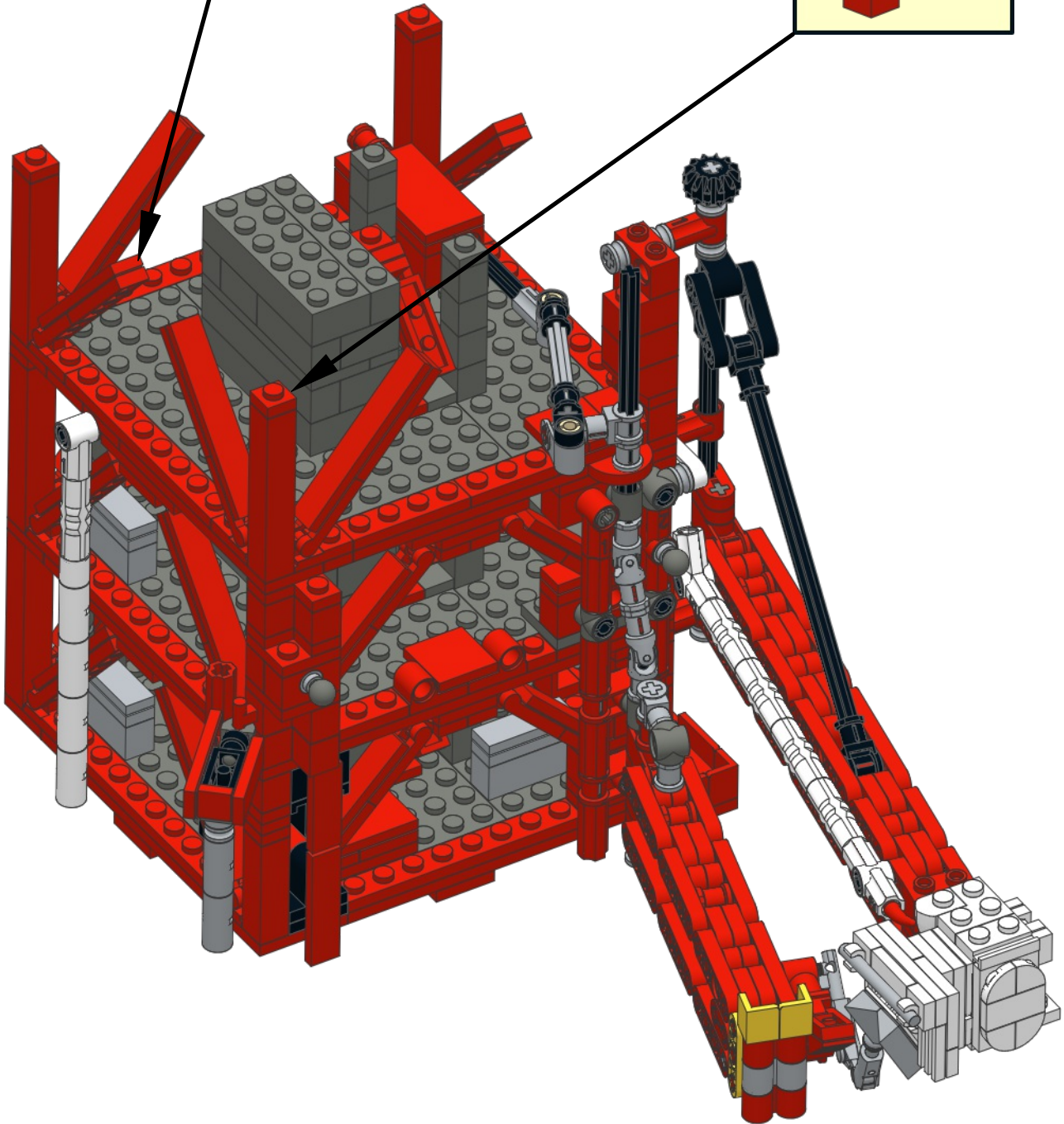
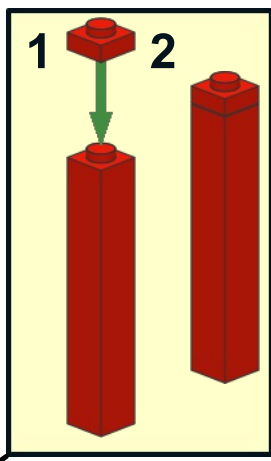
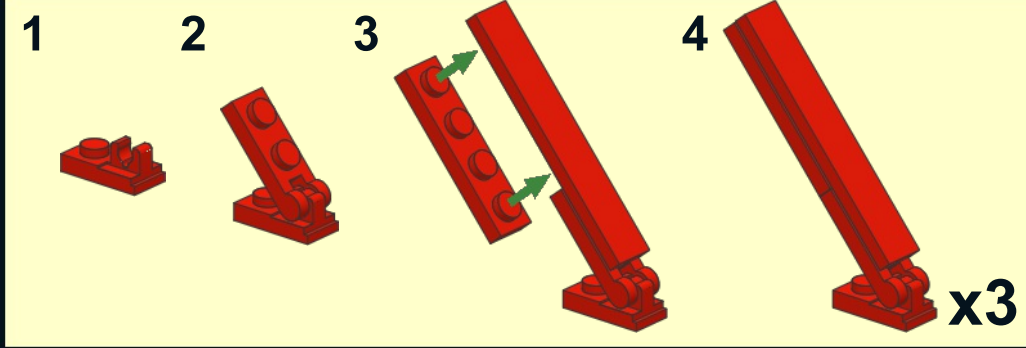



1

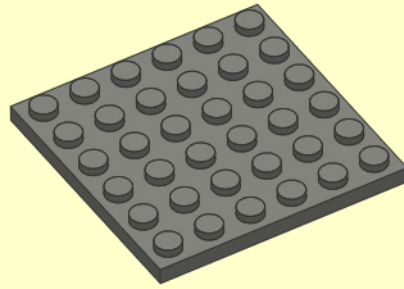
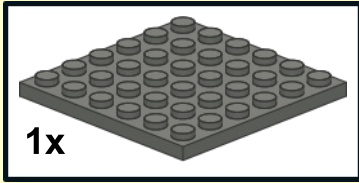

2

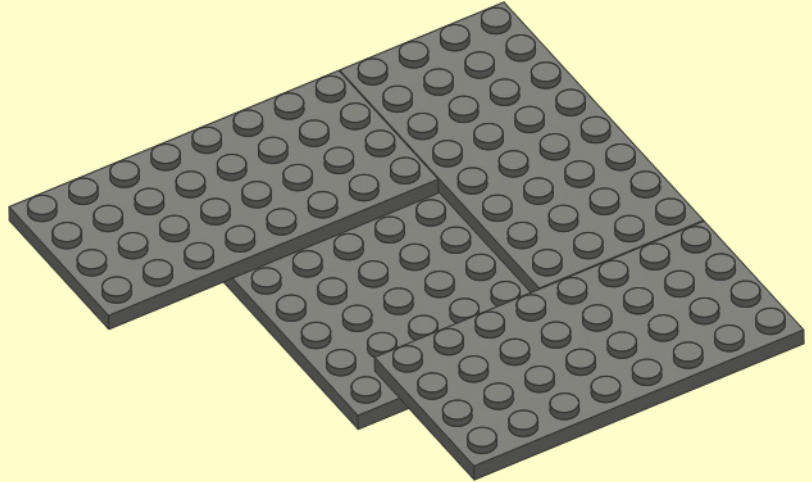
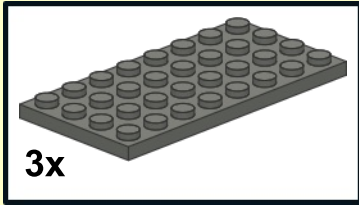

3

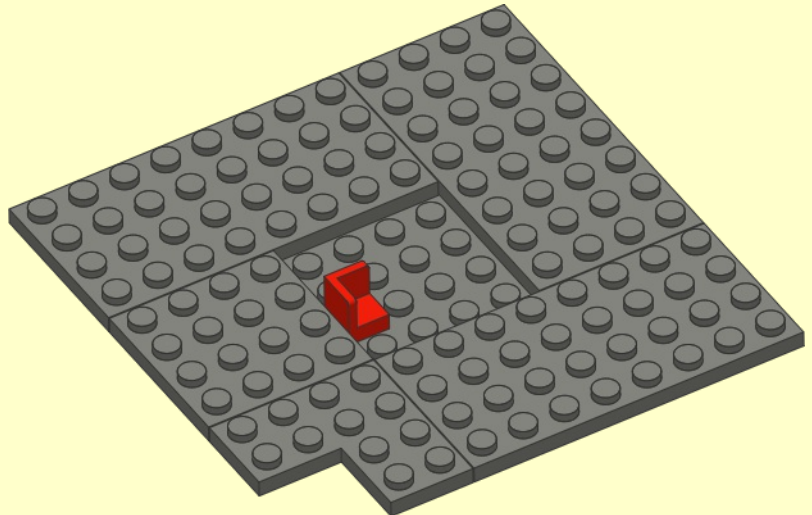
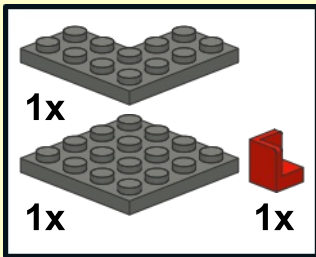

4

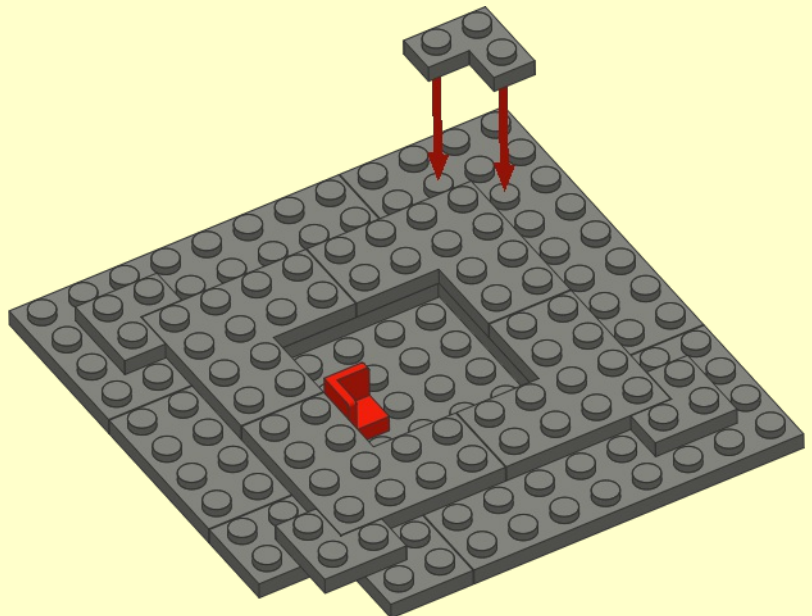
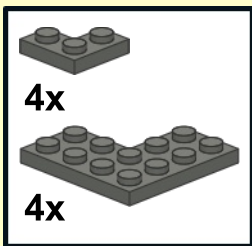

5

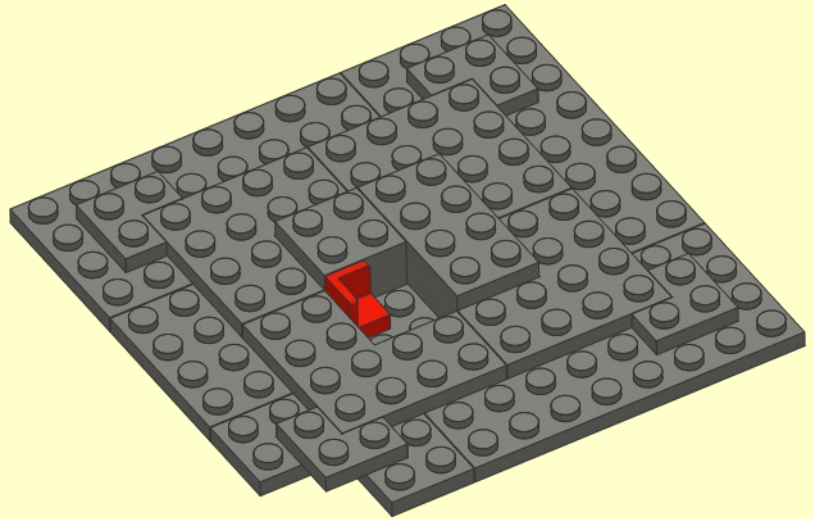
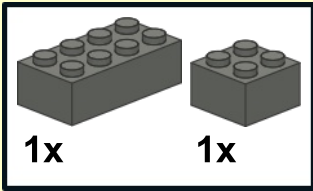

6

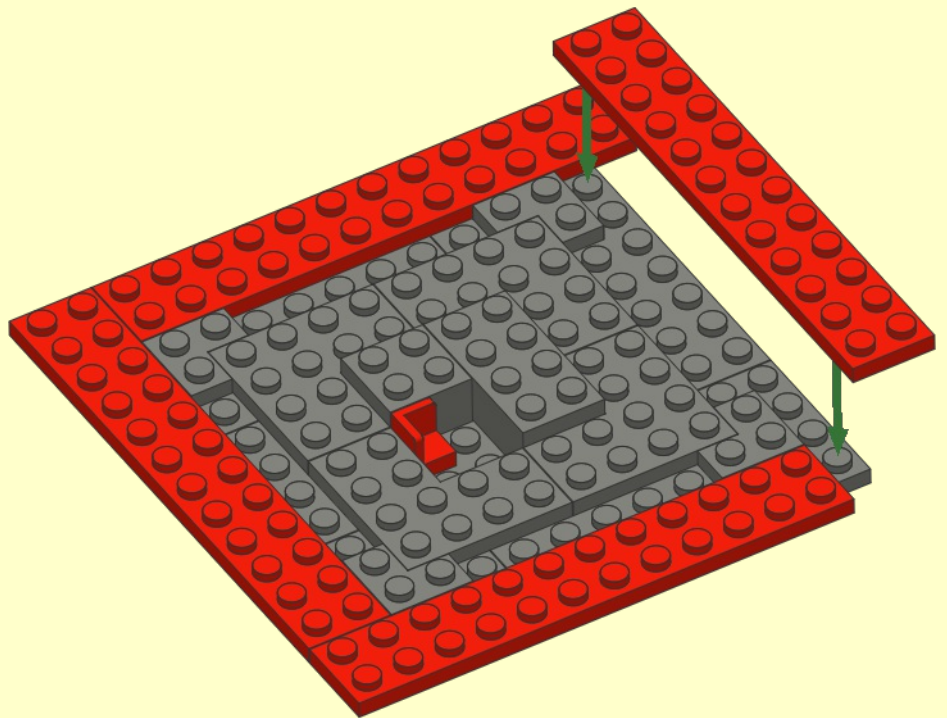
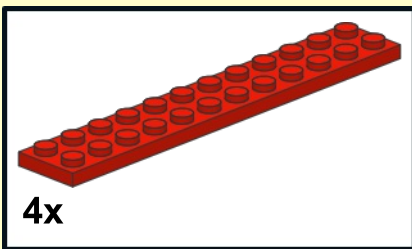

7

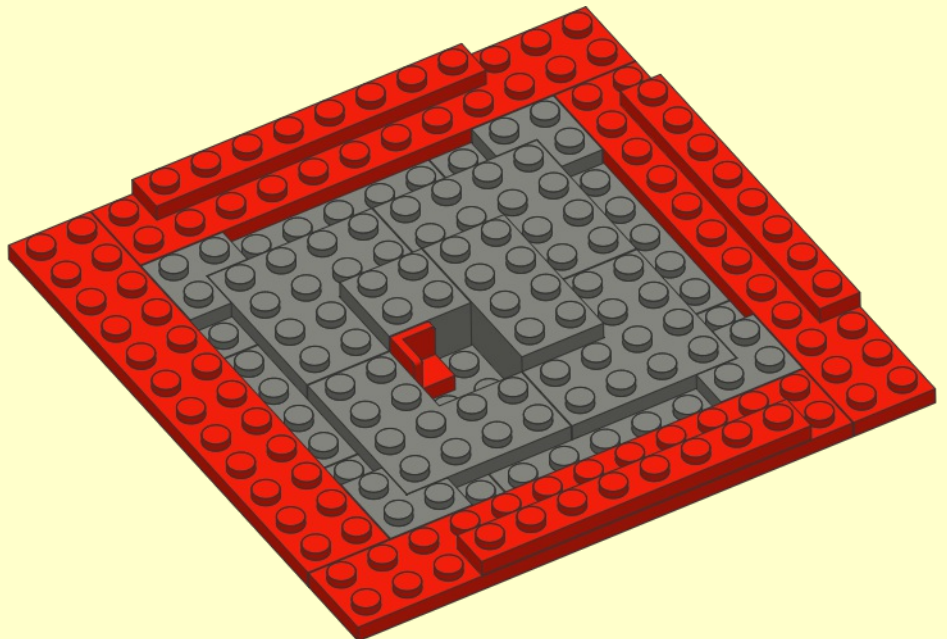
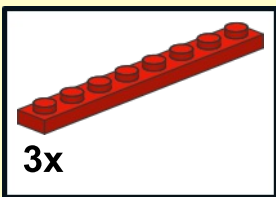

8

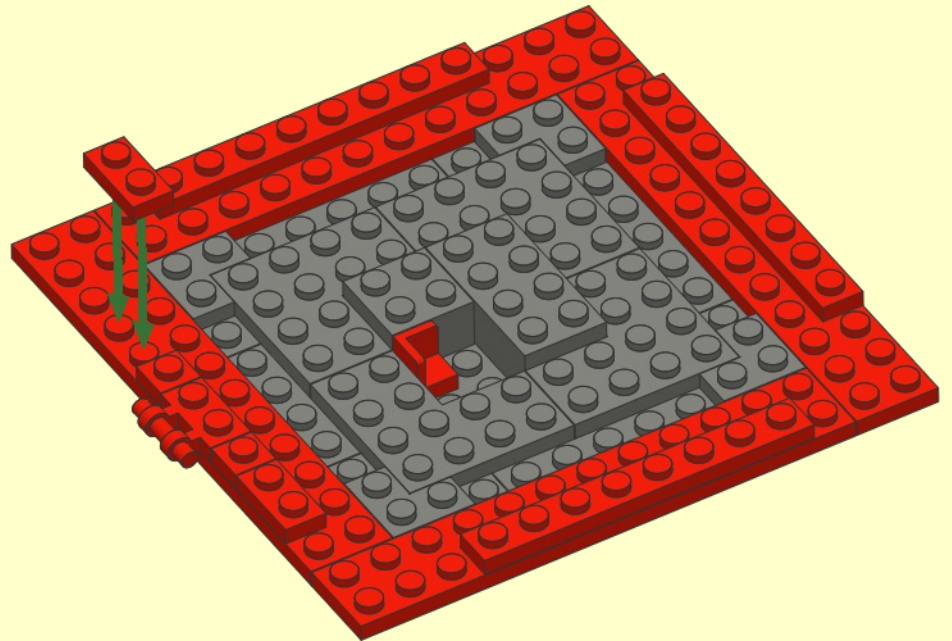
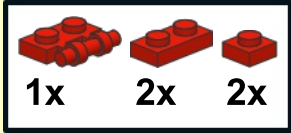

9

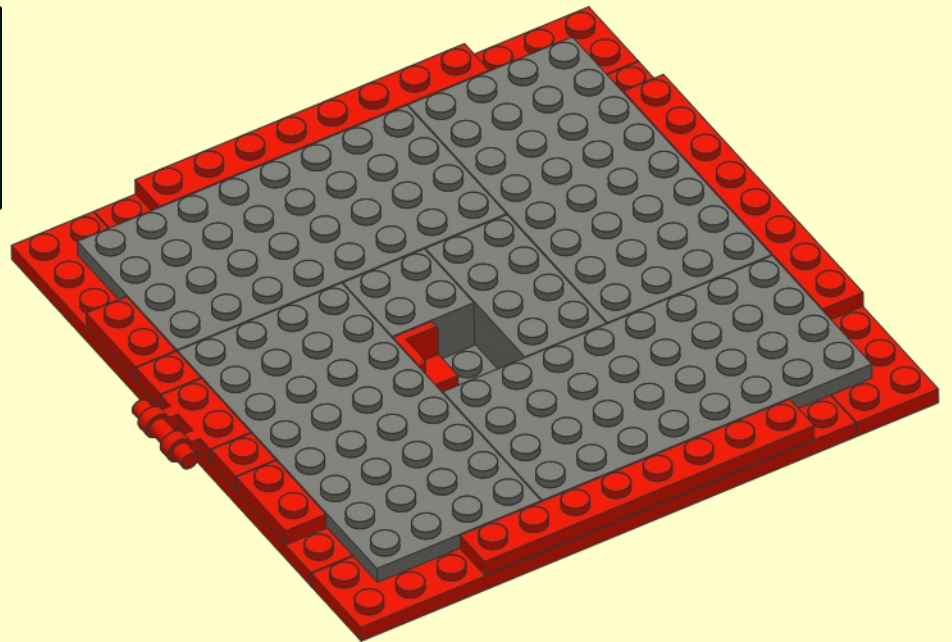
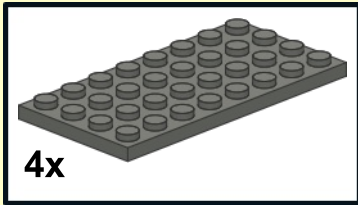

10

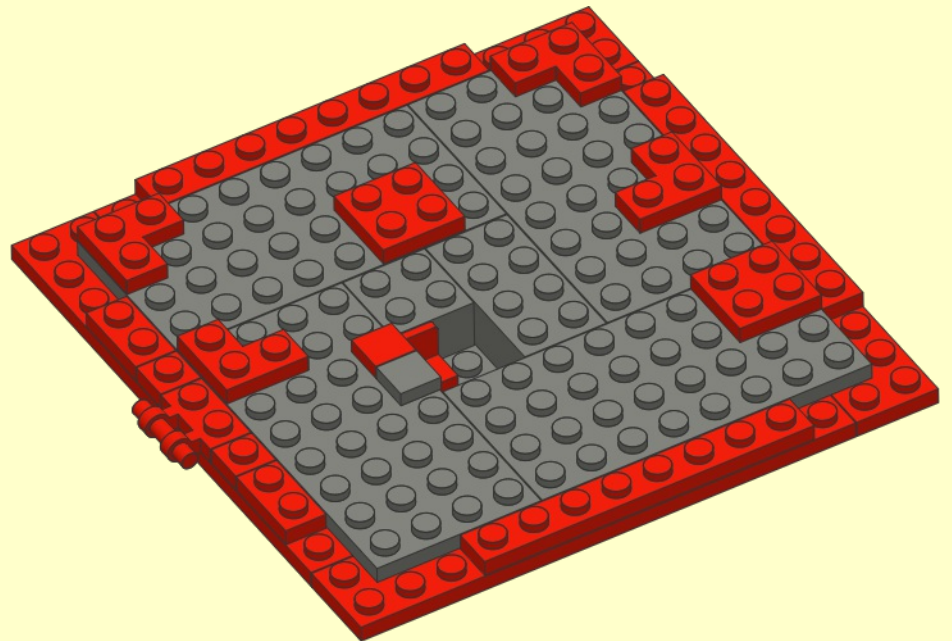
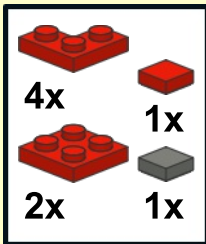

11

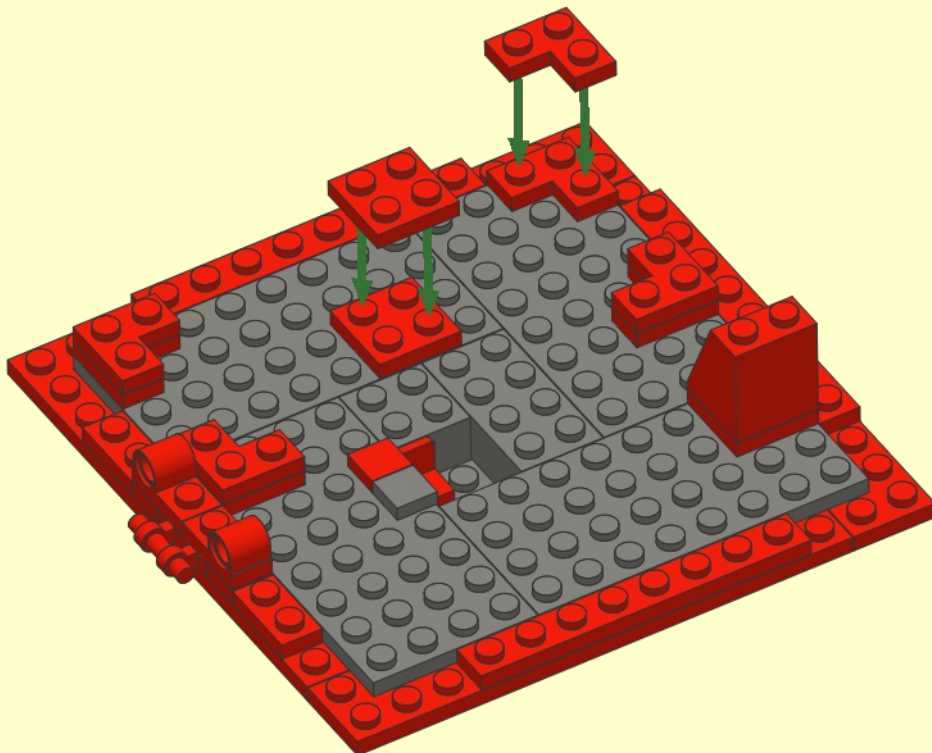
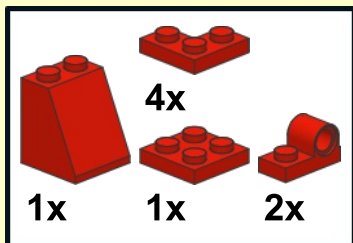

12

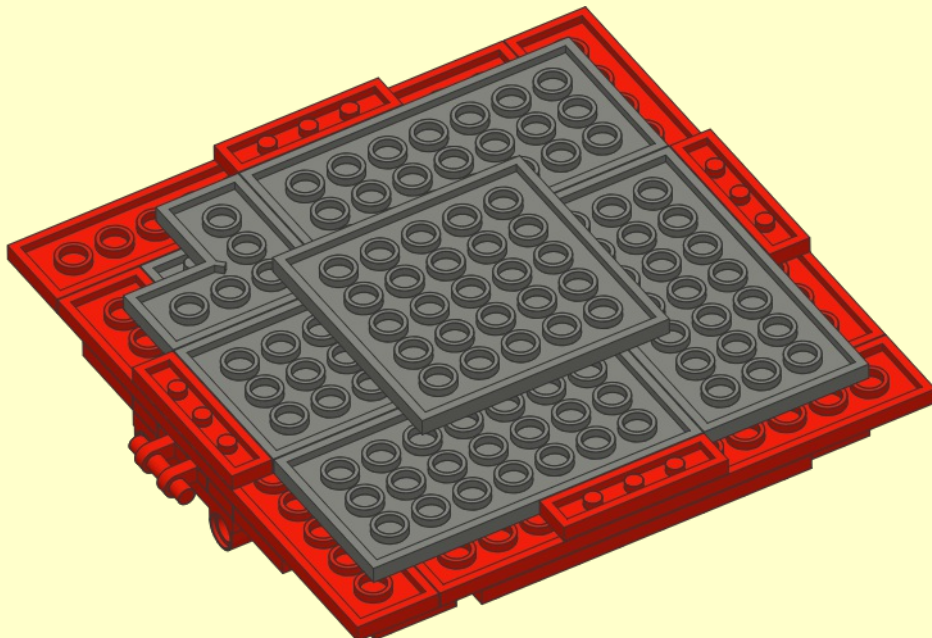
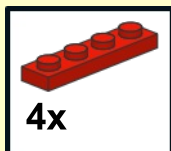

13

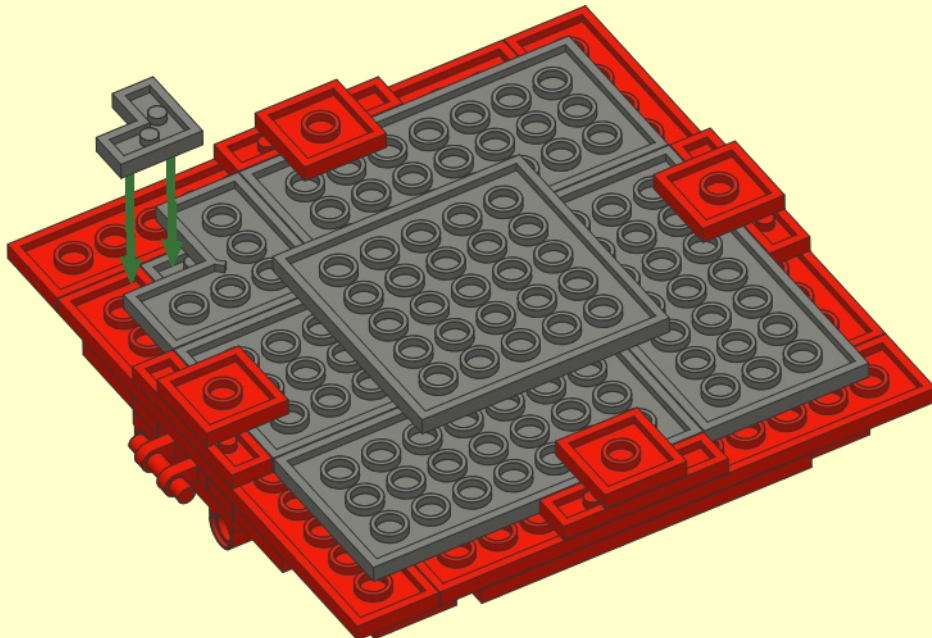
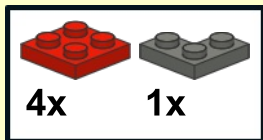

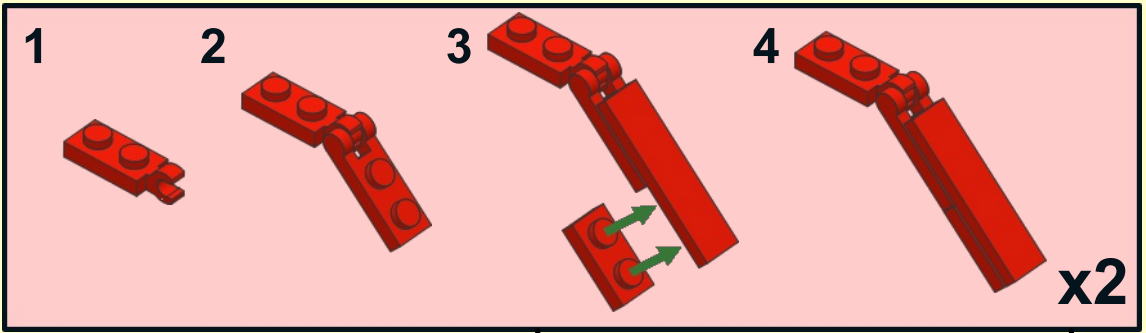

14

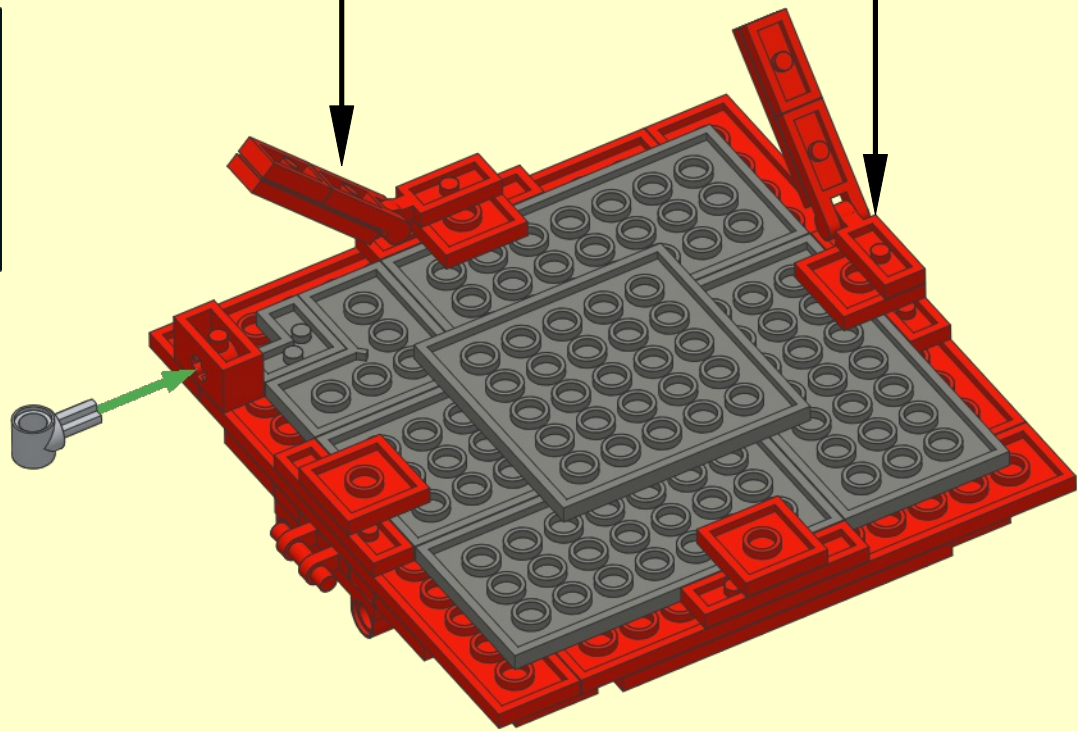
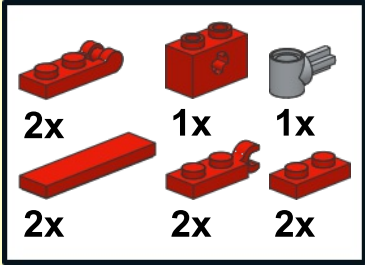

15

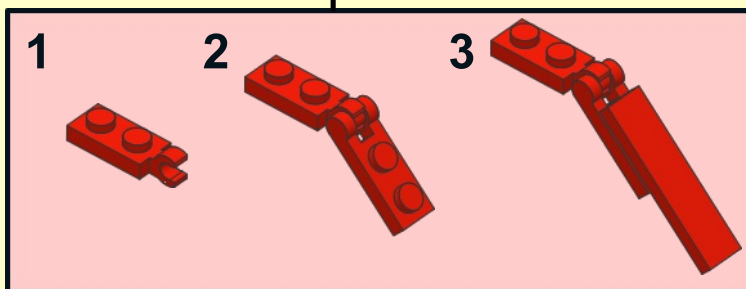
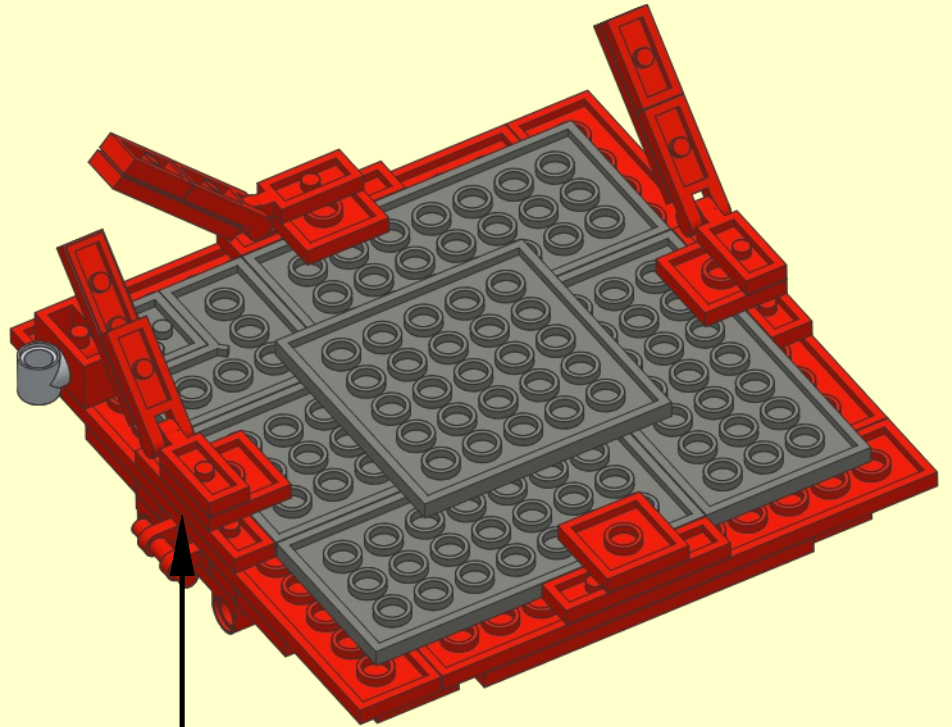
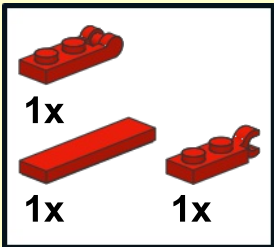

20

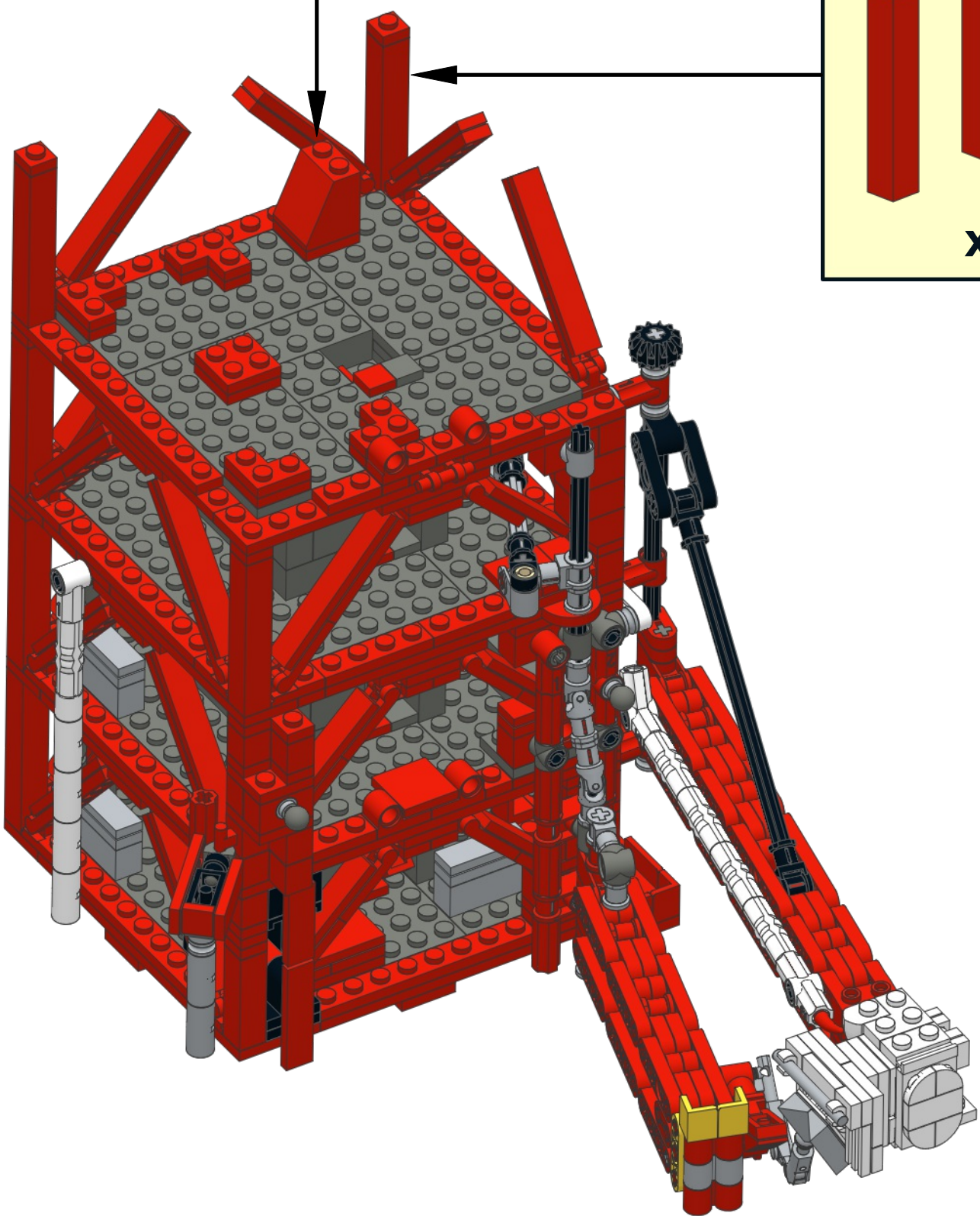
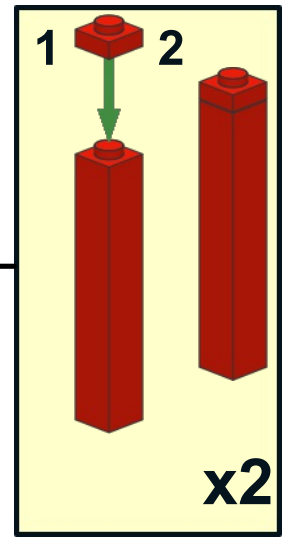
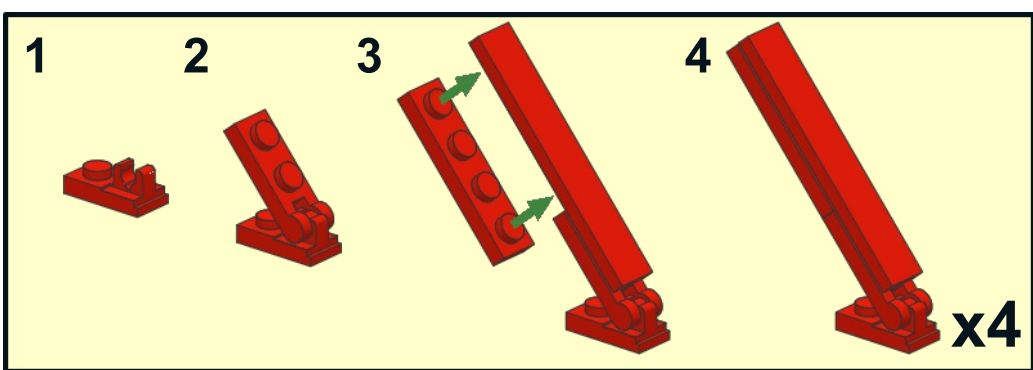
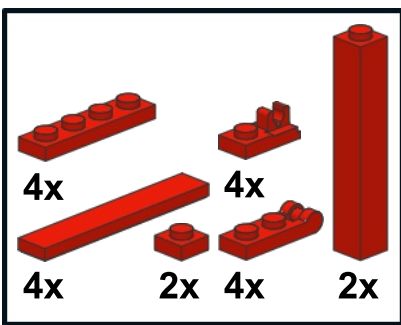

1

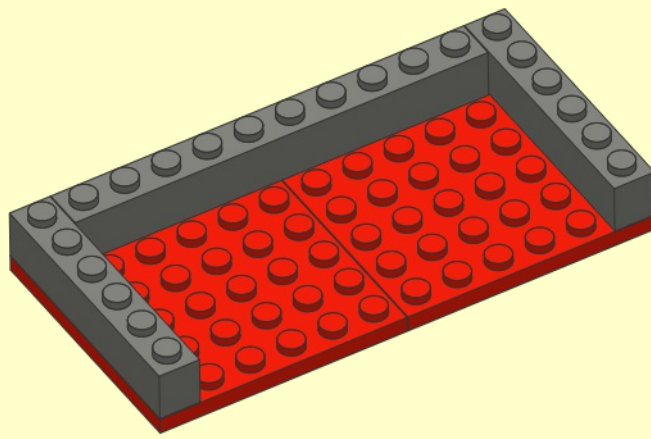
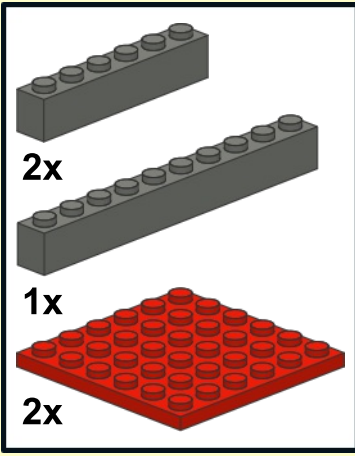

2

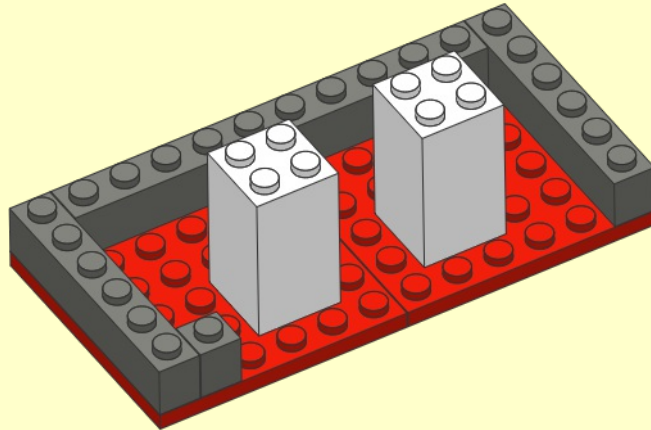
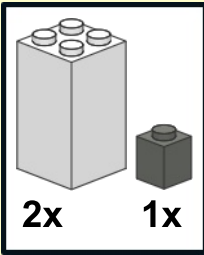

3

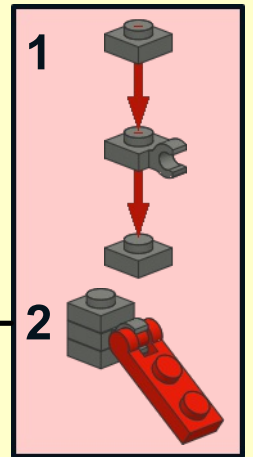
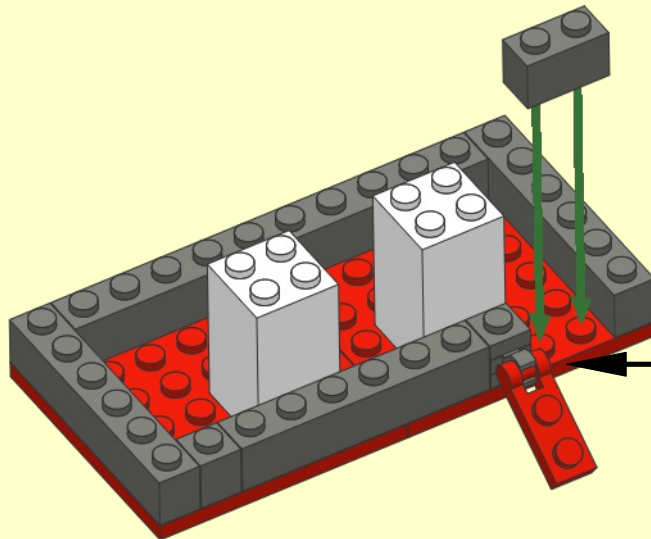
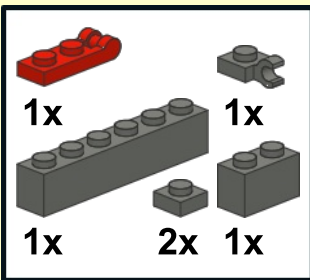

4

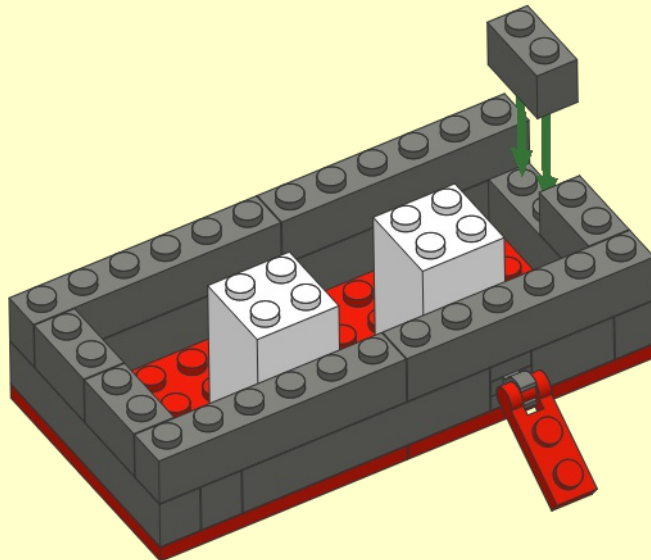
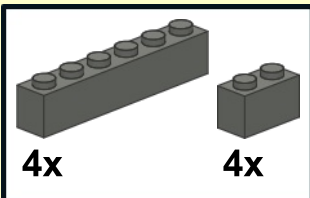

5

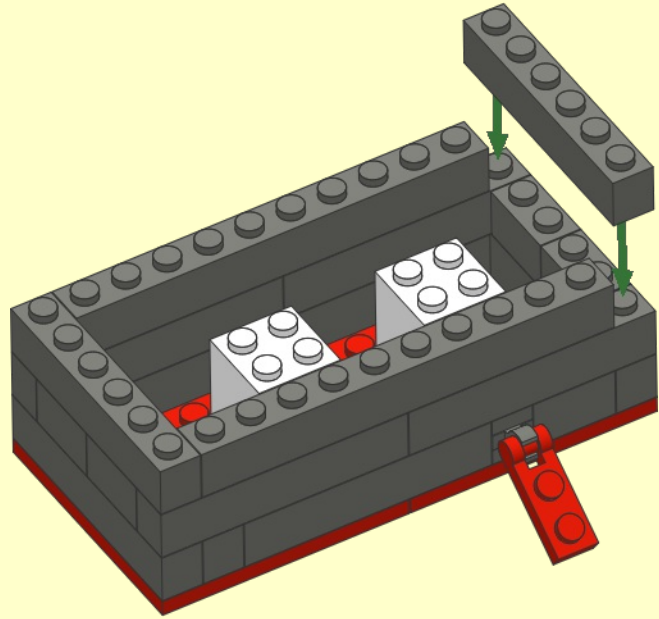
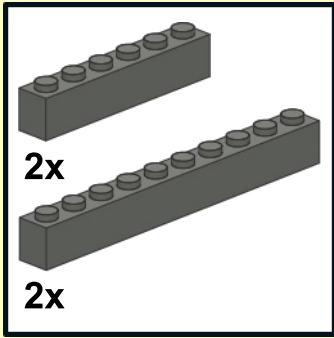

6

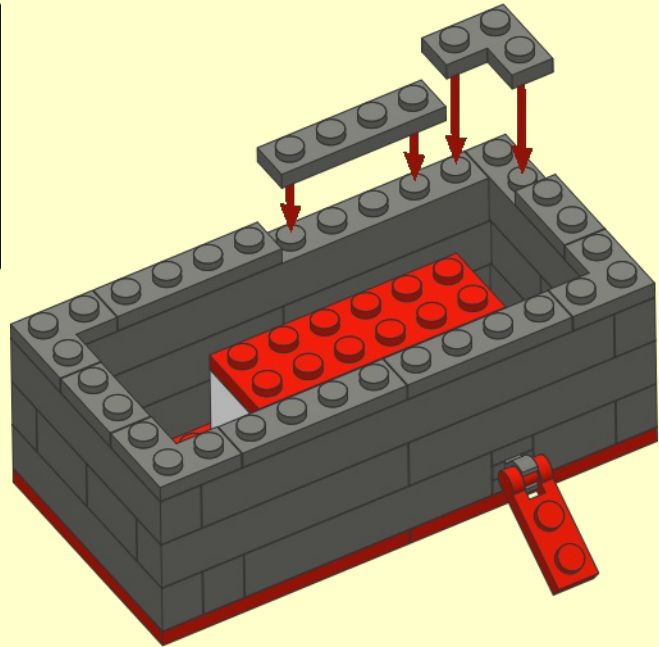
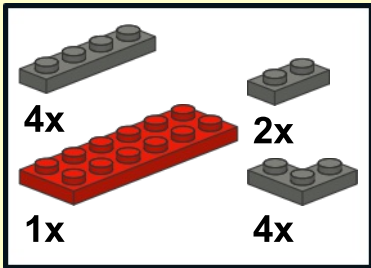

7

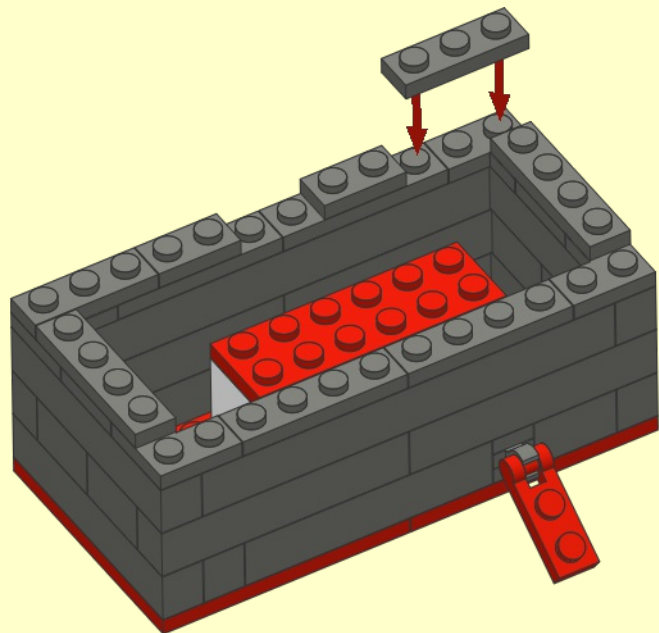
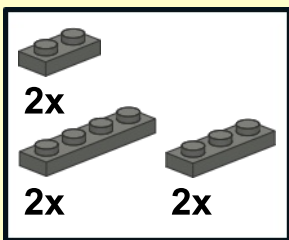



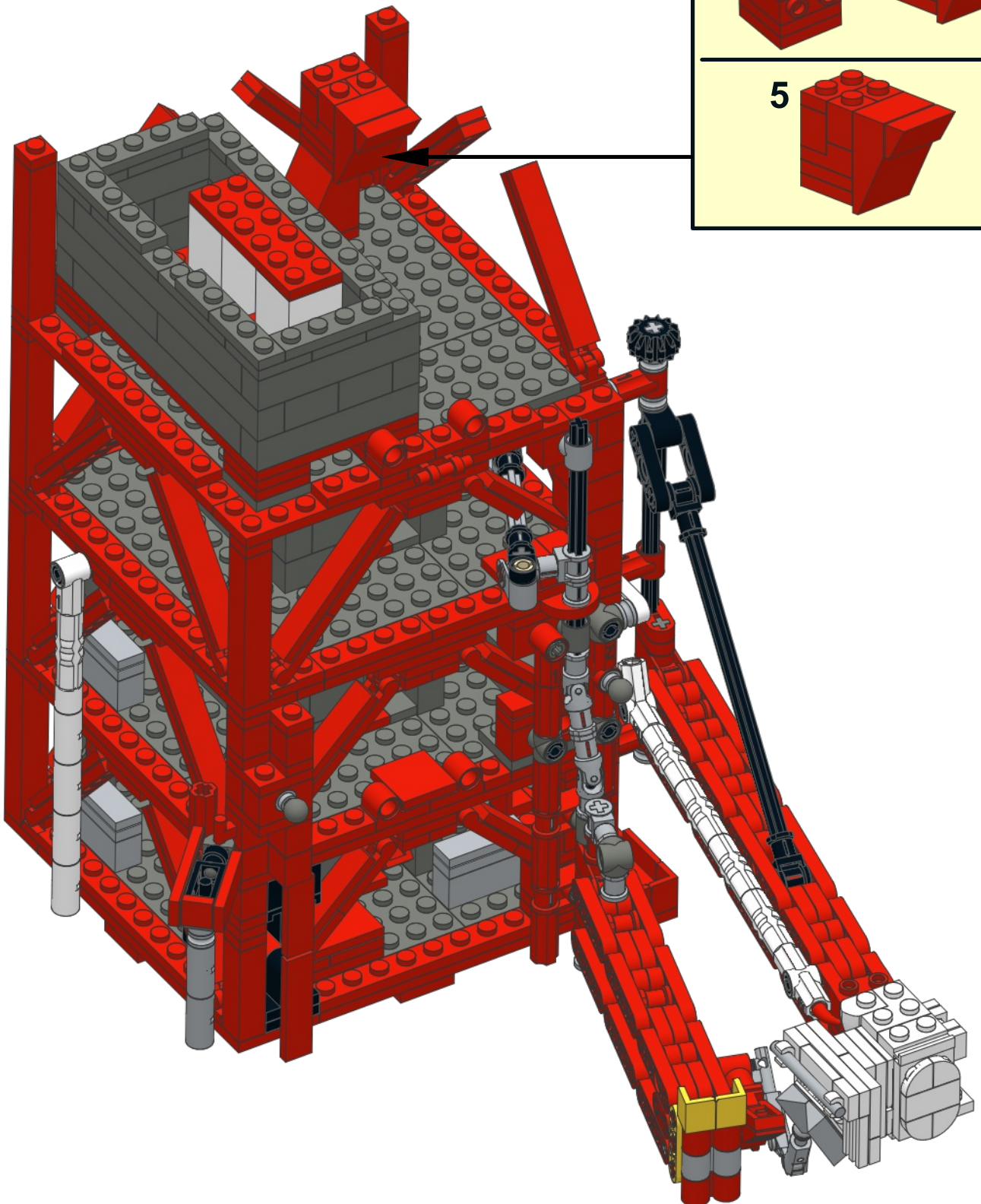
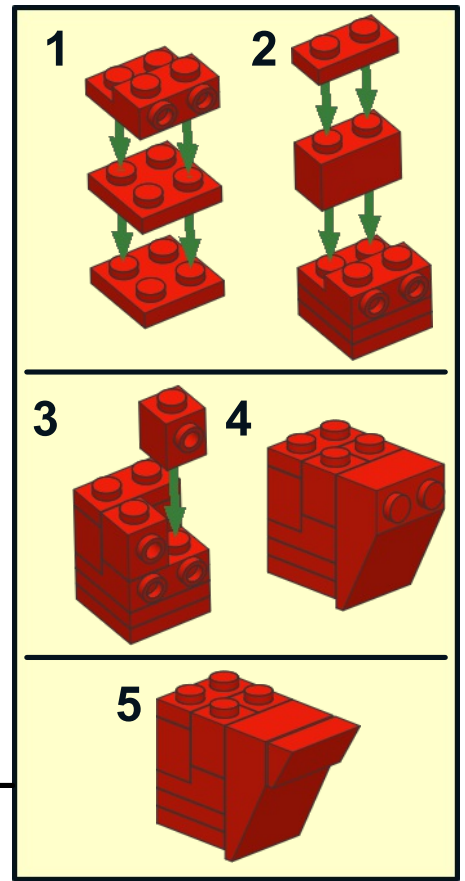
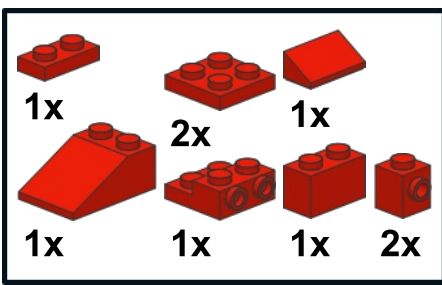

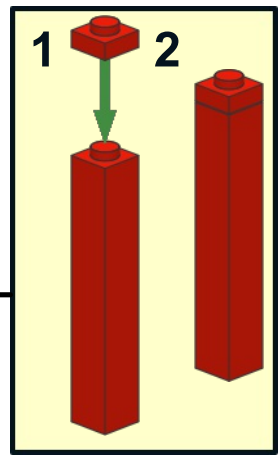
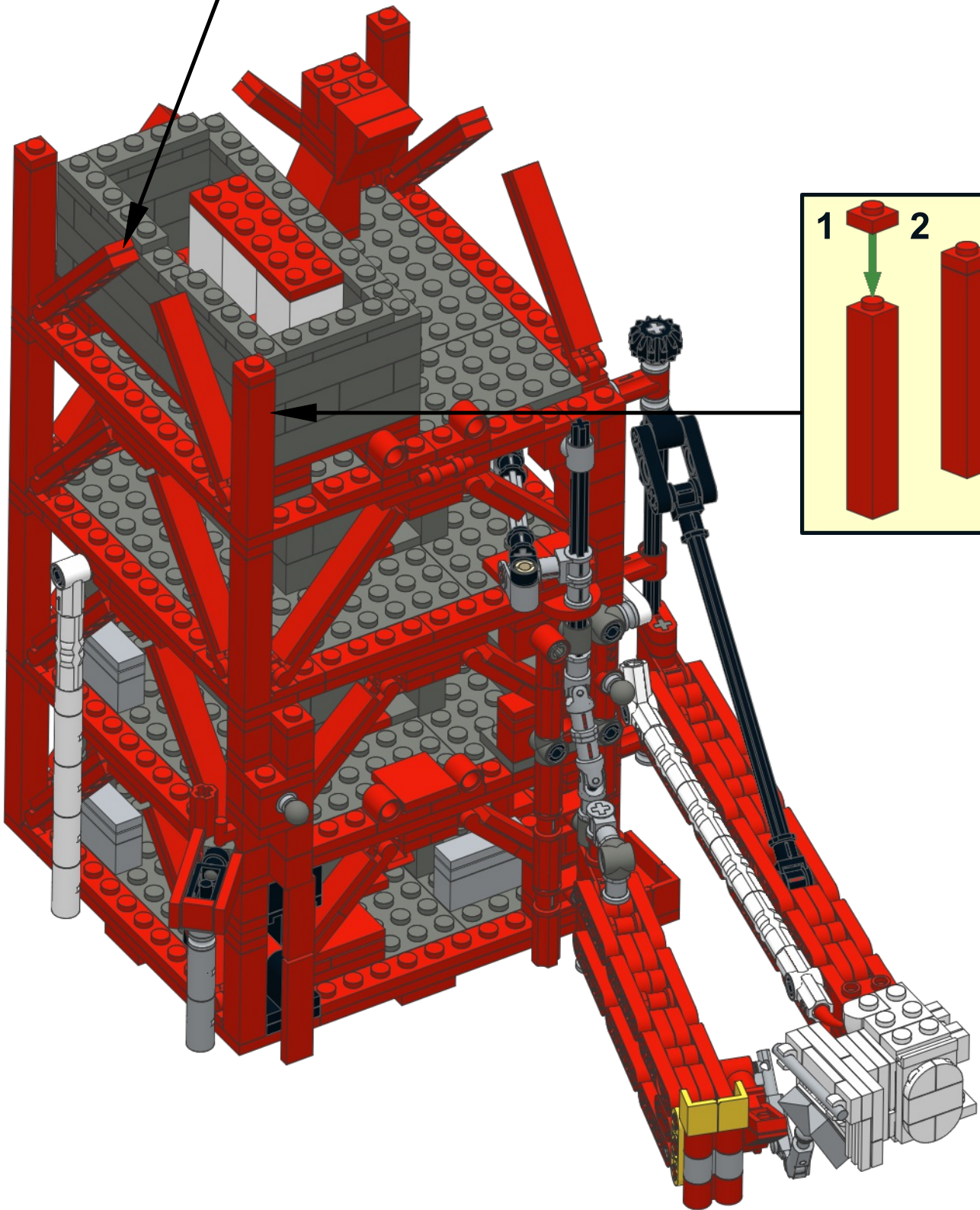
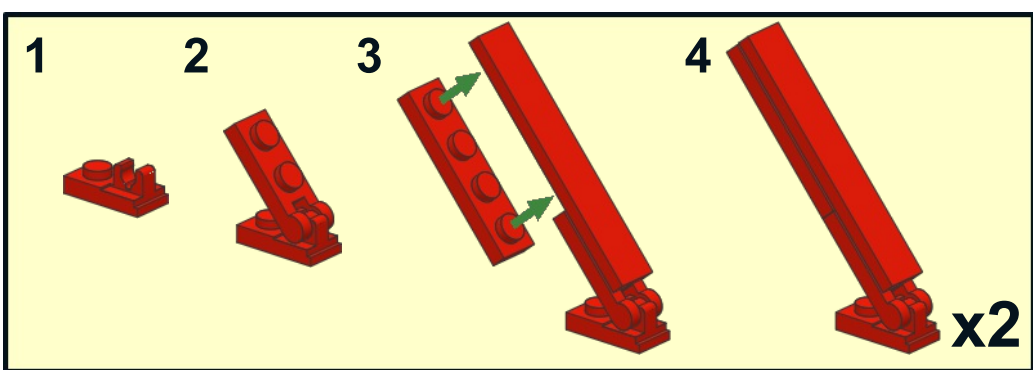
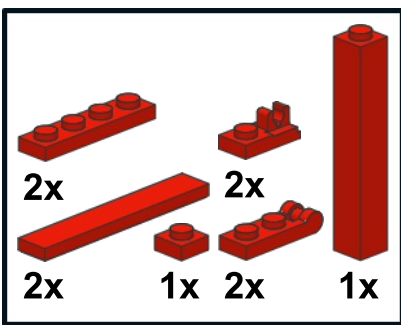

# 23

- 1x
- 2x
- 2x
- 2x
- 2x
- 2x
- 1x
- 2x
- 1x
- 1x
- 1x
- 1x

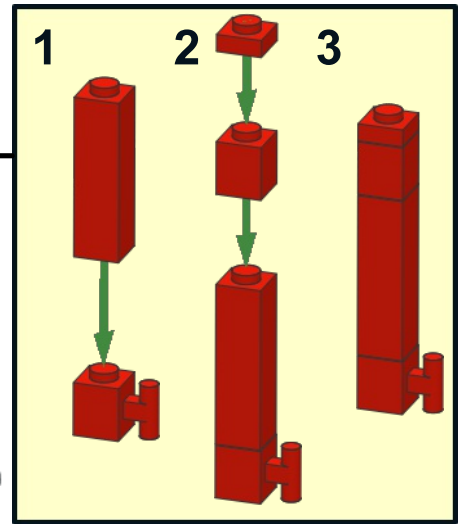
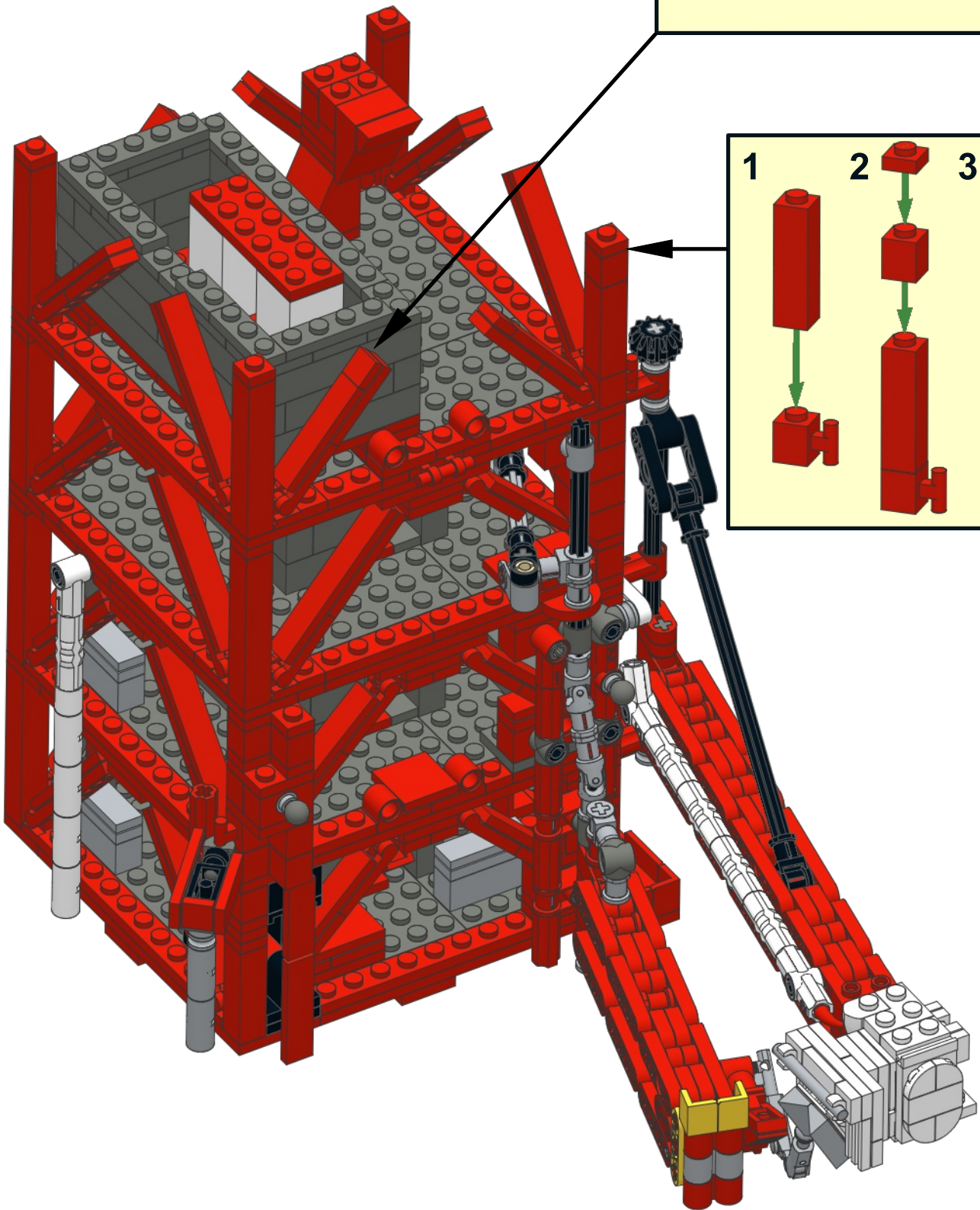
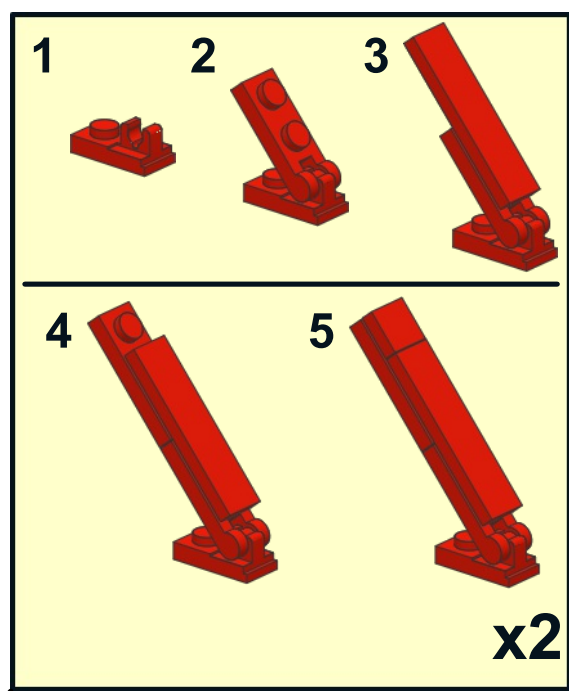

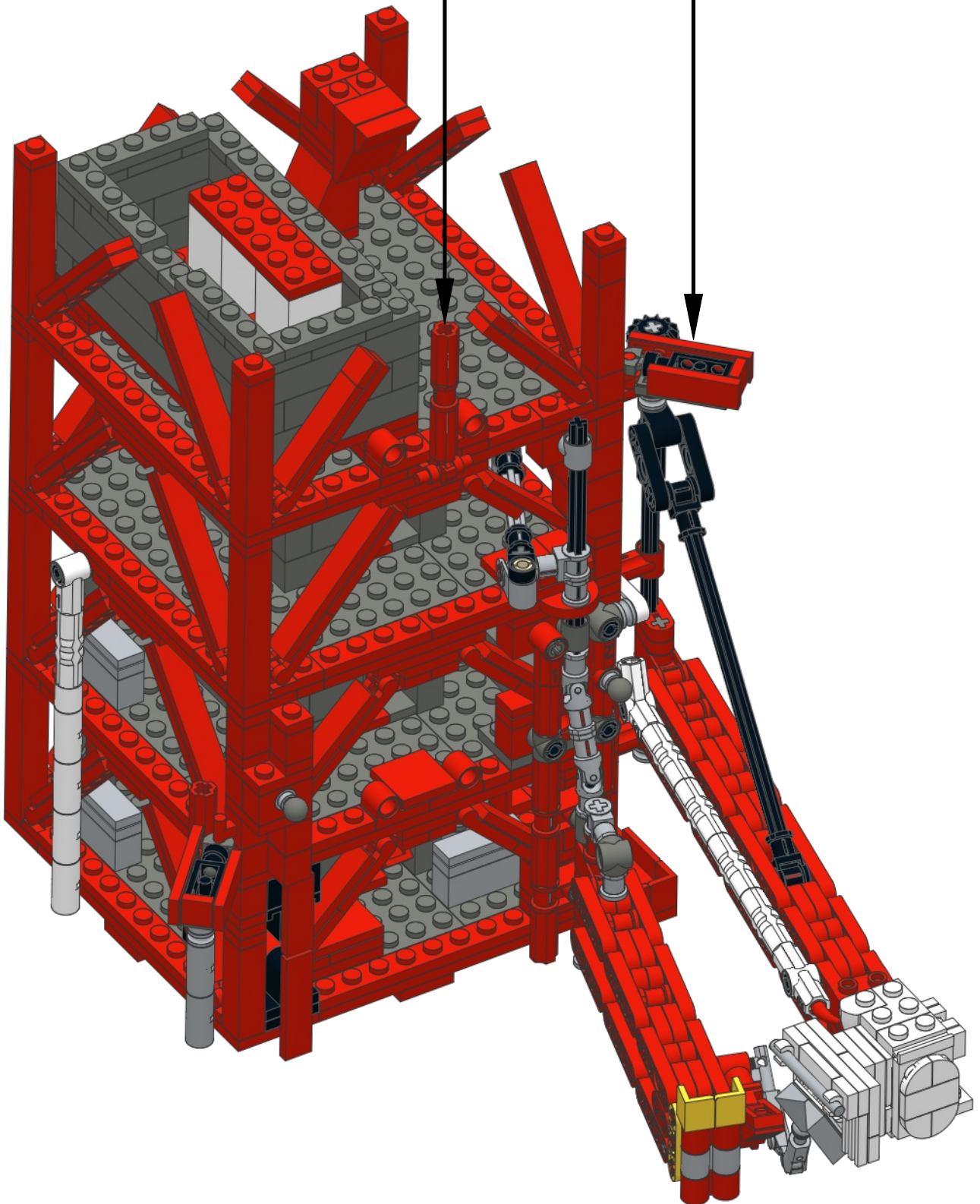
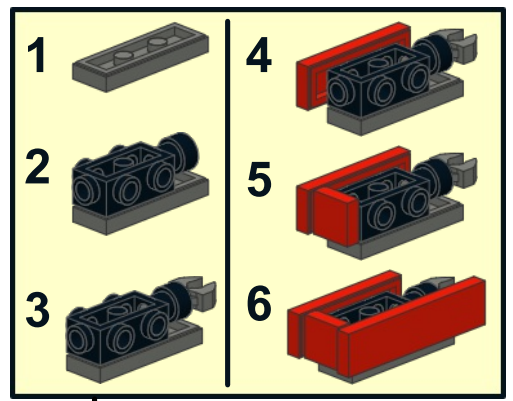
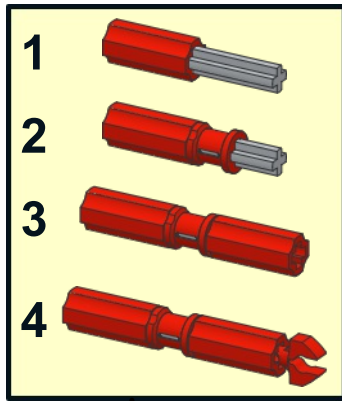
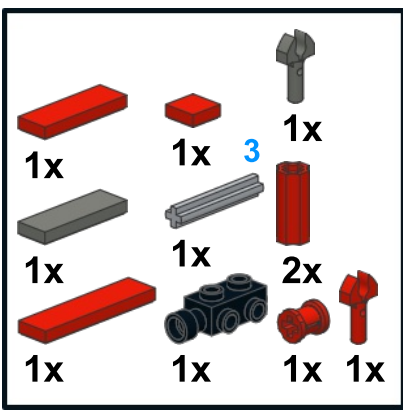

1

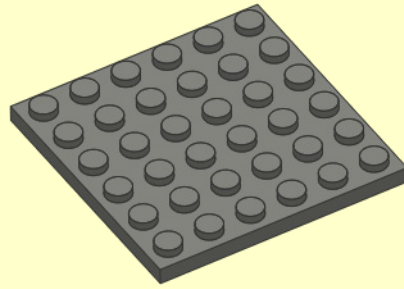
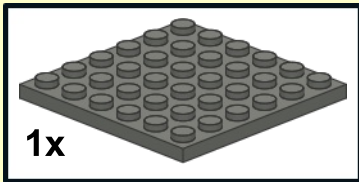

2

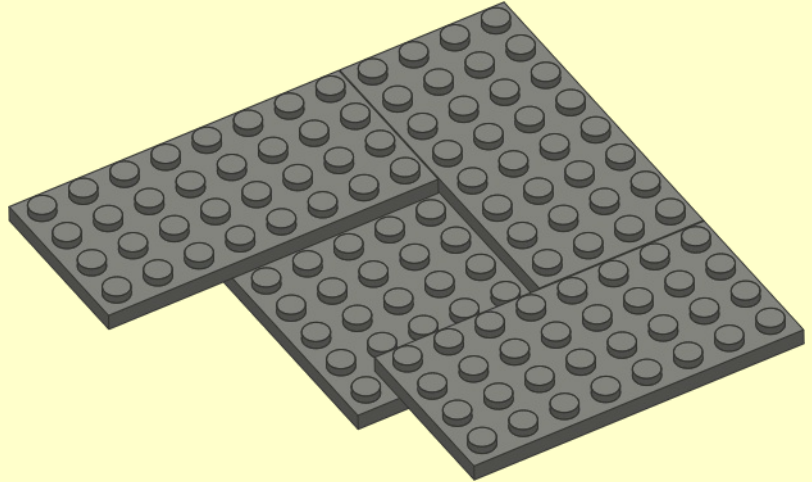
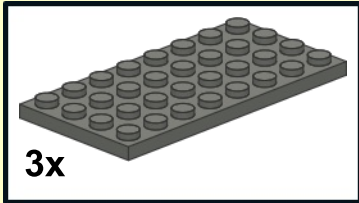

3

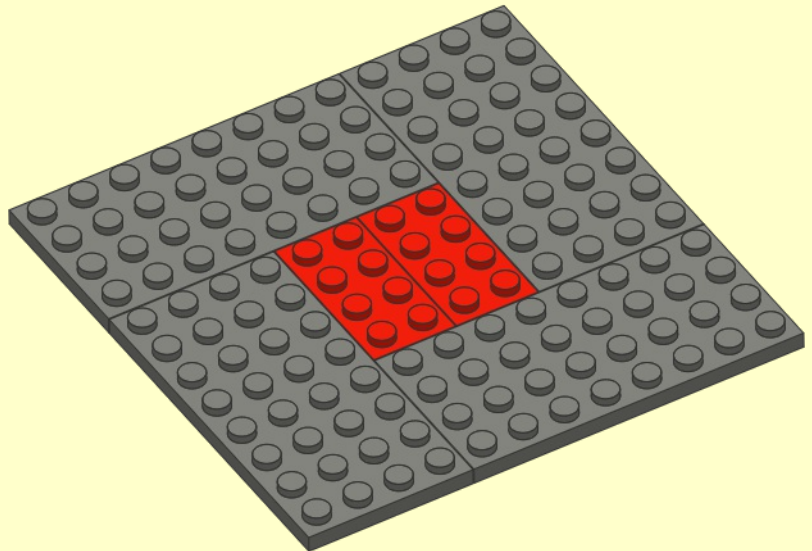
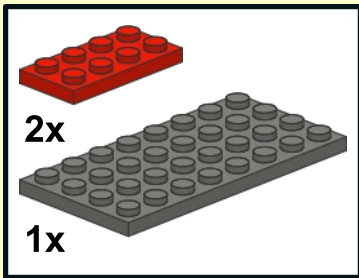

4

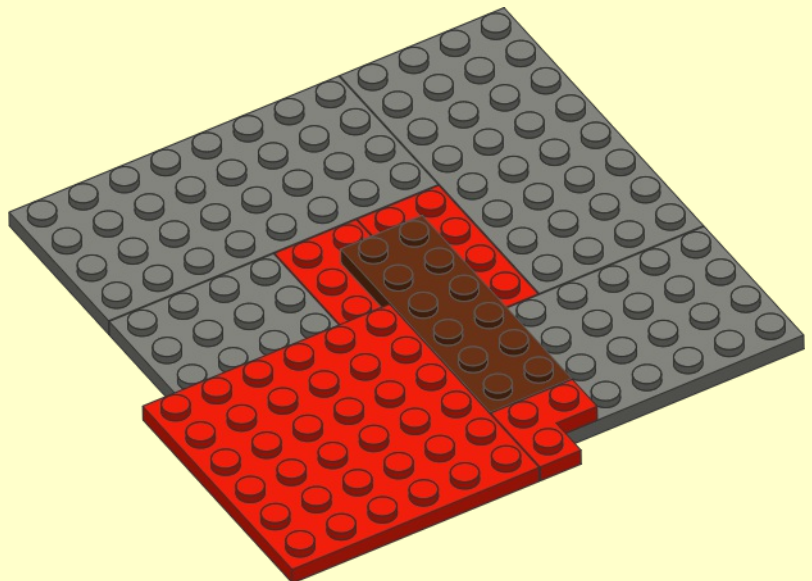
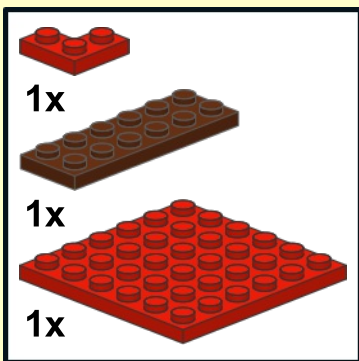

5

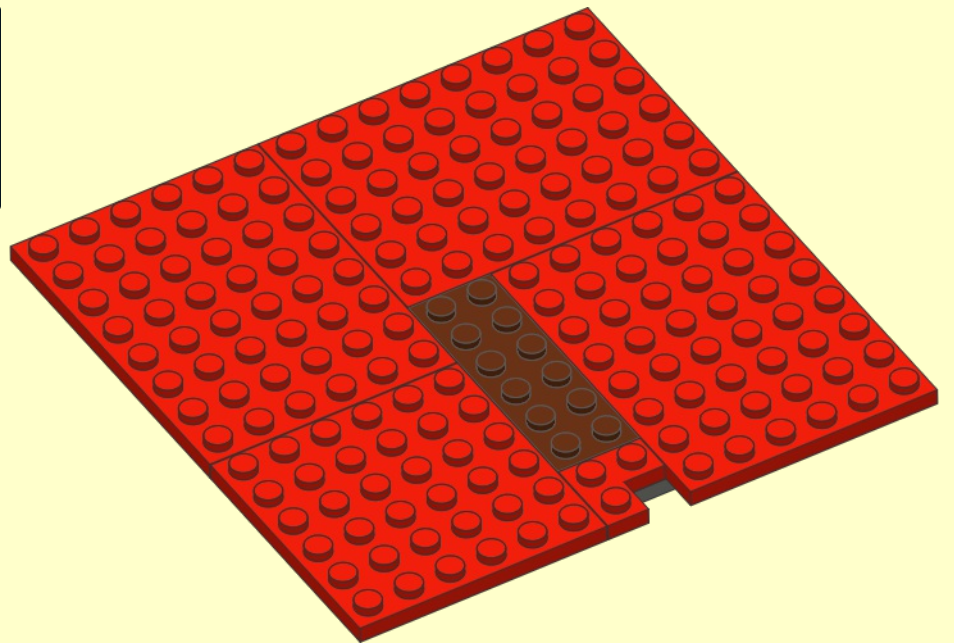
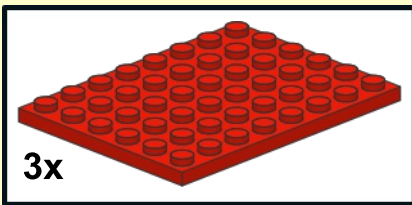

6

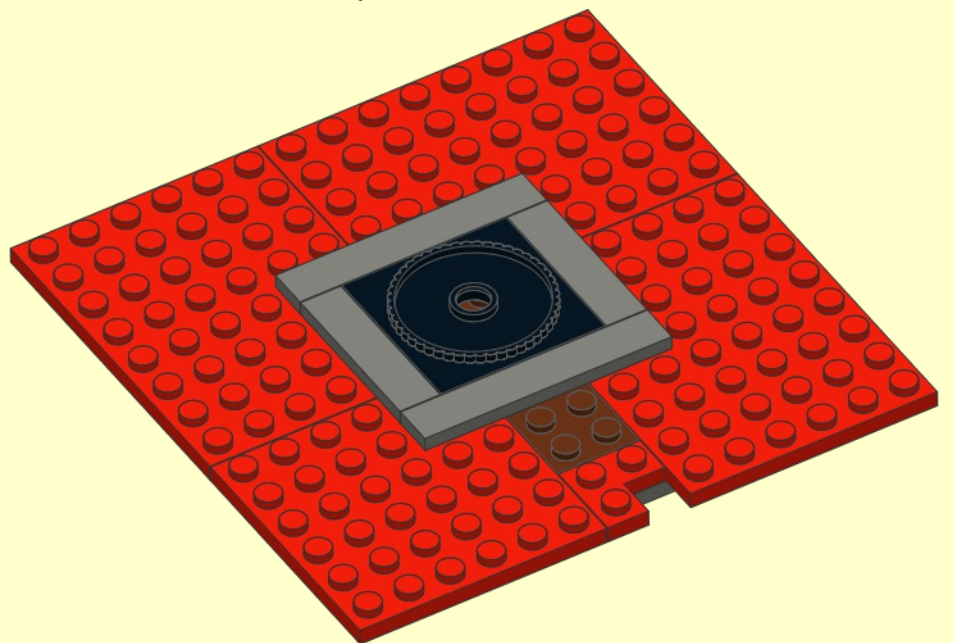
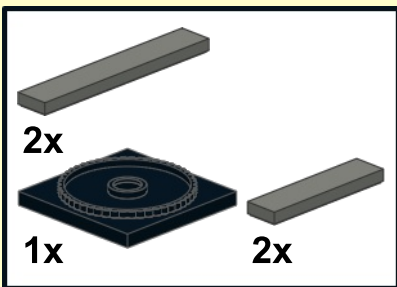

7

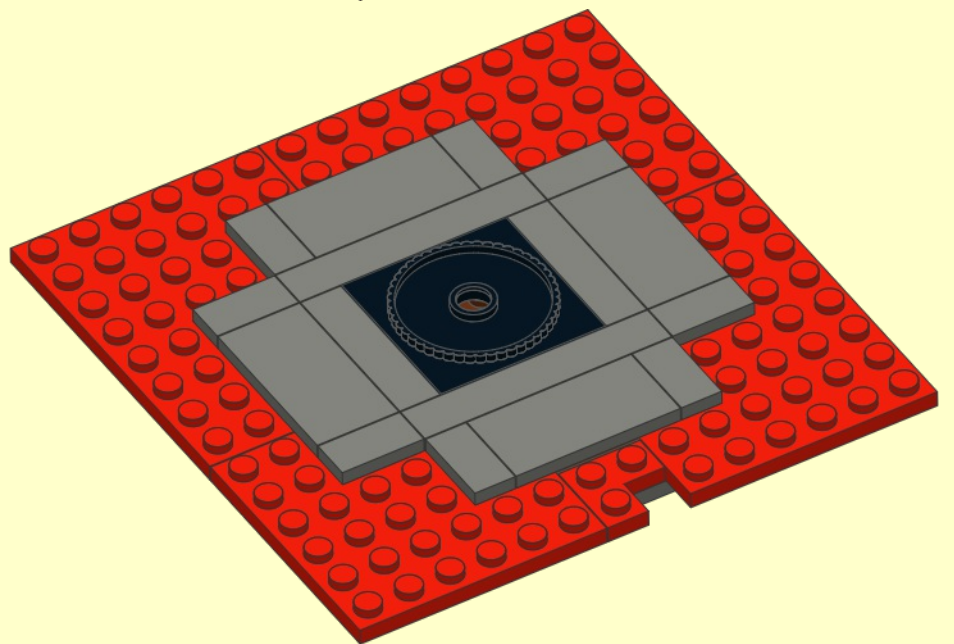
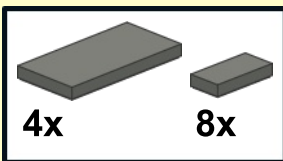

8

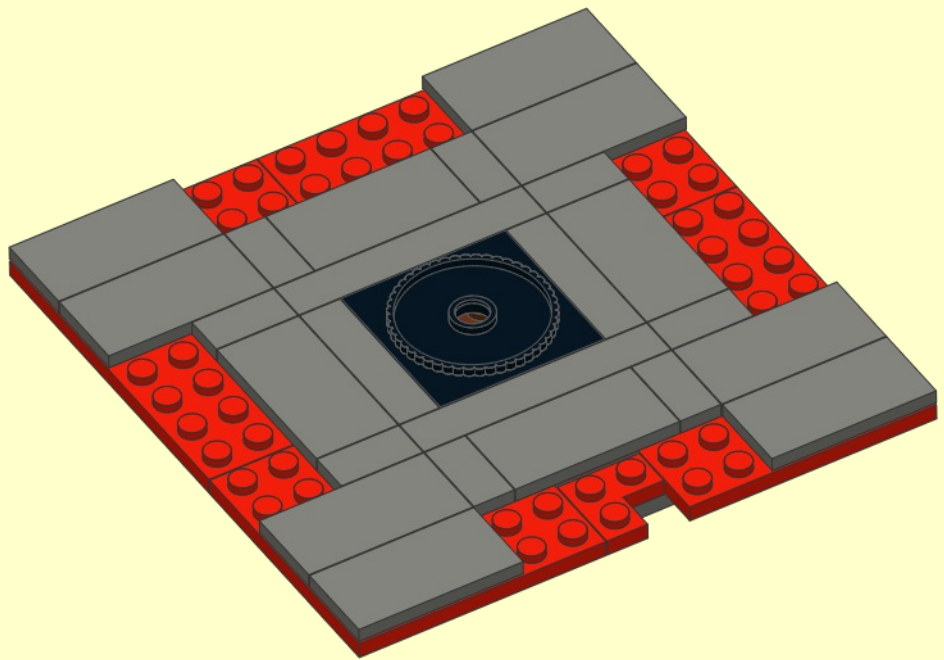
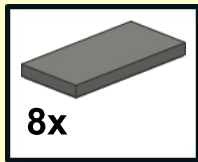

9

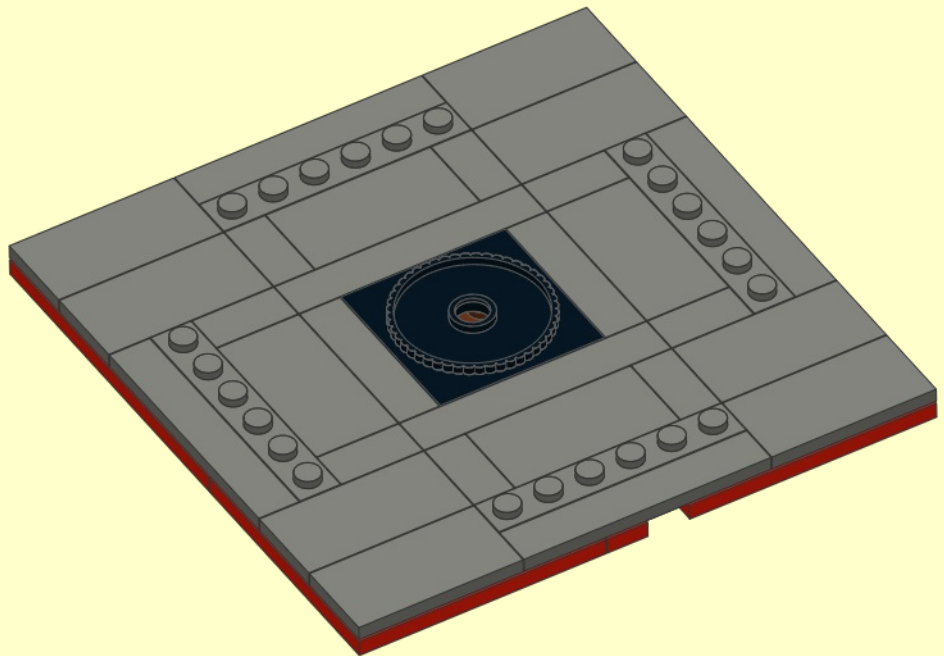
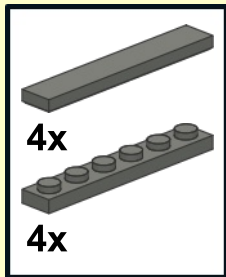

10

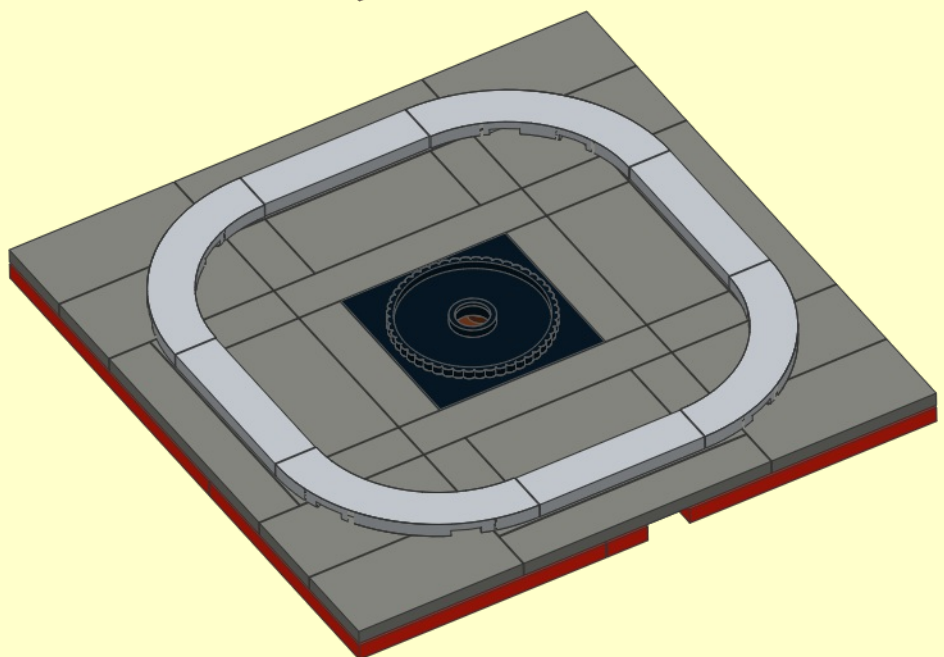
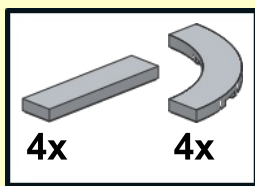

11

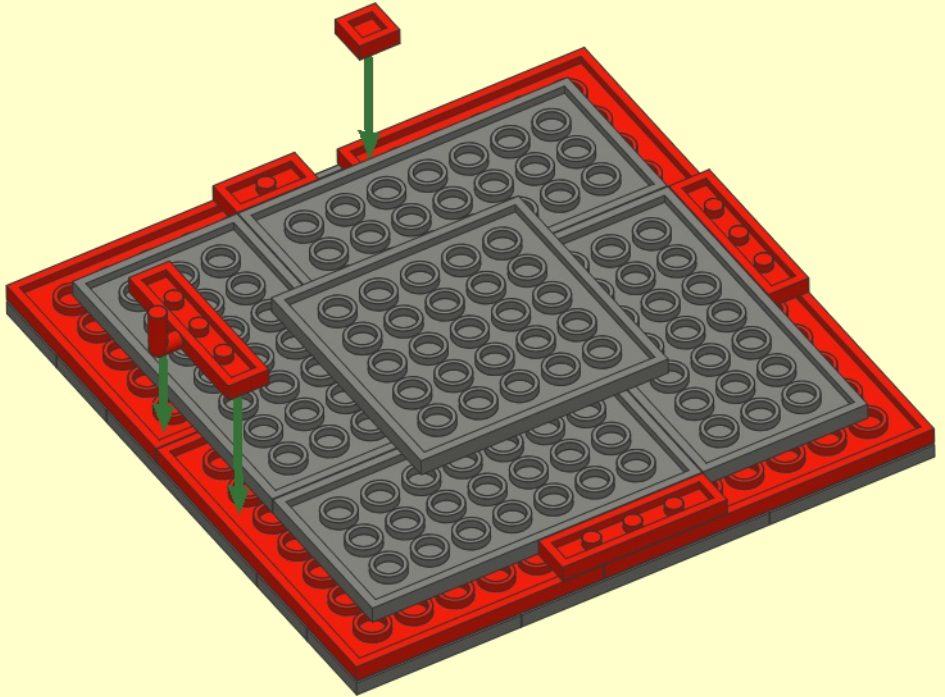
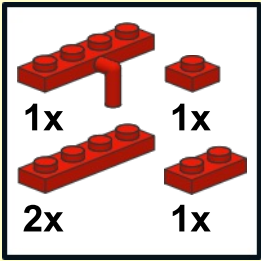

12

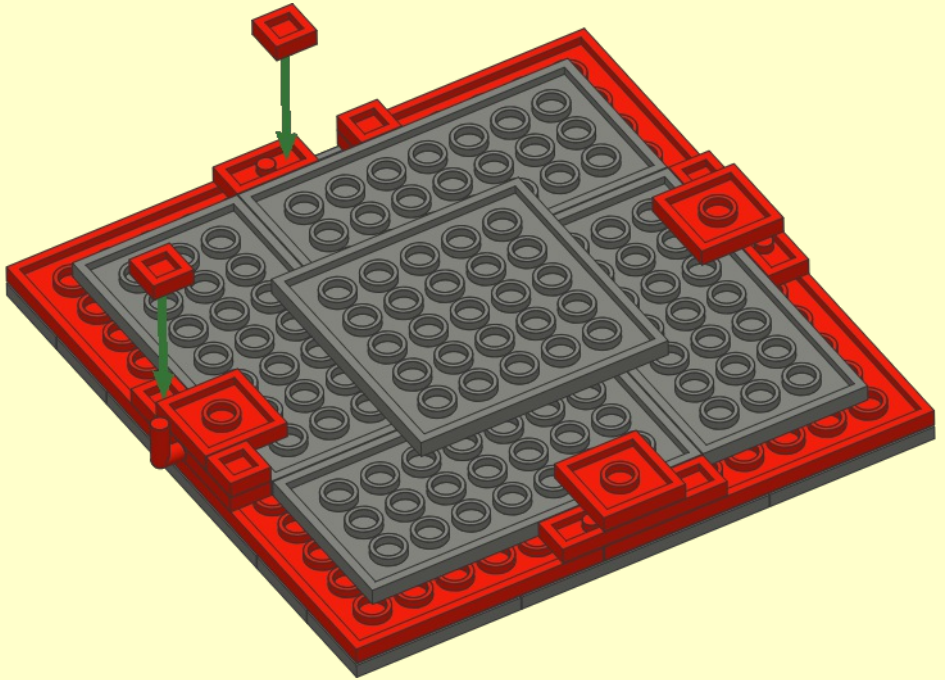
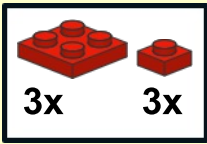

13

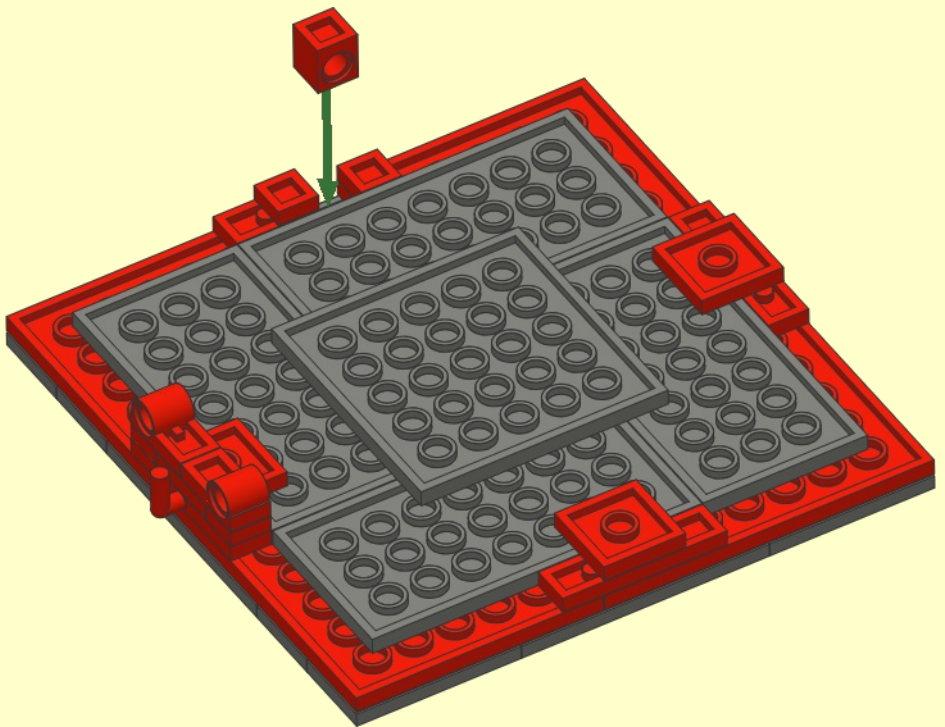
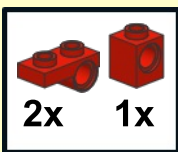



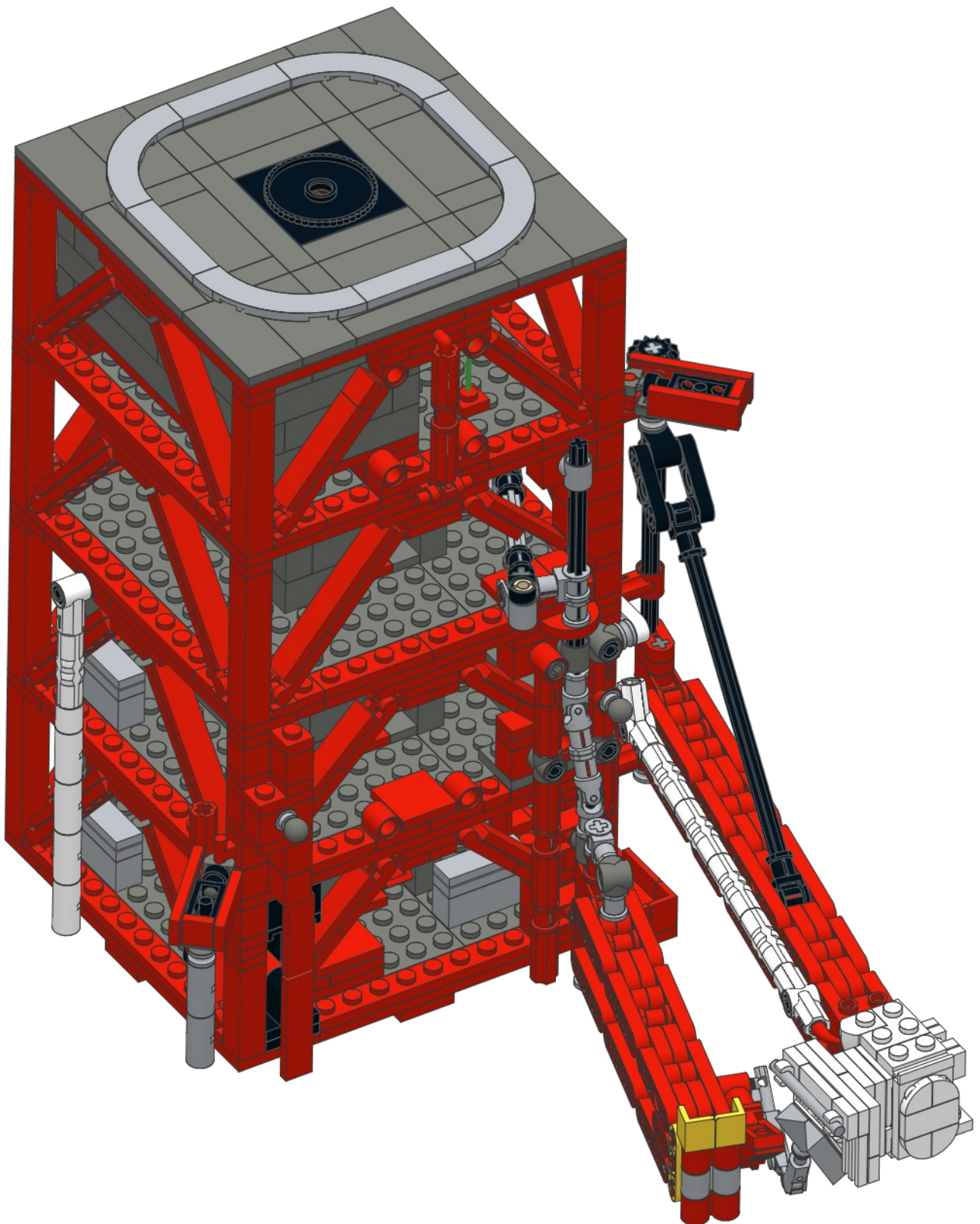

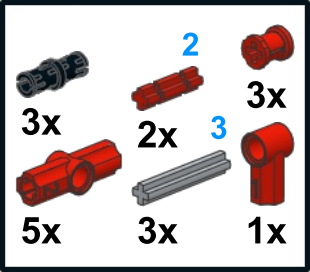

1



2

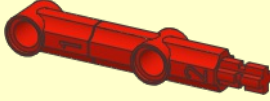

3

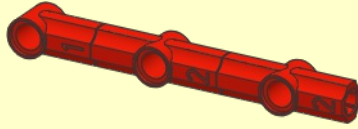

4

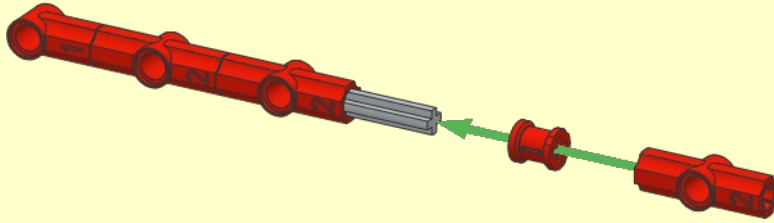

5

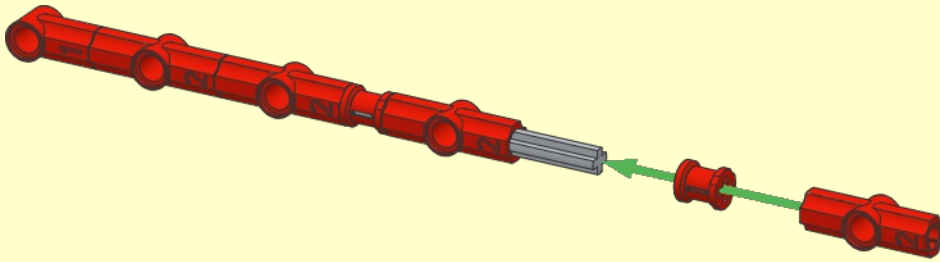

6

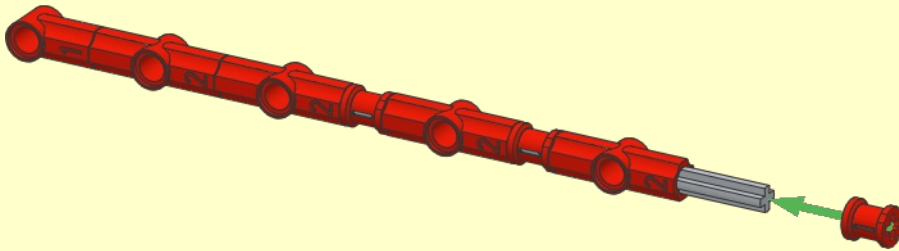

7

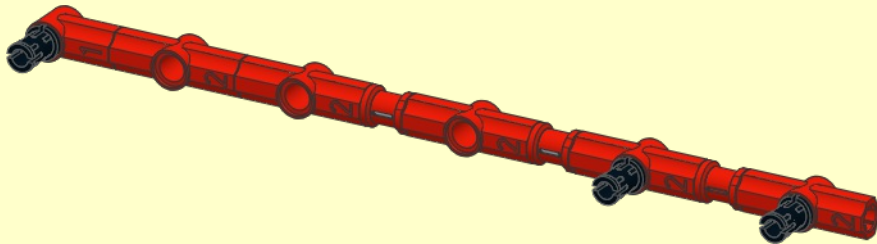

x2

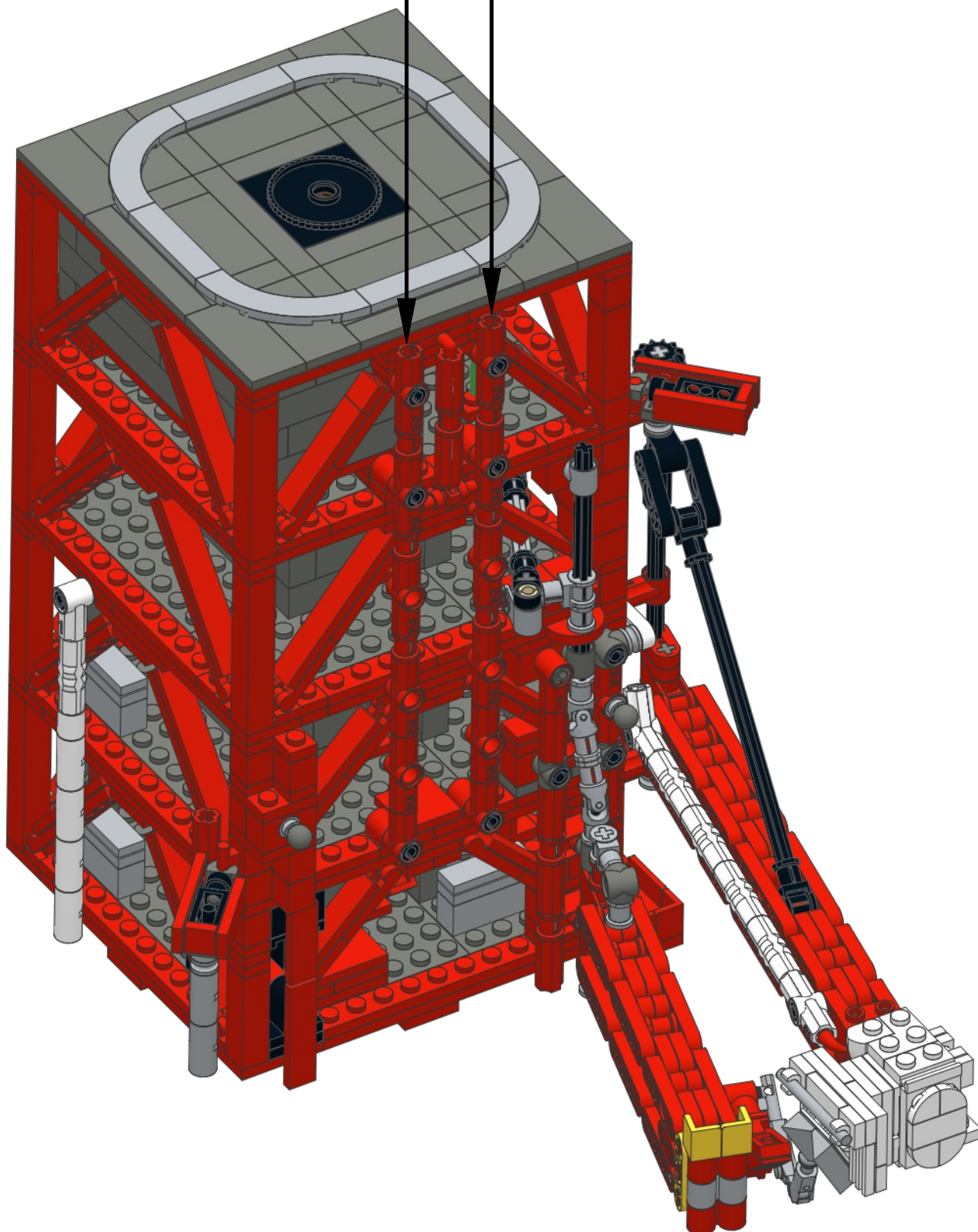
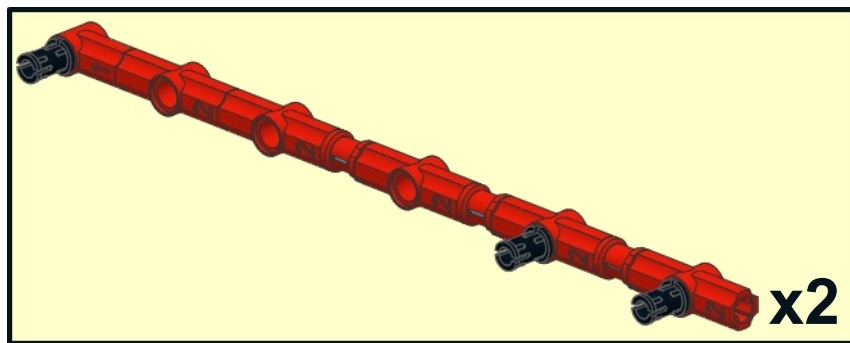

1

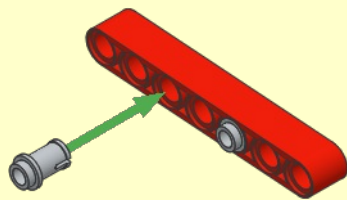
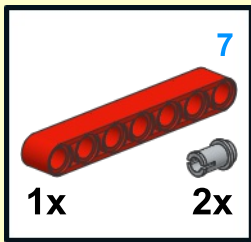

5

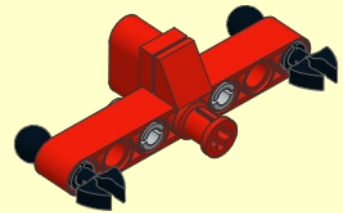

2

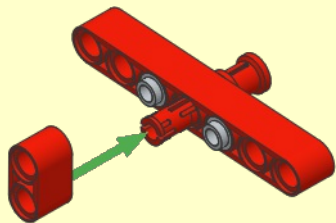
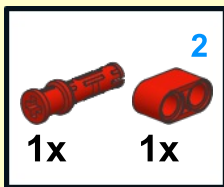

6

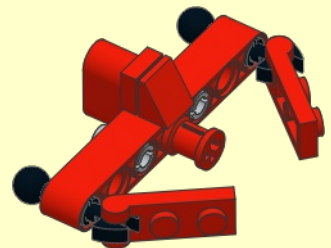

3

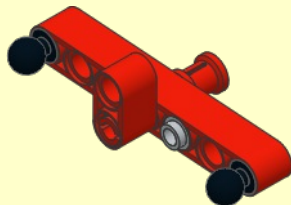

7

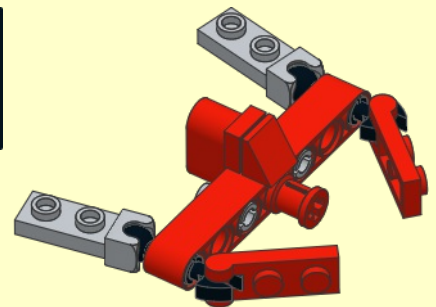
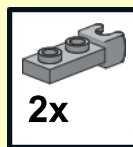

4

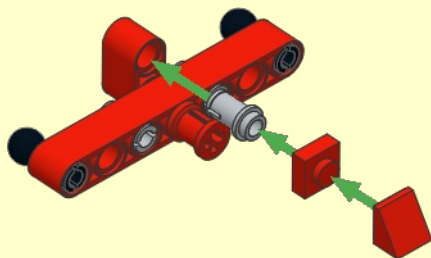
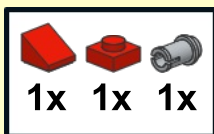

8

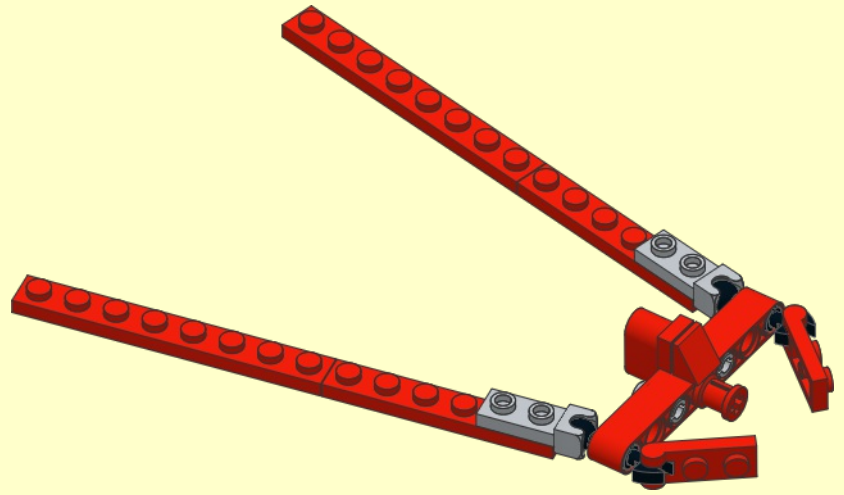
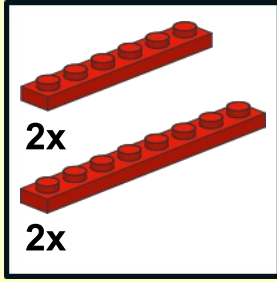

9

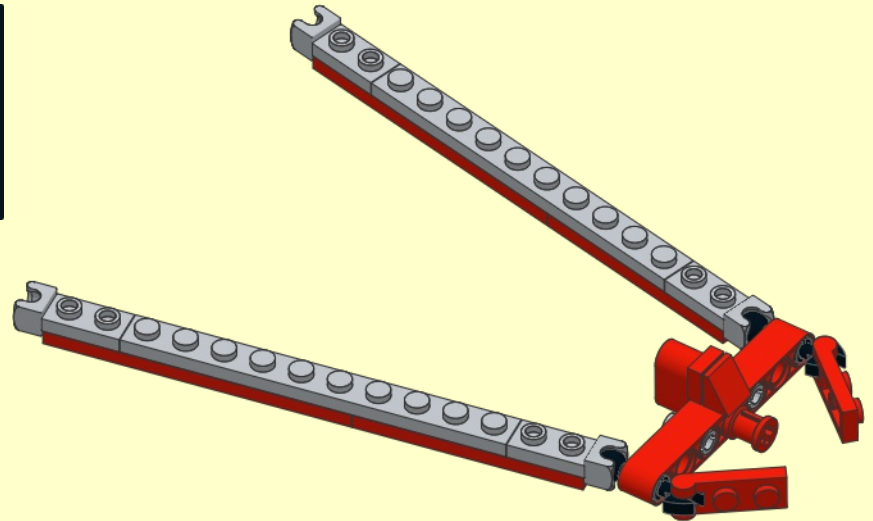
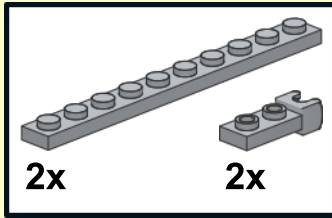

10

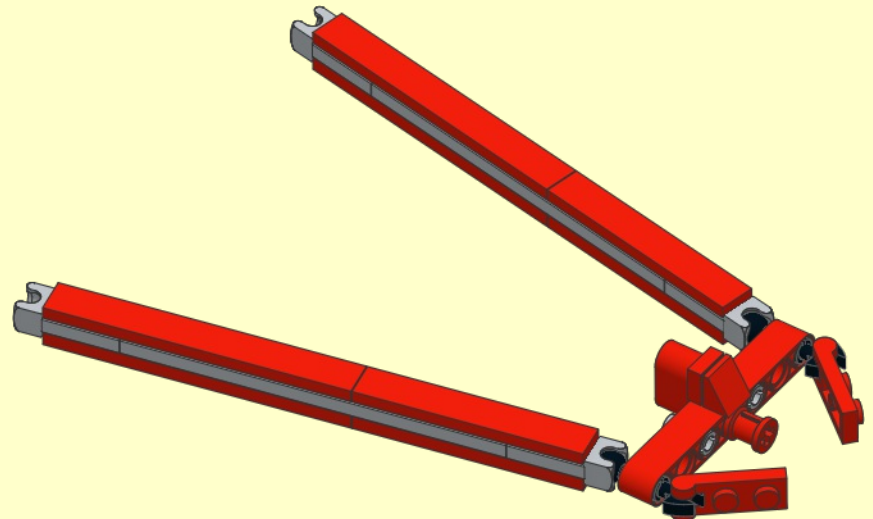
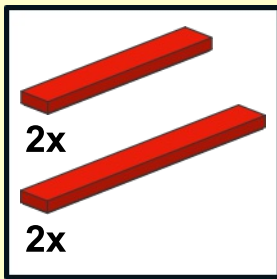

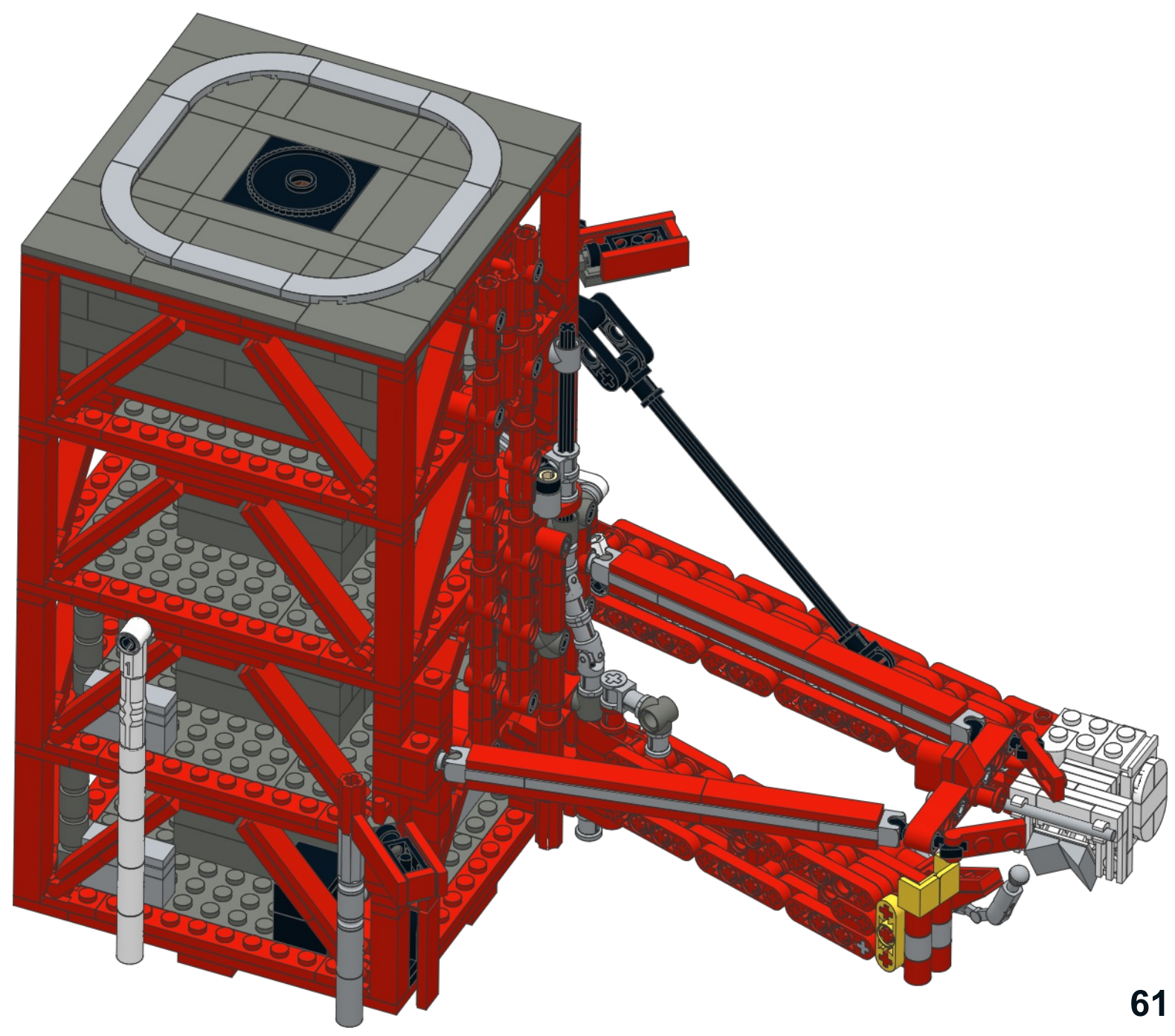

1

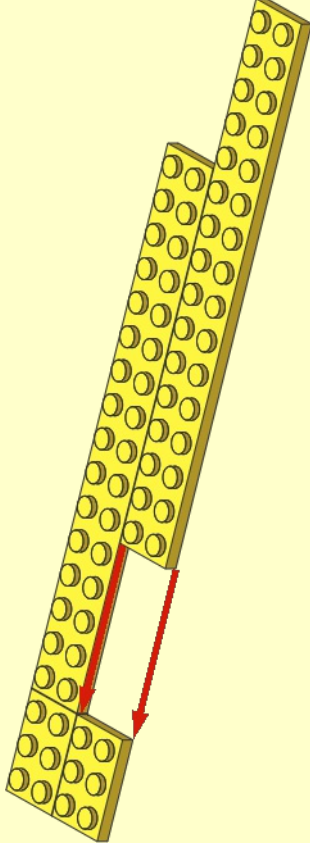
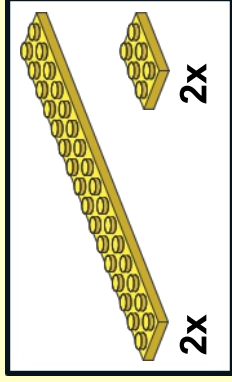

2

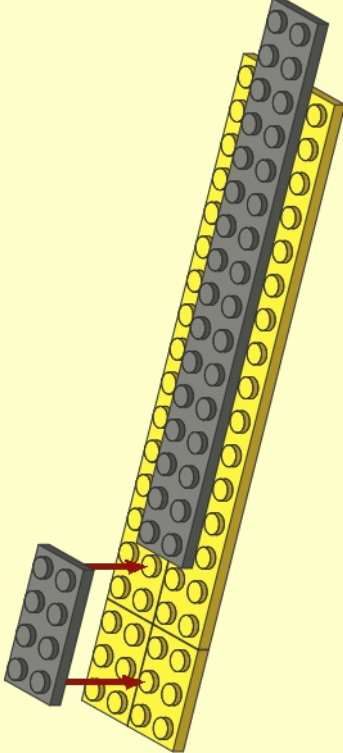
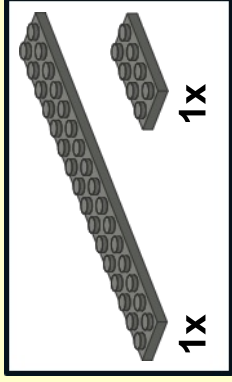

3

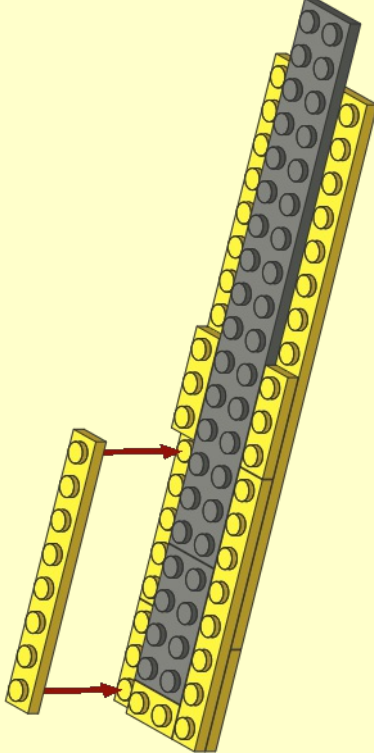
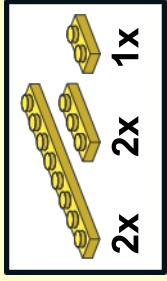

4

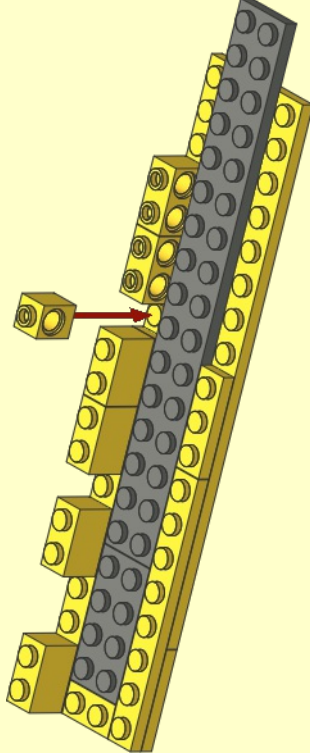

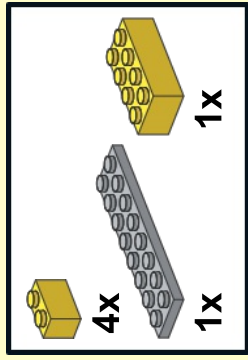

5



6



7

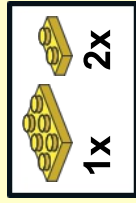

8

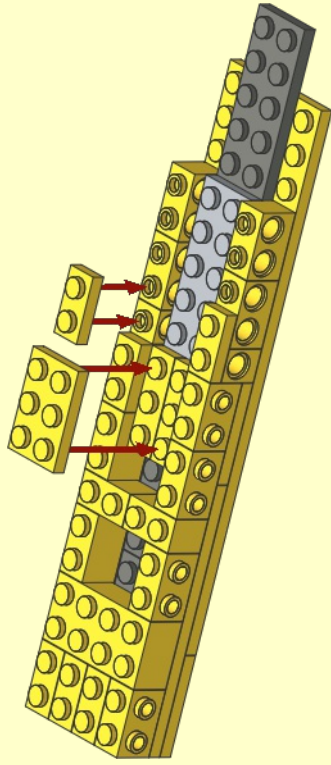
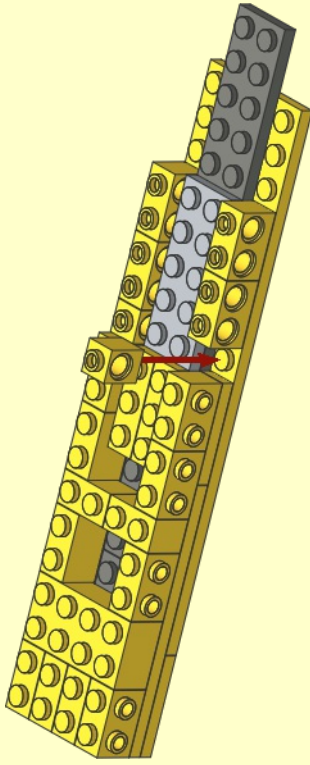
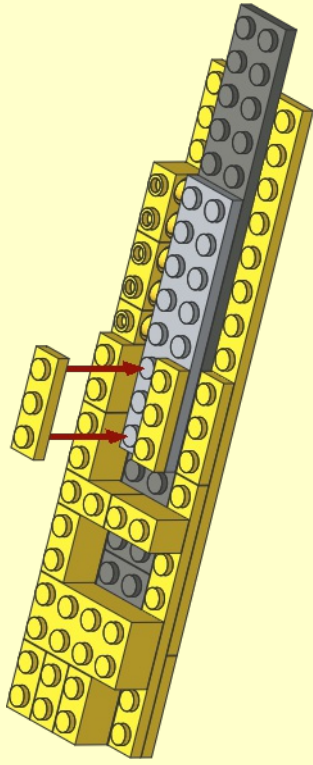
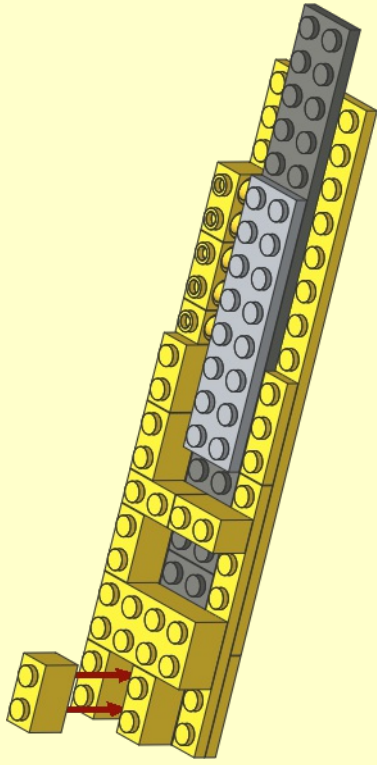



9

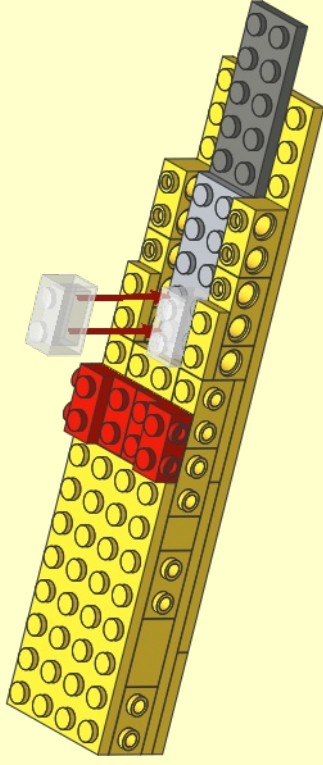
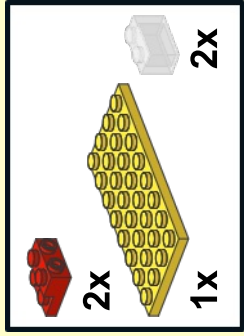

10

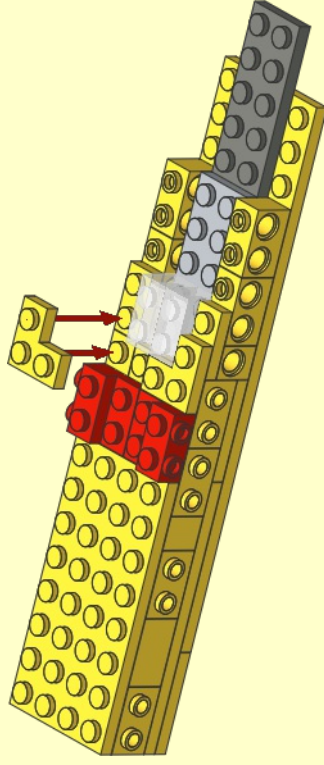

11

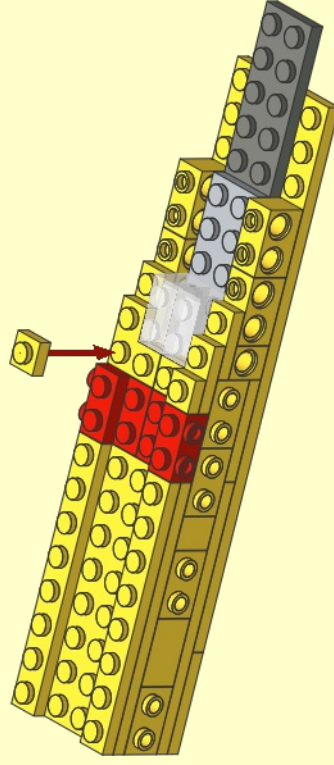
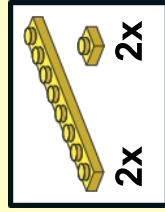

12

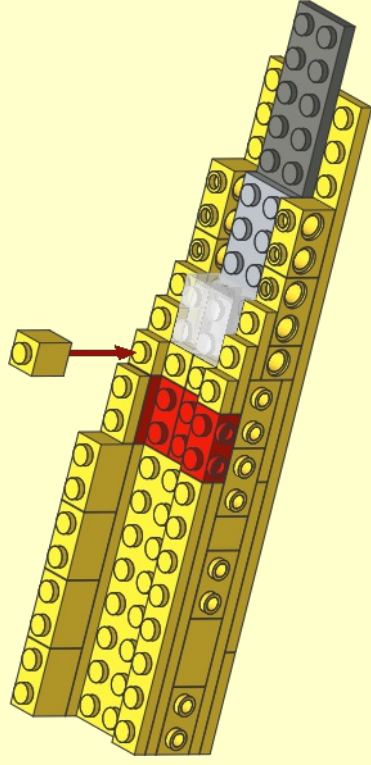

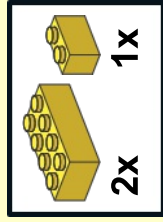

13

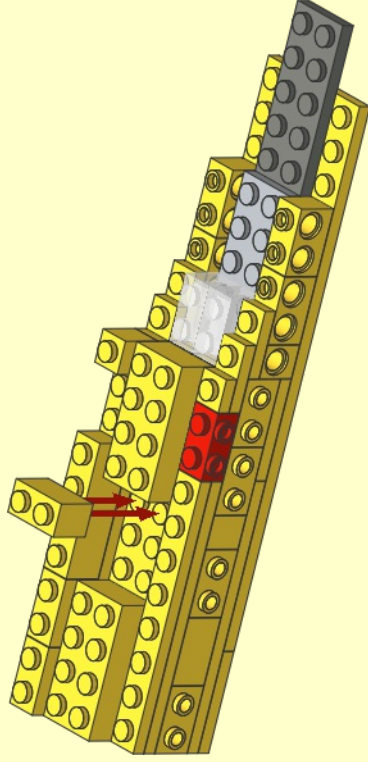

14

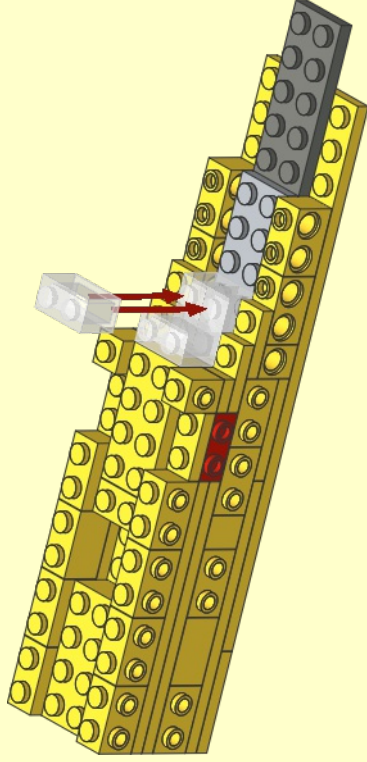

15

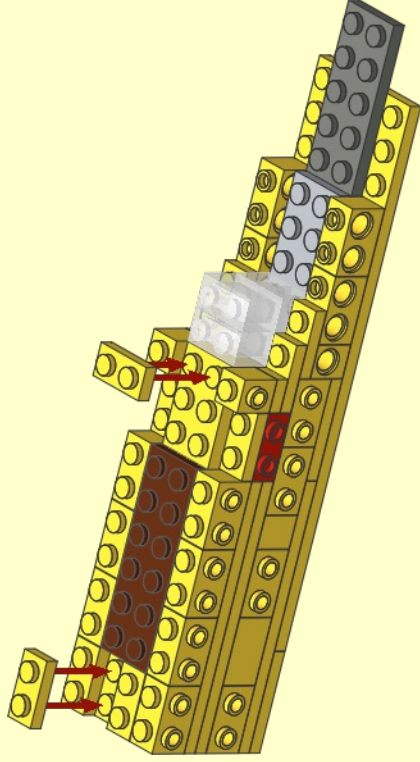

16

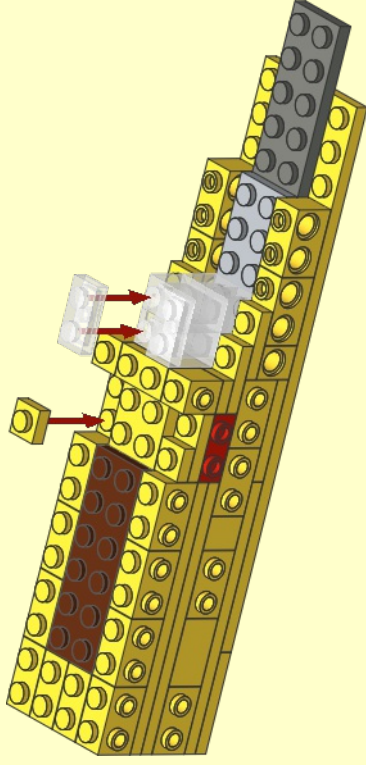

17

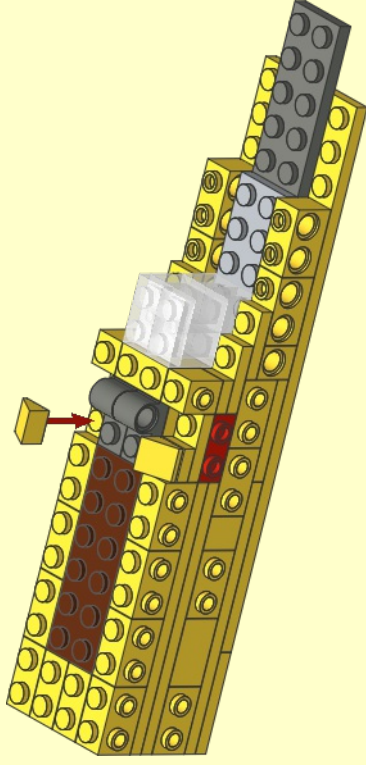

18

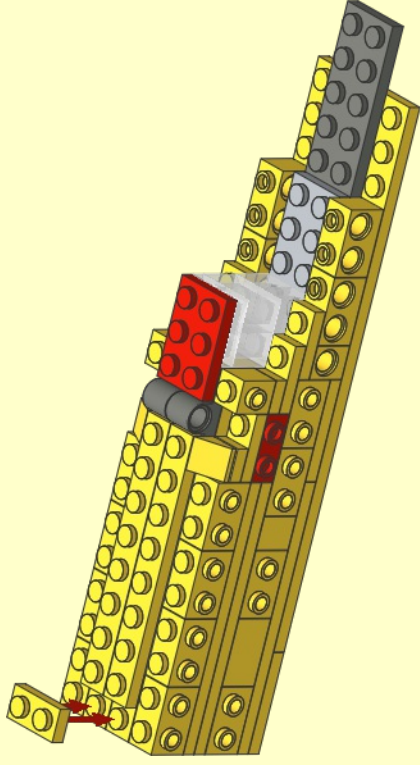
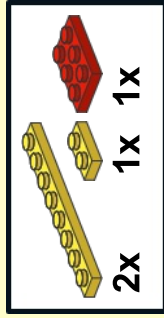



19

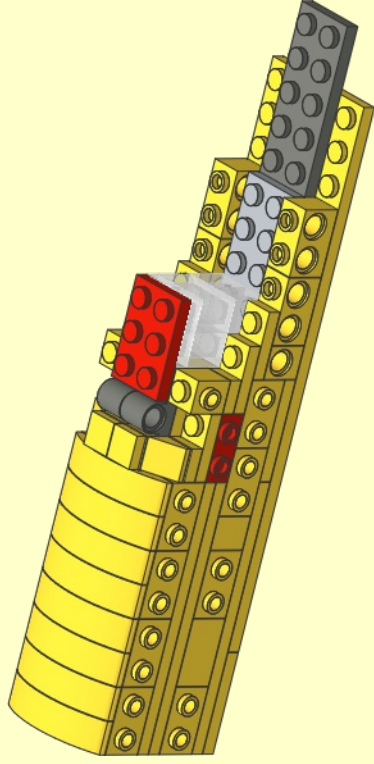

20

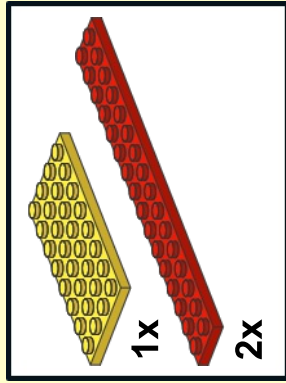
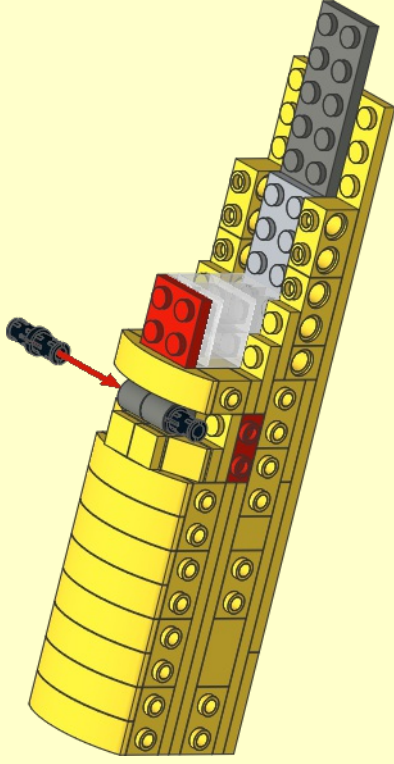

21

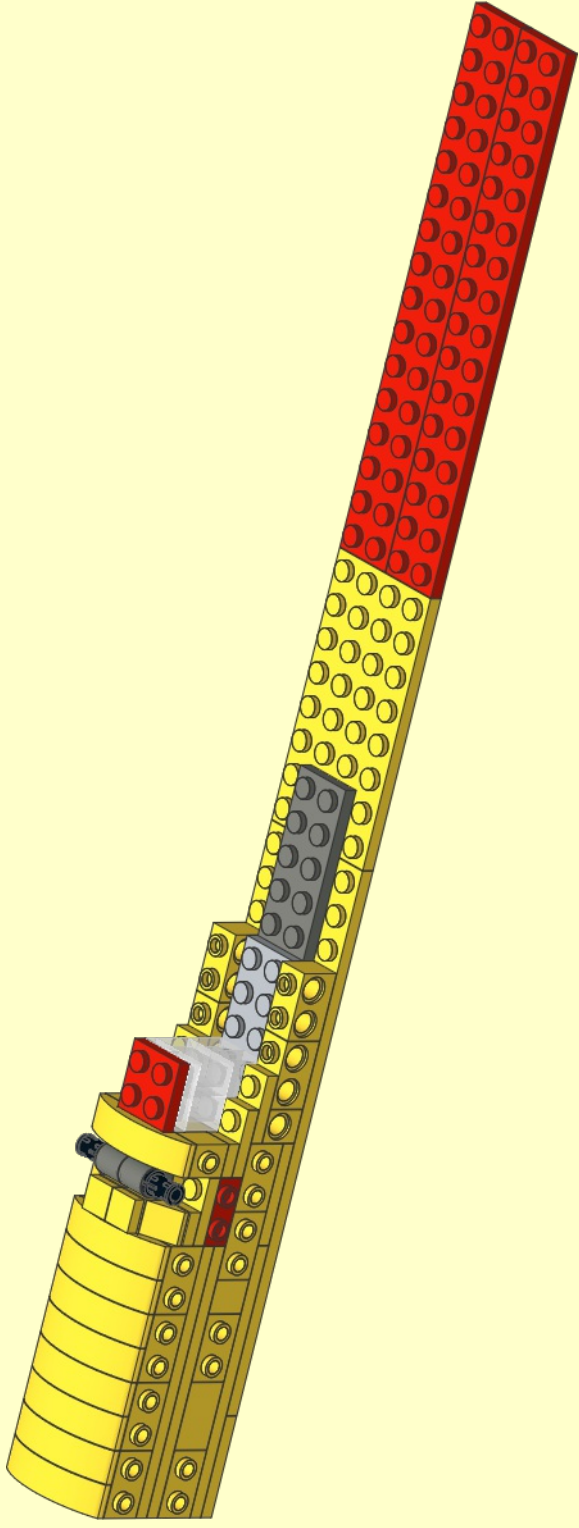

22

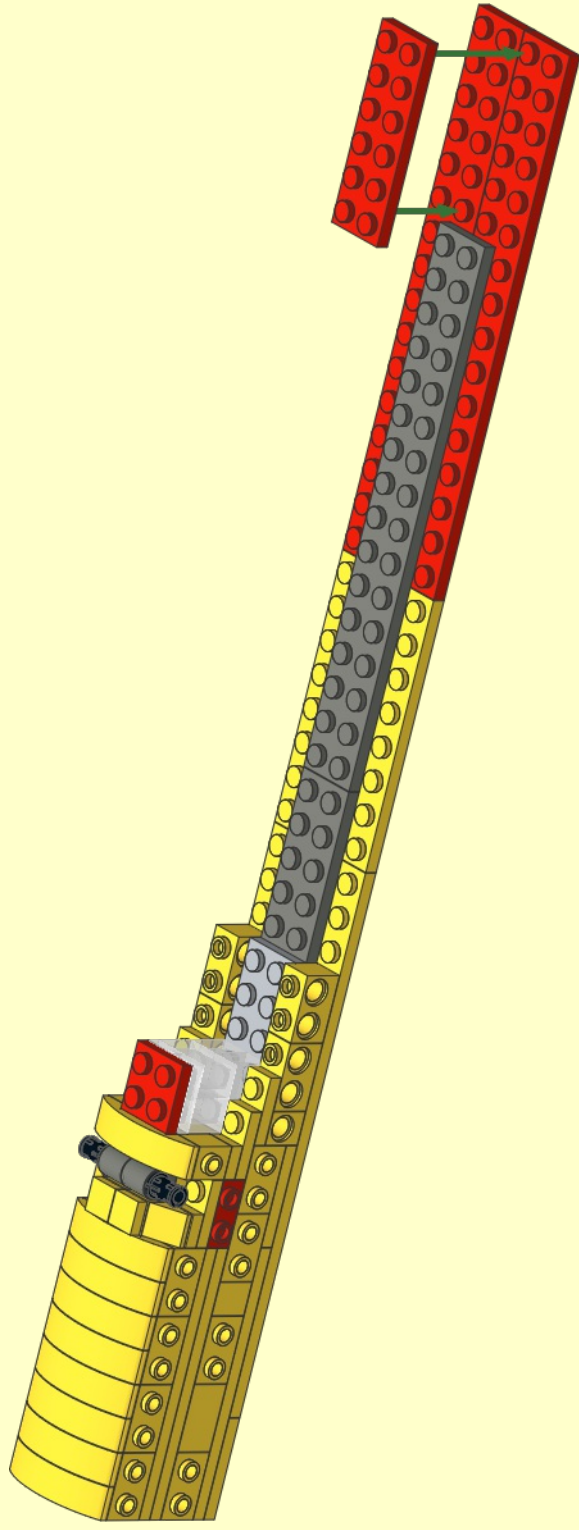
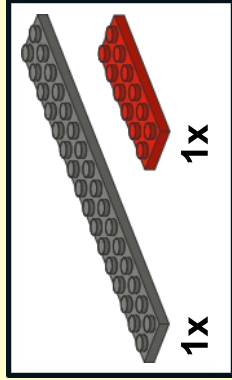

23

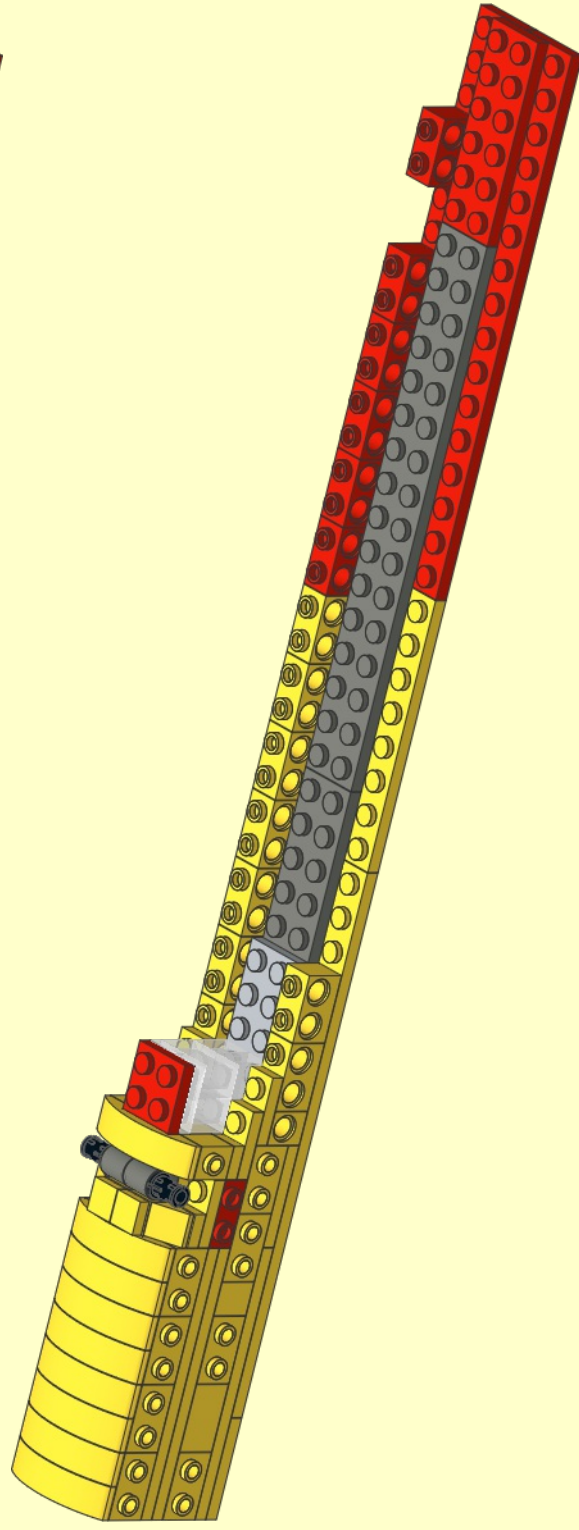

24

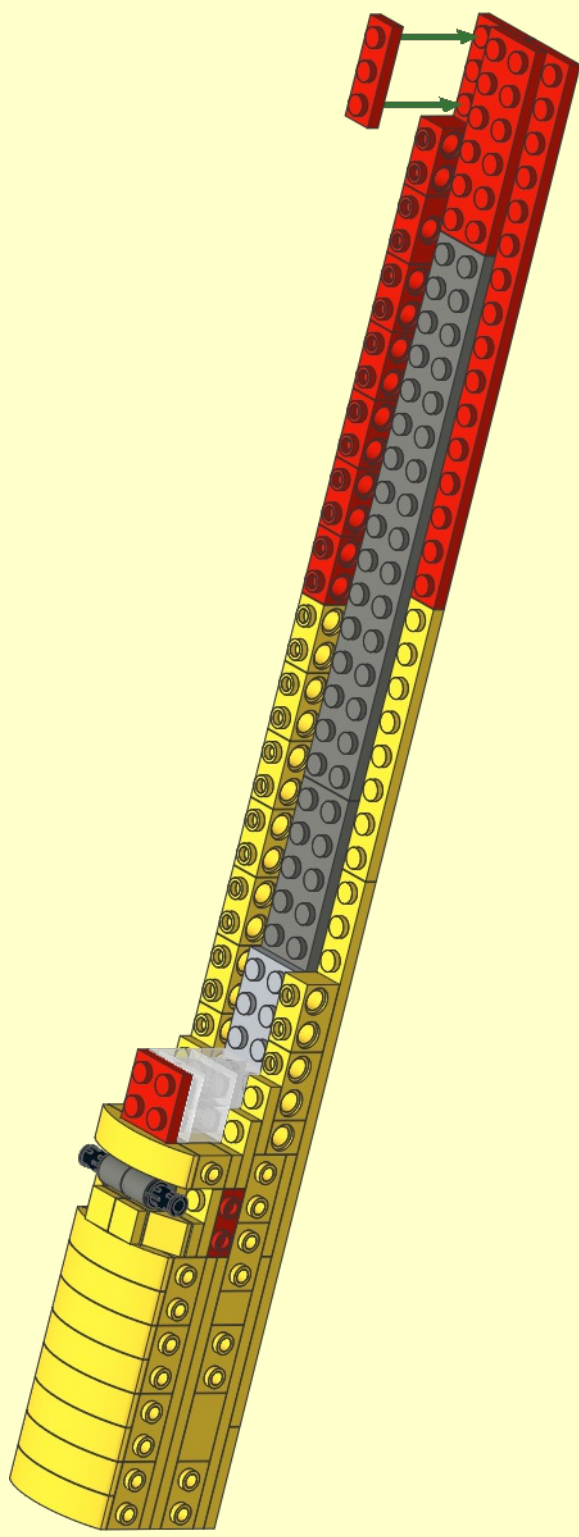

25

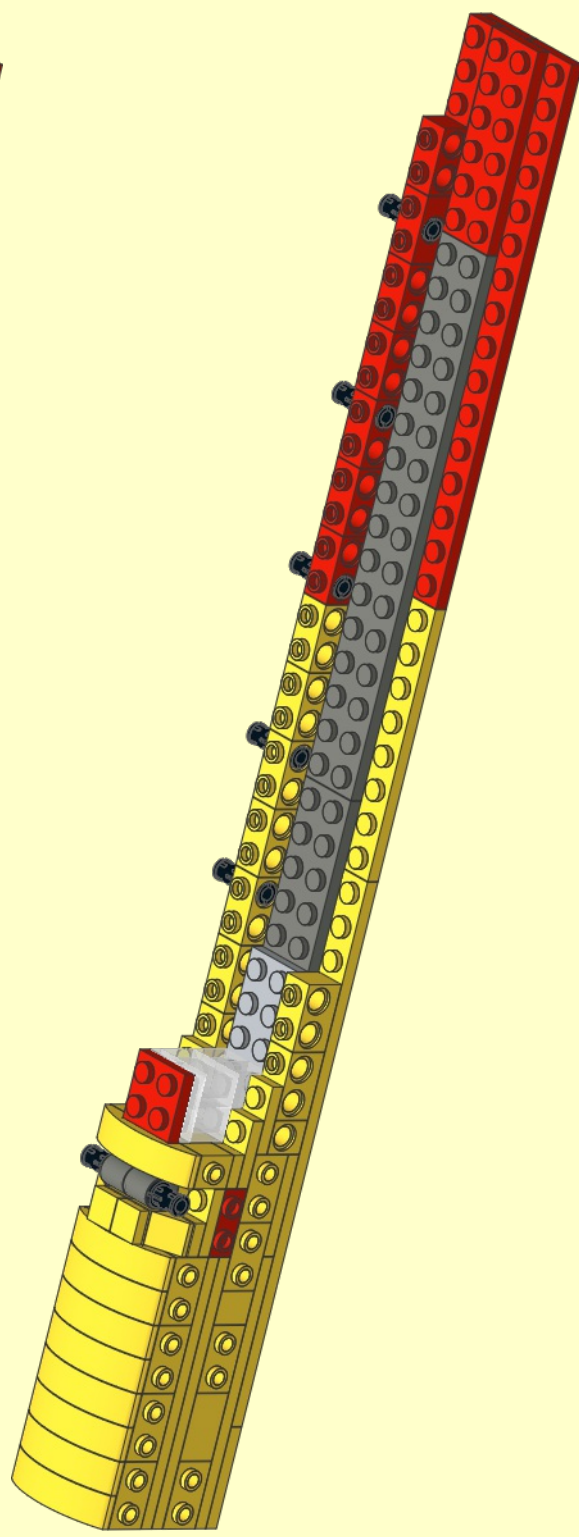

26

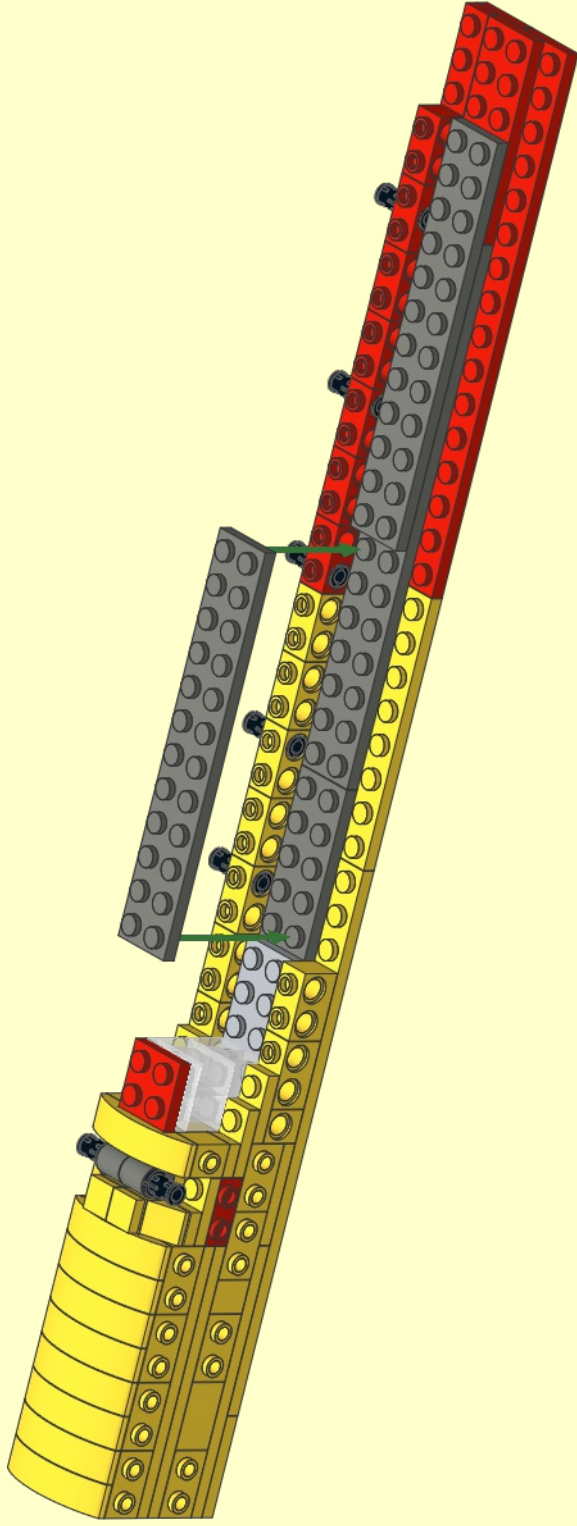
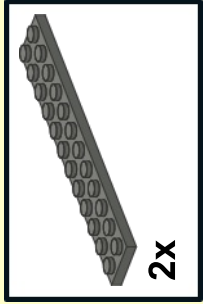

27

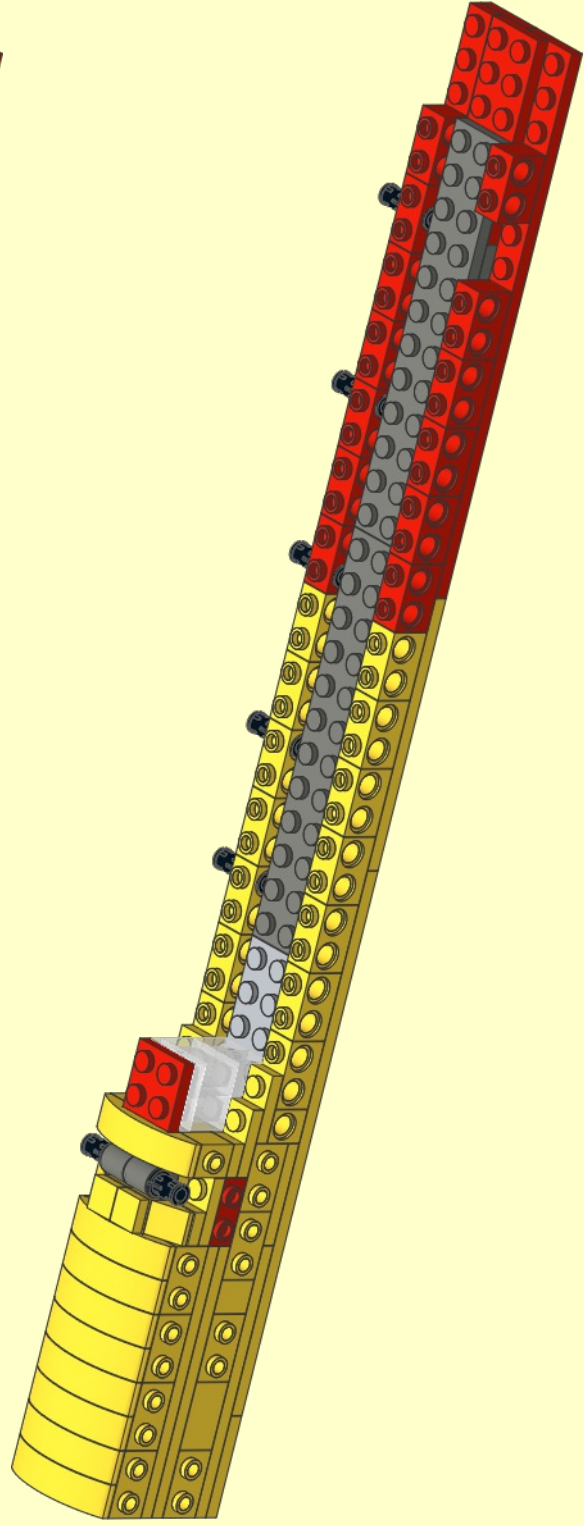

28

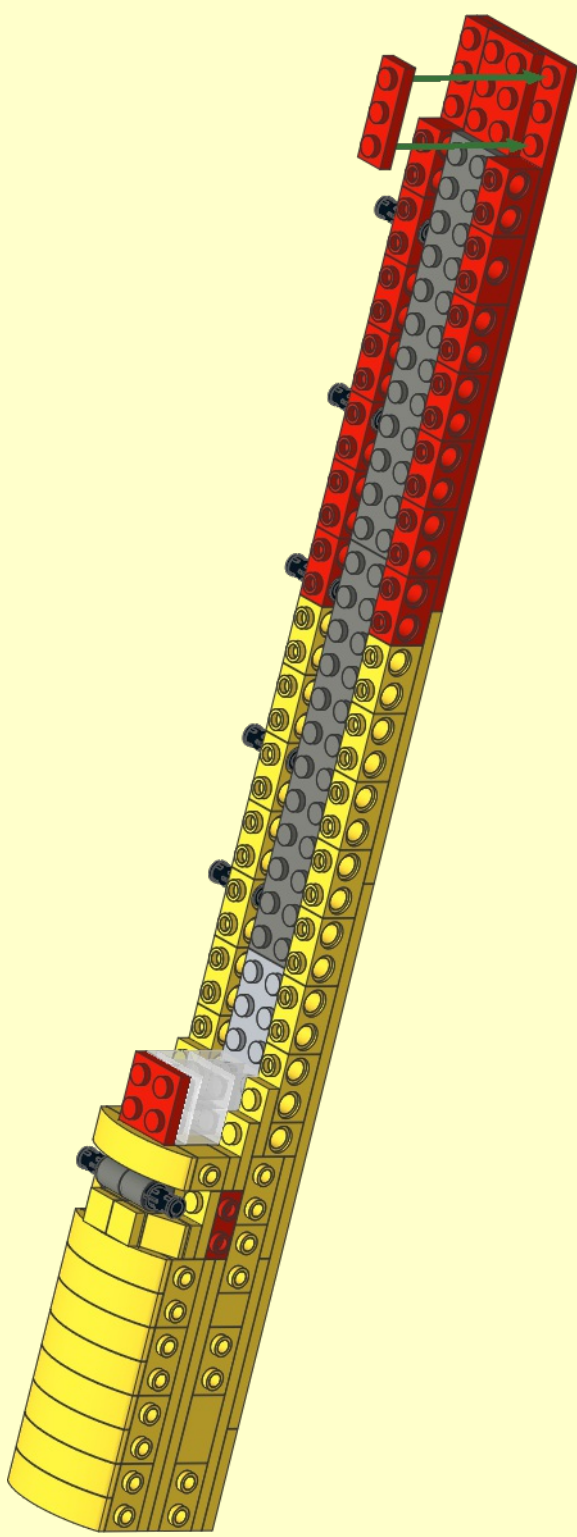

29

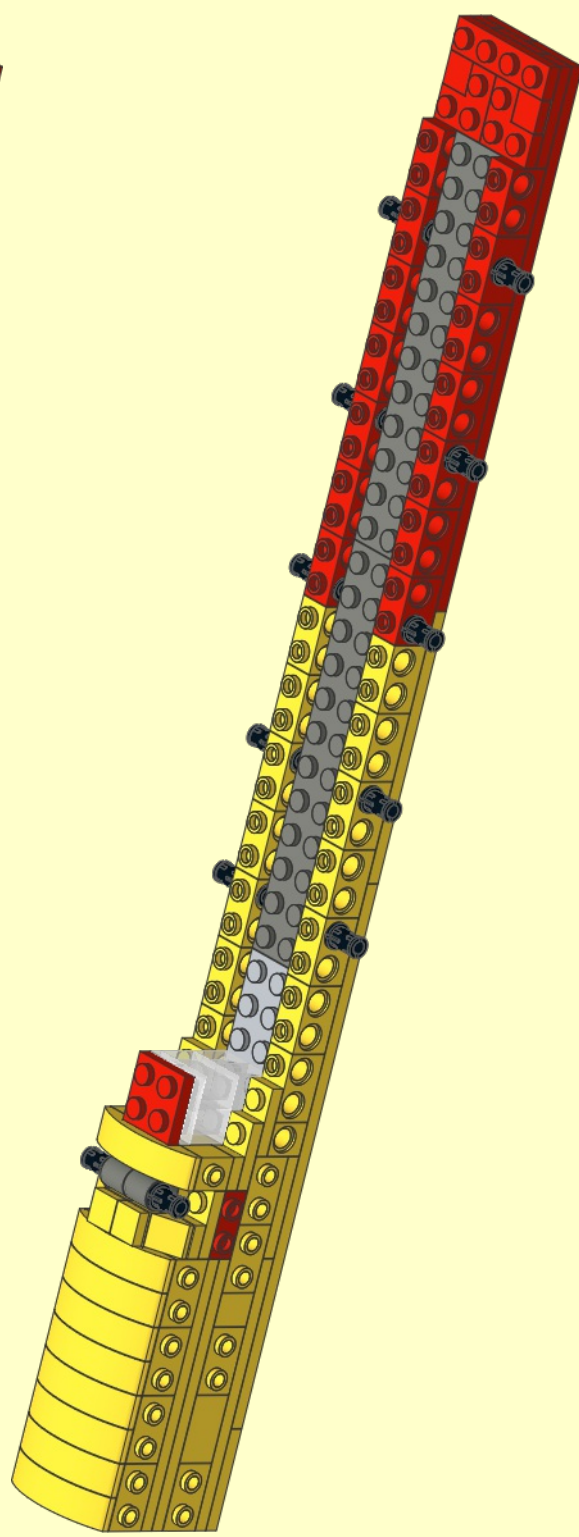
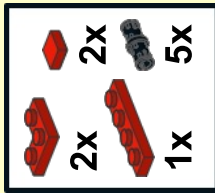



30

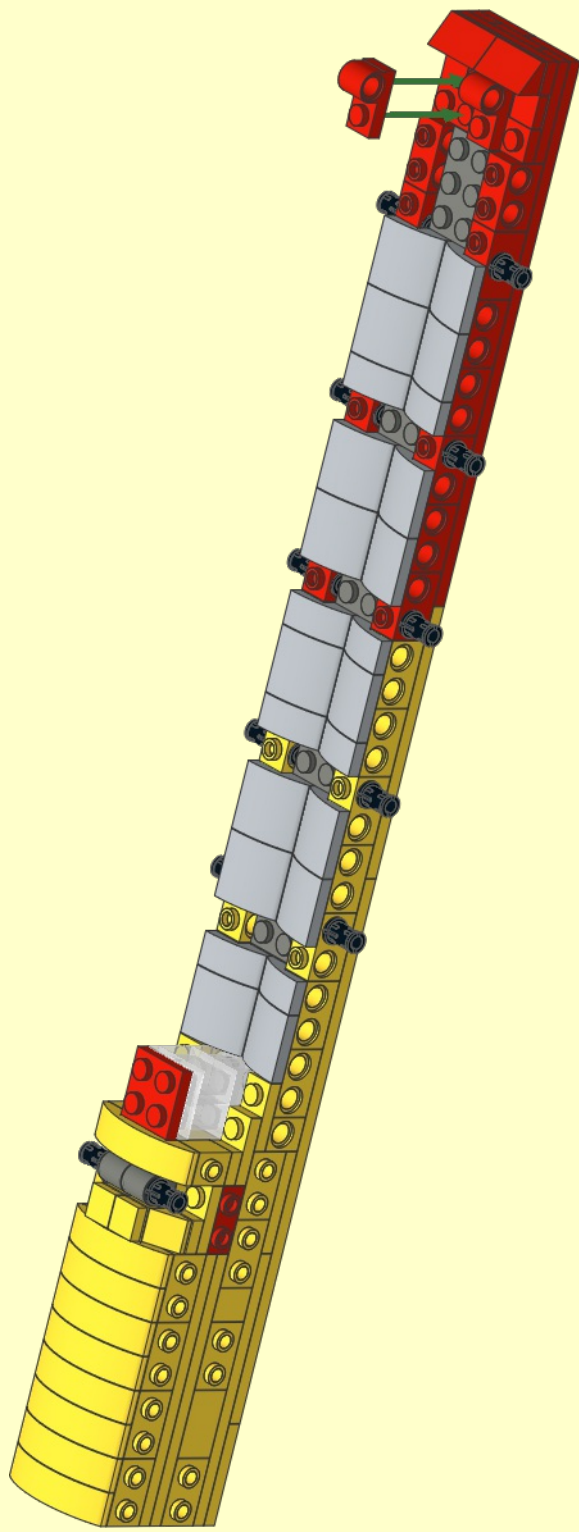

31

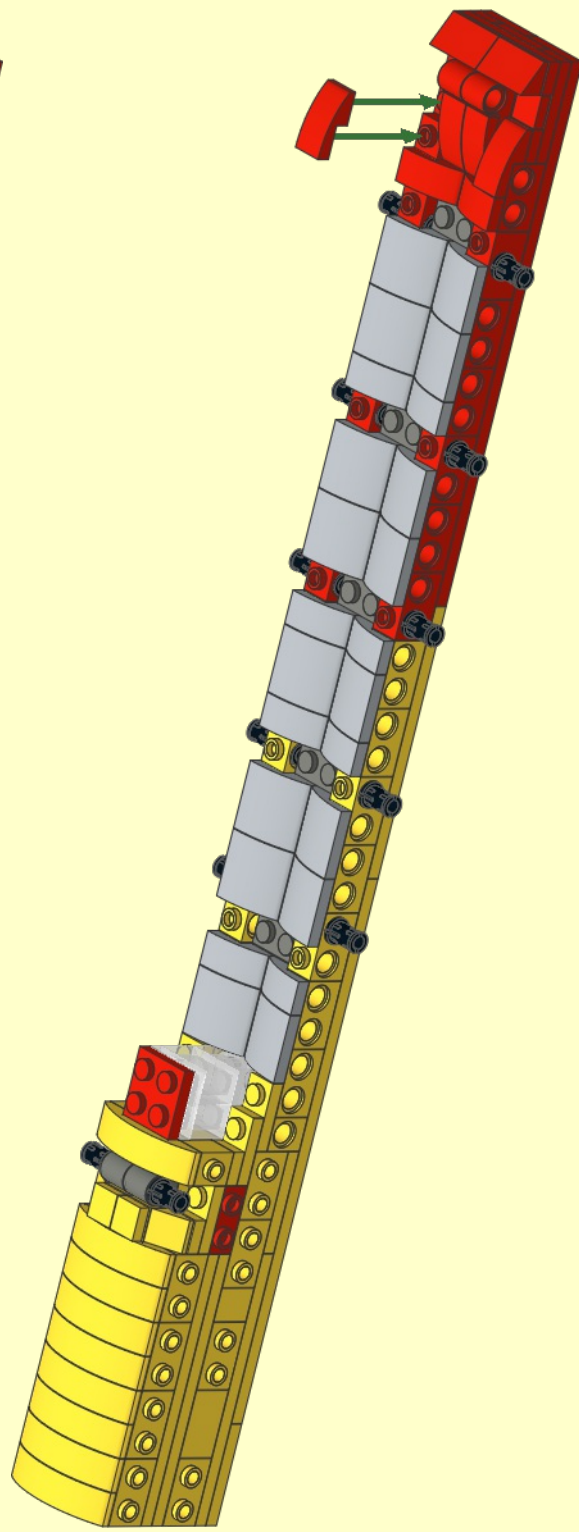

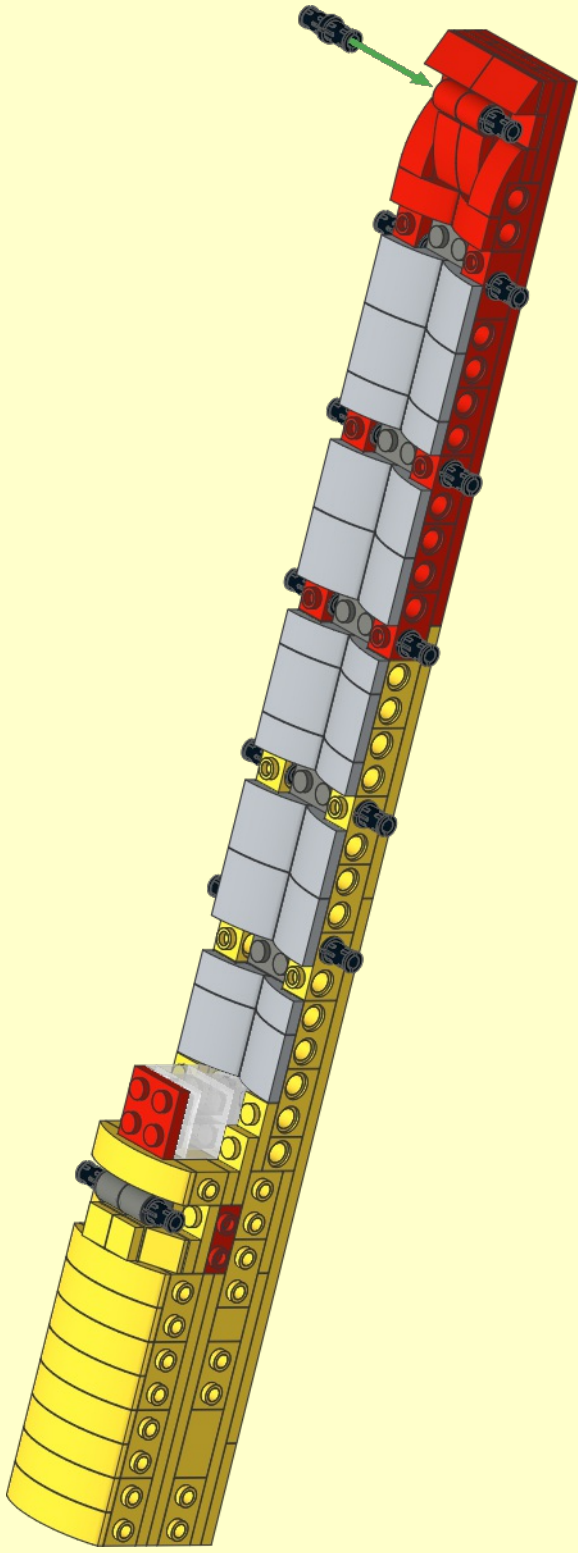

32

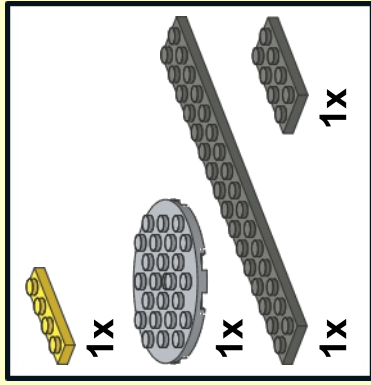
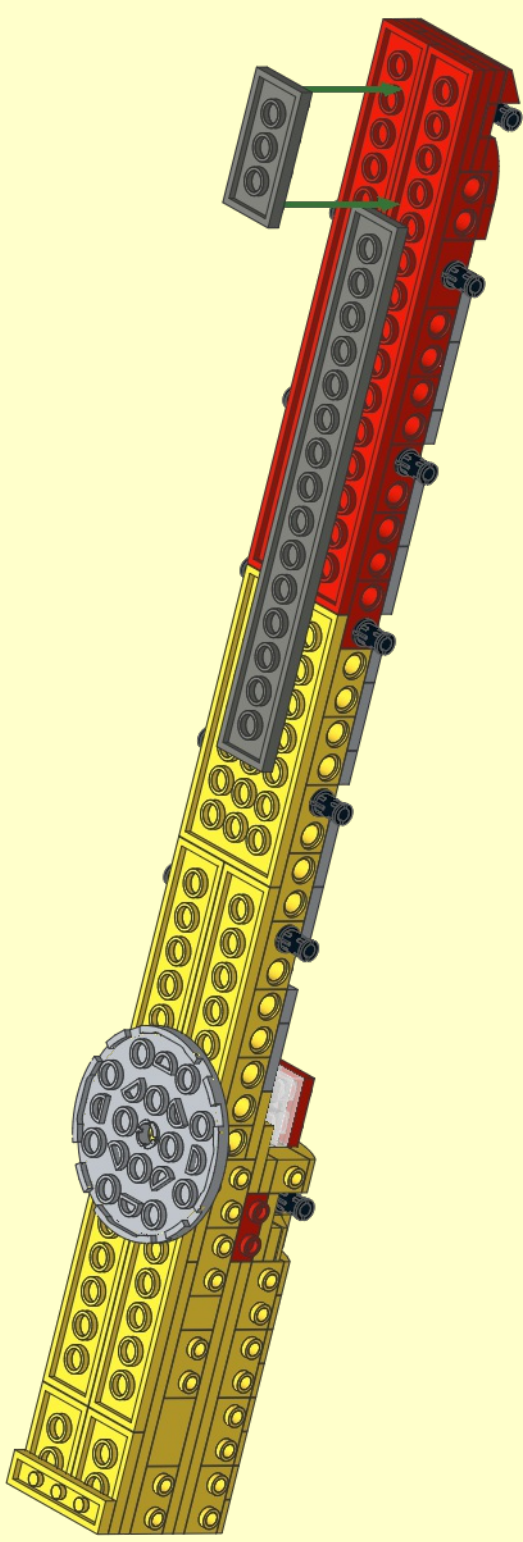

33

# 34

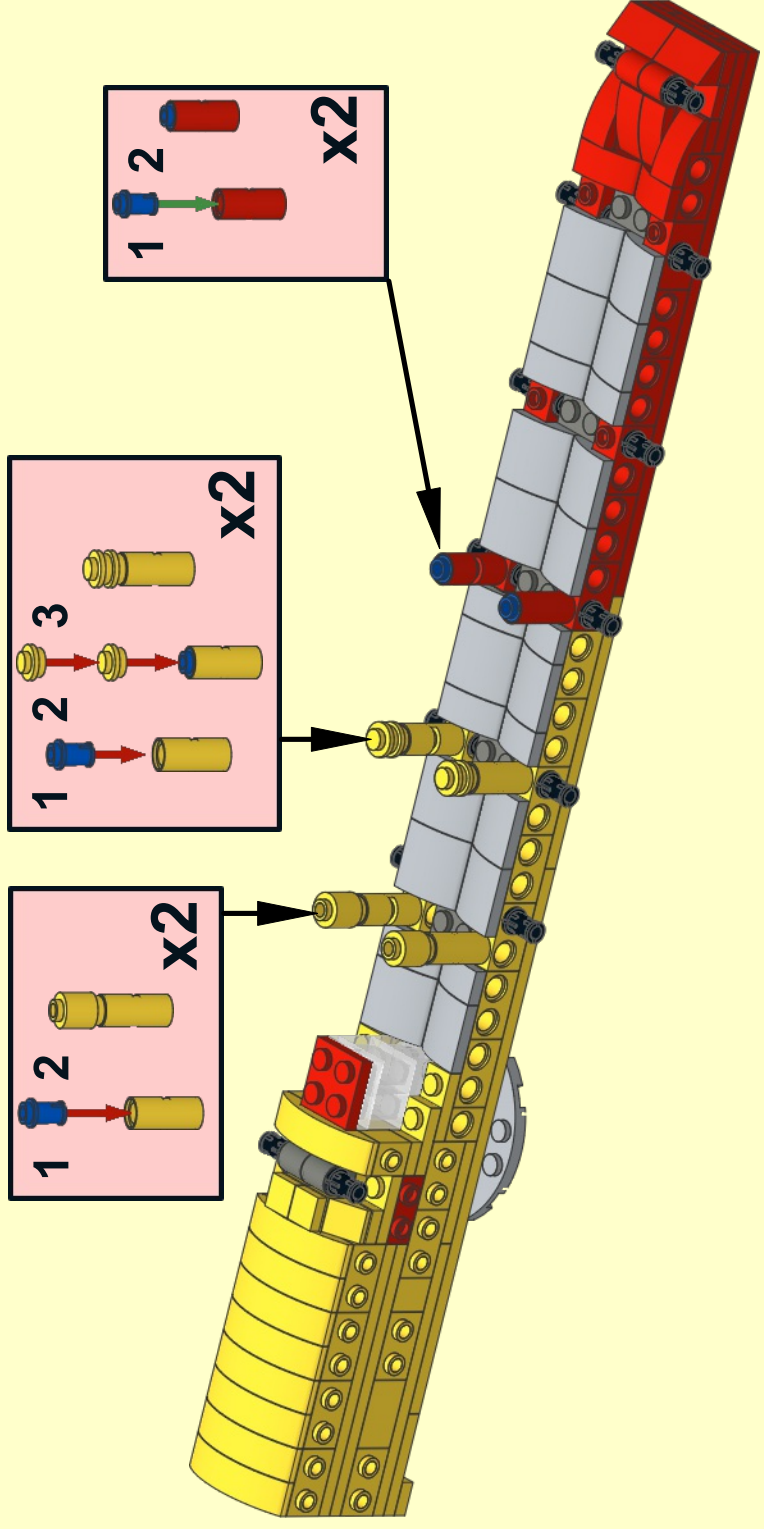

# 35

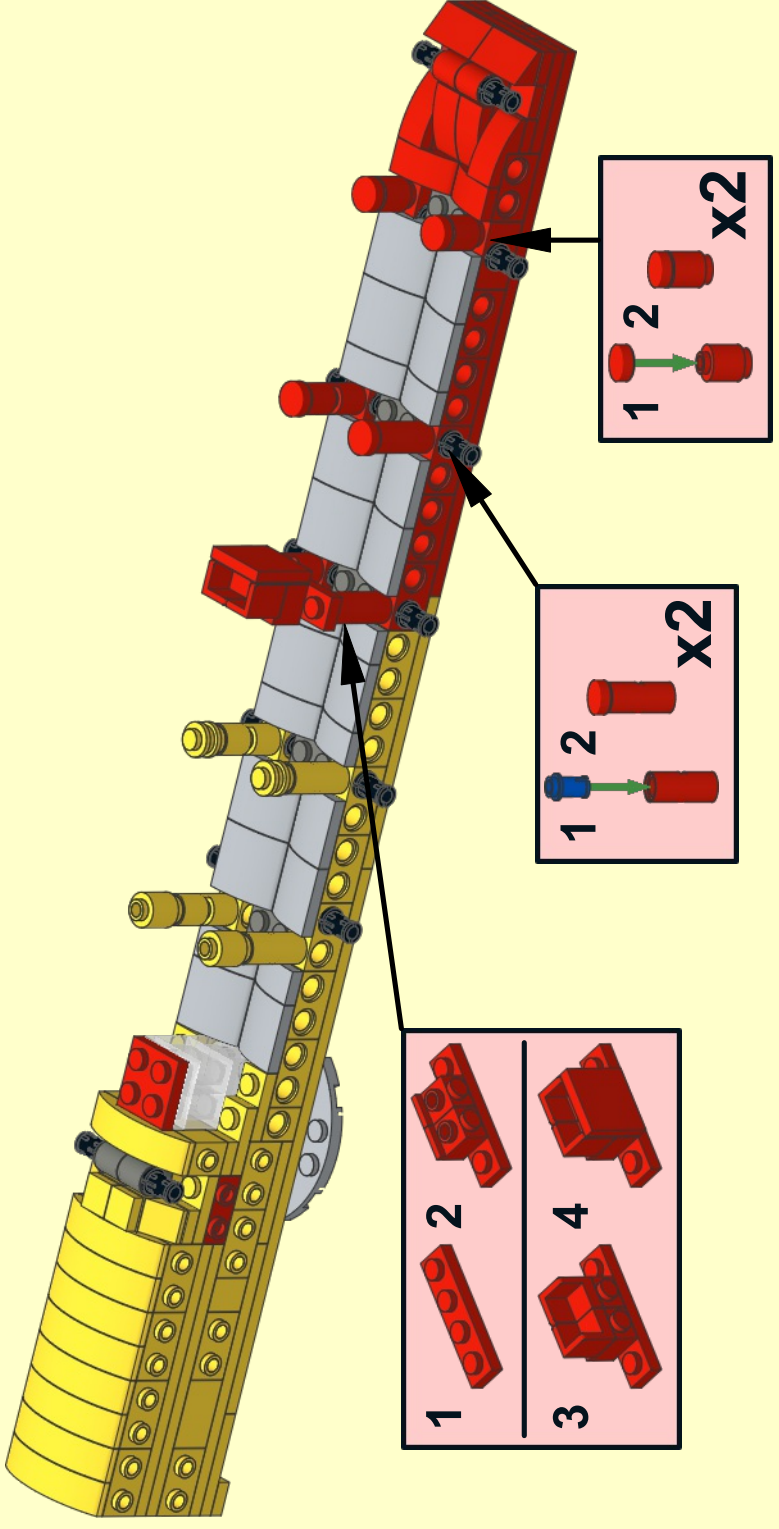
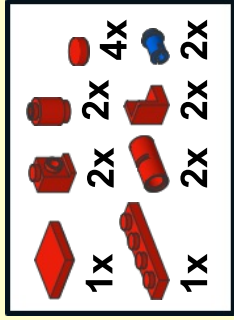

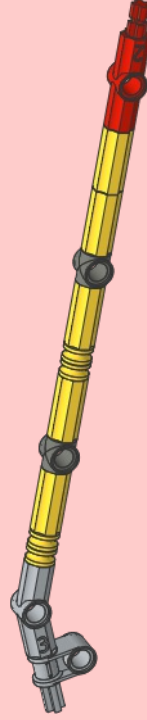
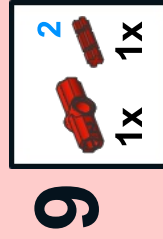
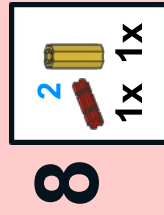
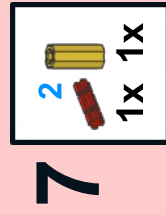
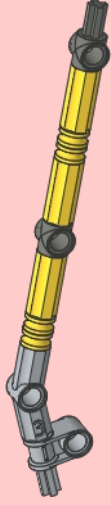
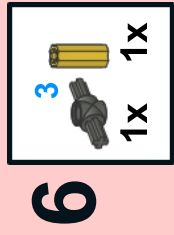
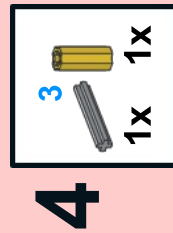
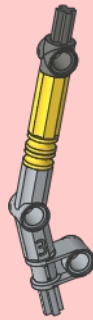
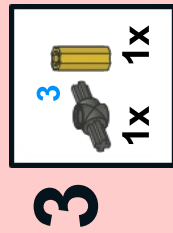



10

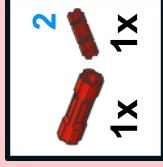

11

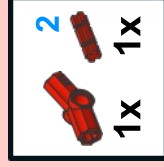

12

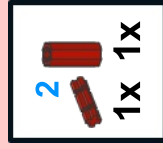
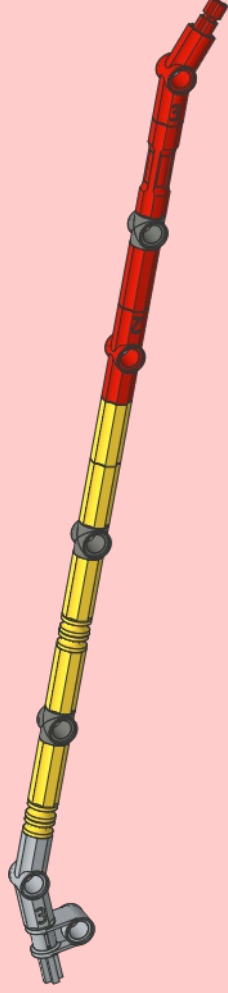

13

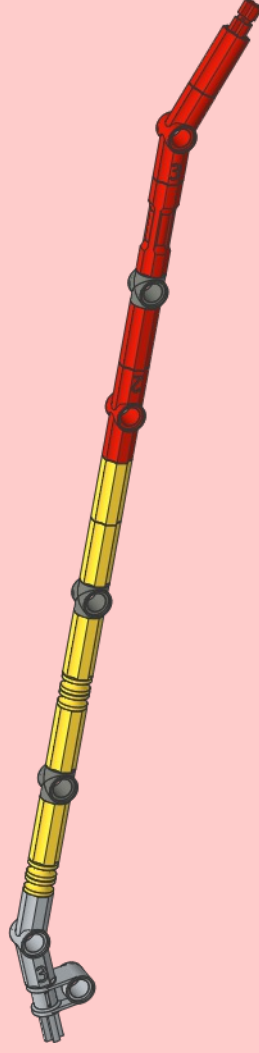

14

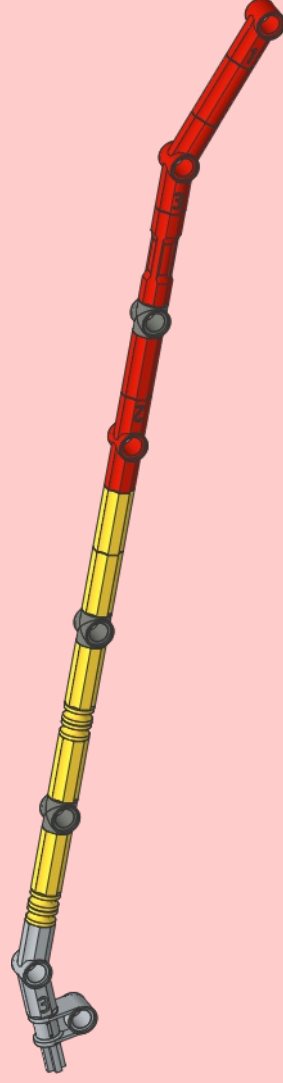

36

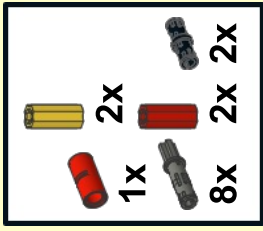
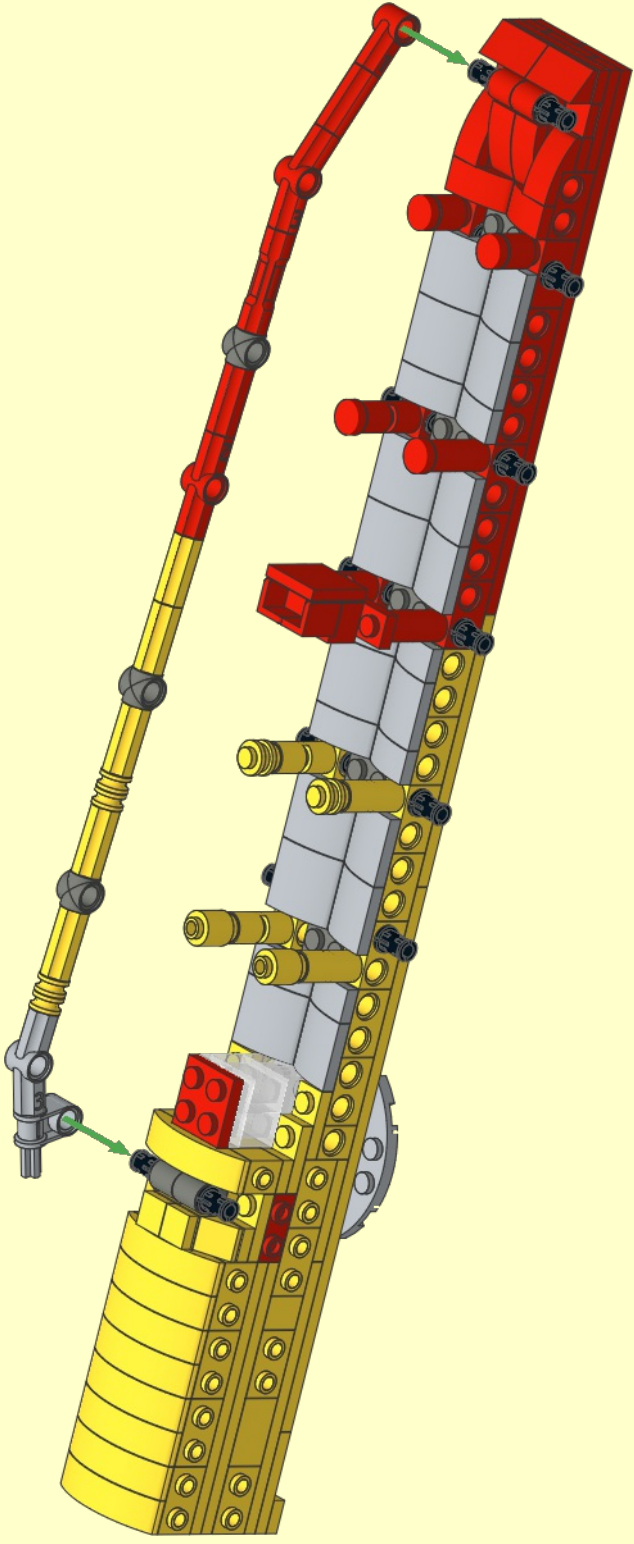

37

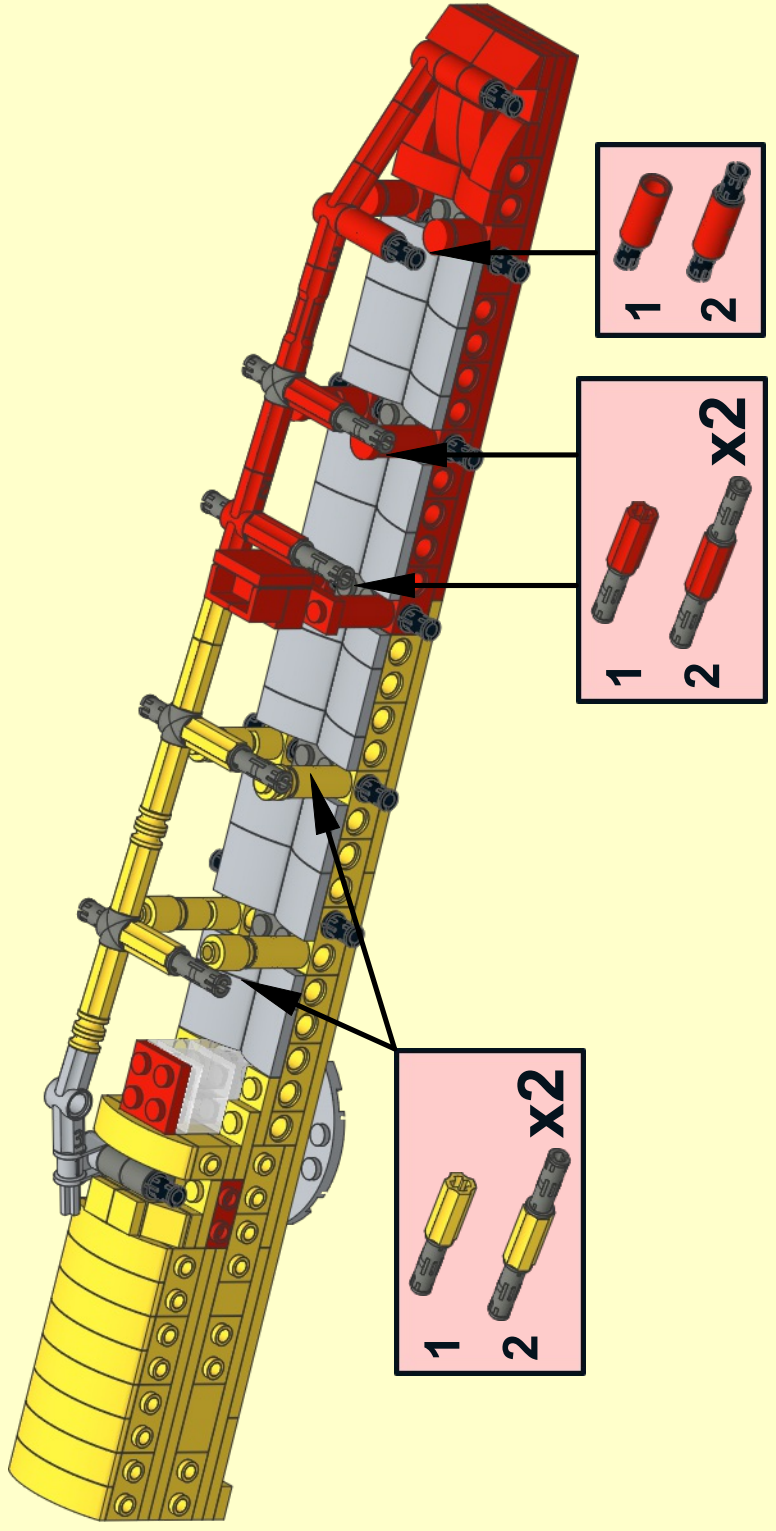

38

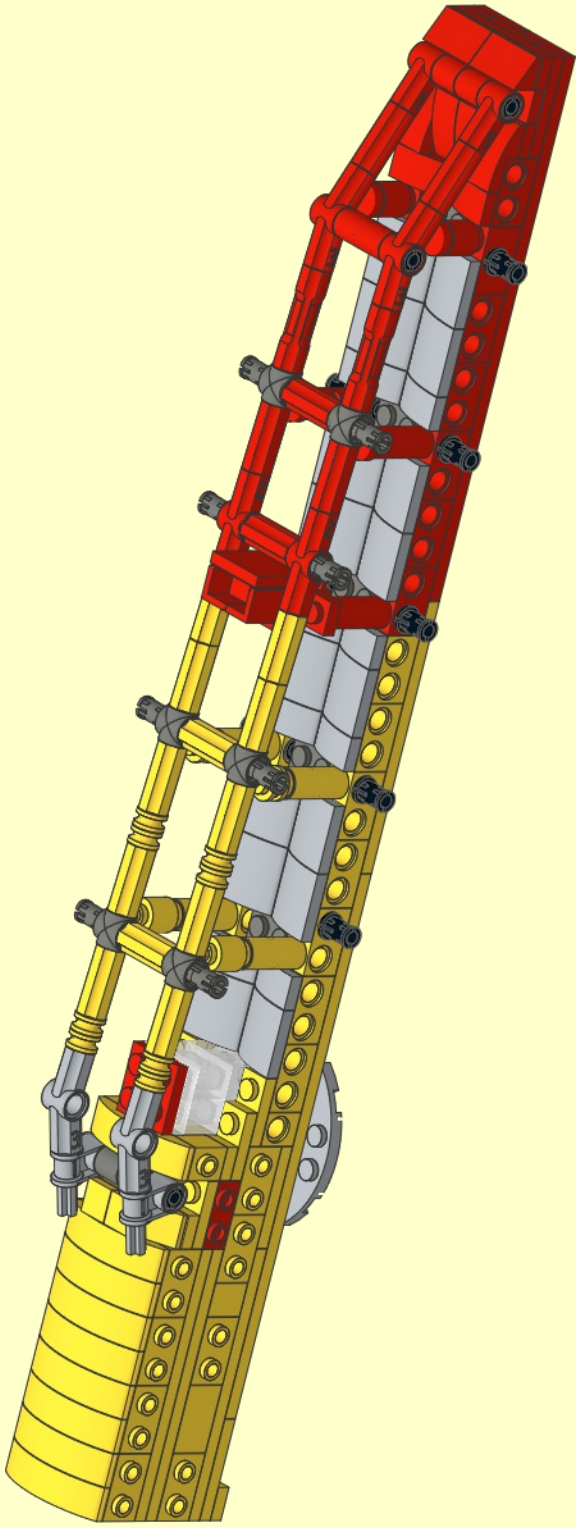

39

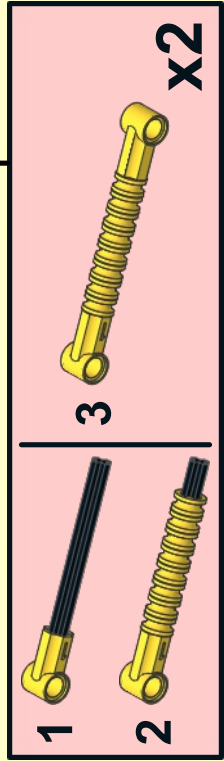
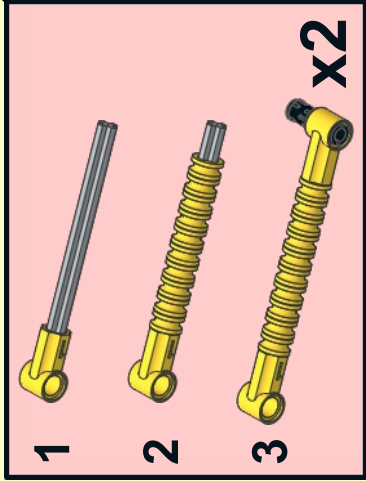
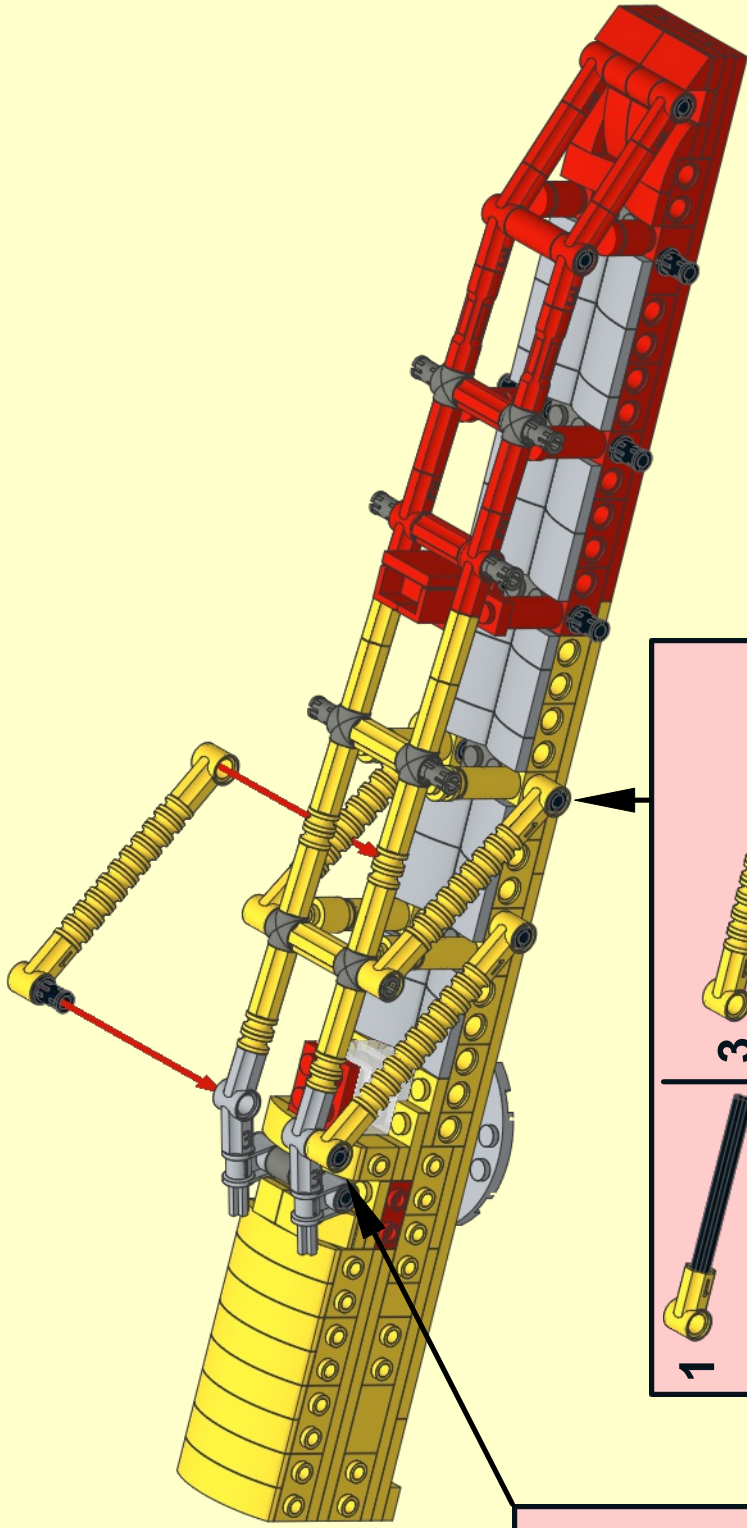
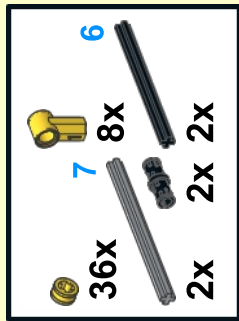

40

- 2x
- 2
- 5
- 8x
- 2x
- 8x
- 12x
- 2x
- 4x

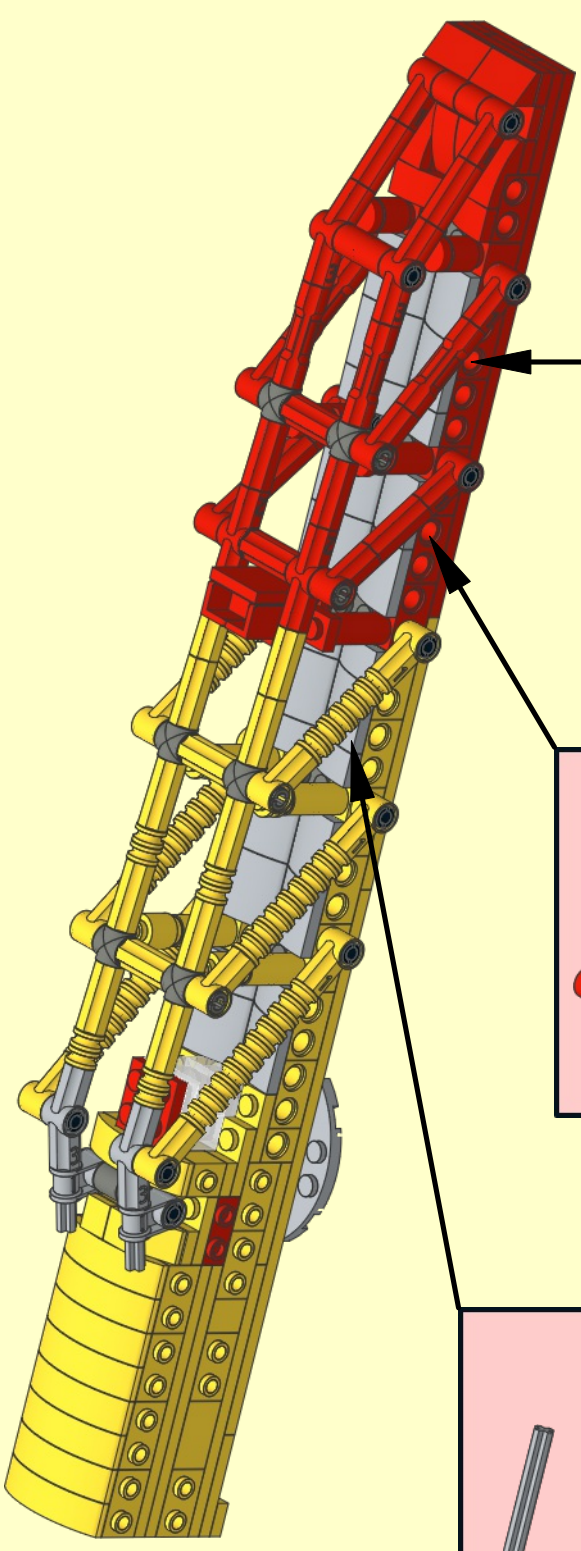

- 1
- 2
- 3
- x2

- 1
- 2
- 3
- x2

- 1
- 2
- 3
- x2

41

- 1x
- 1x

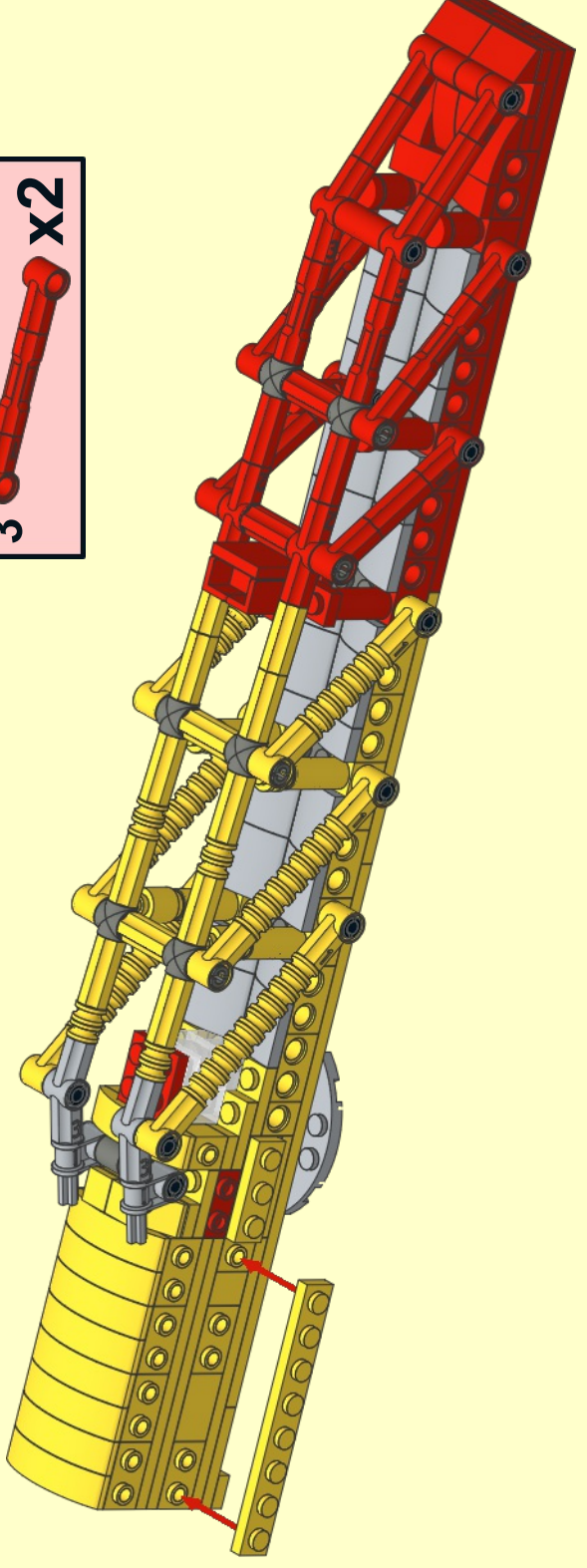





42

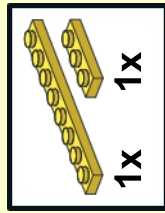
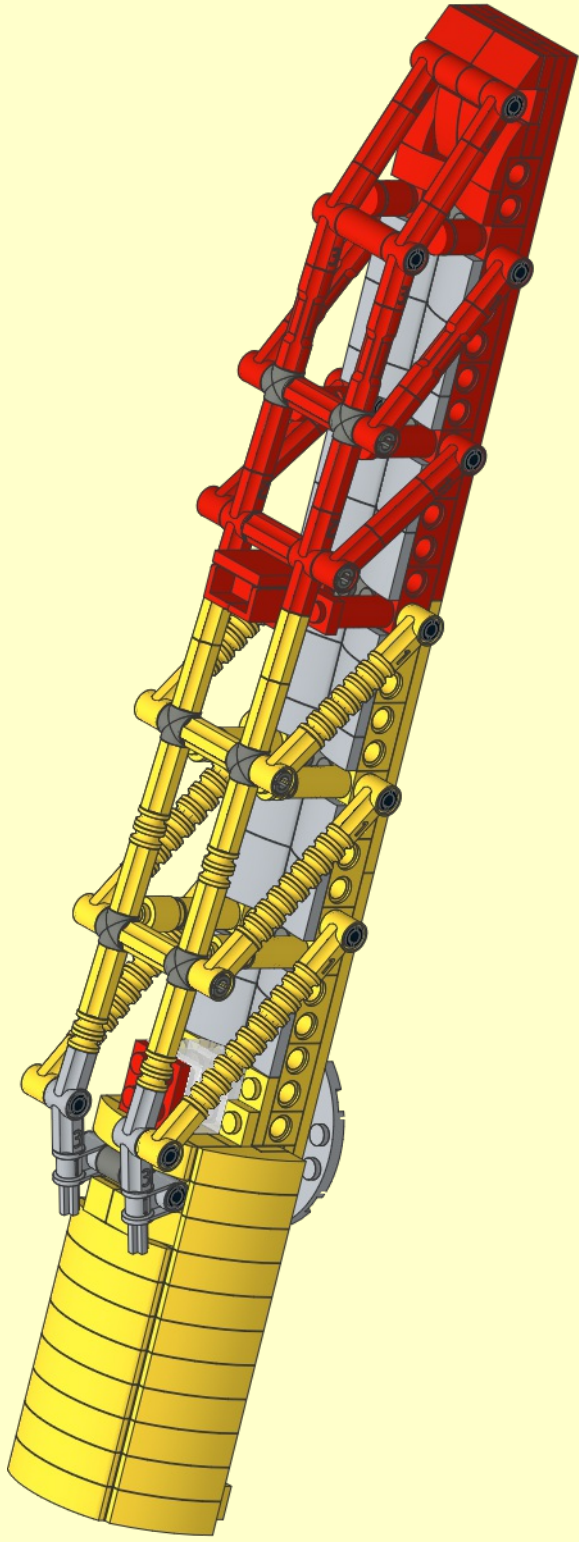

43

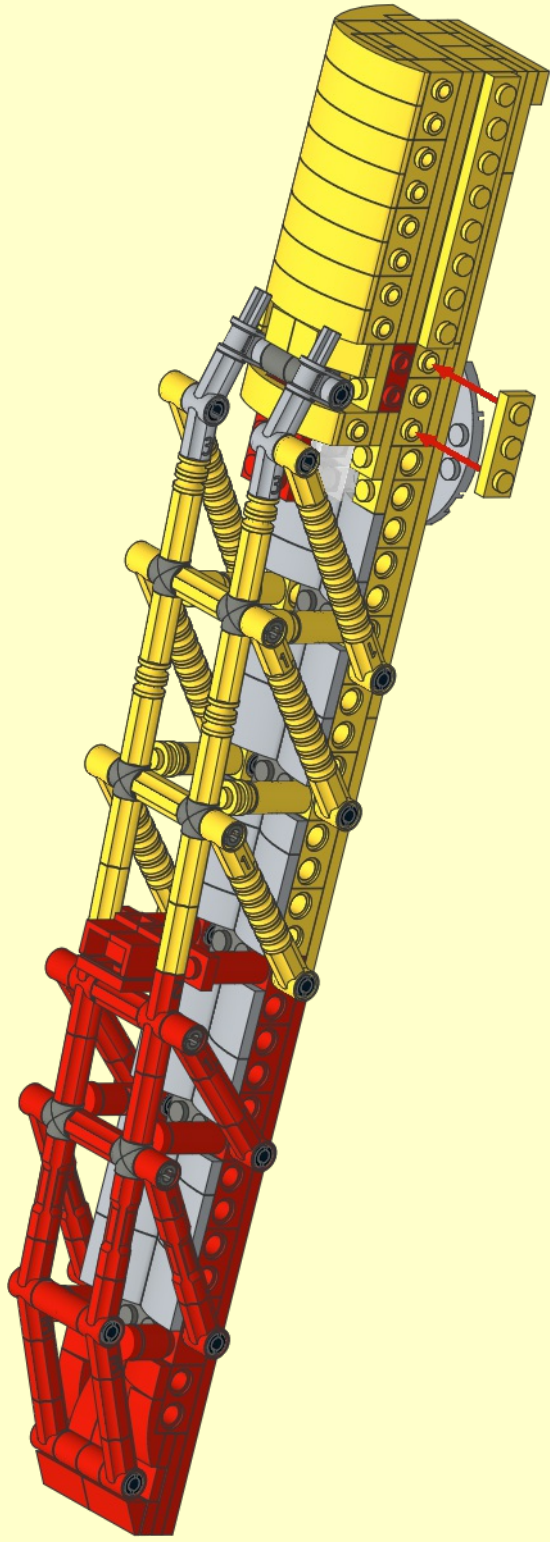

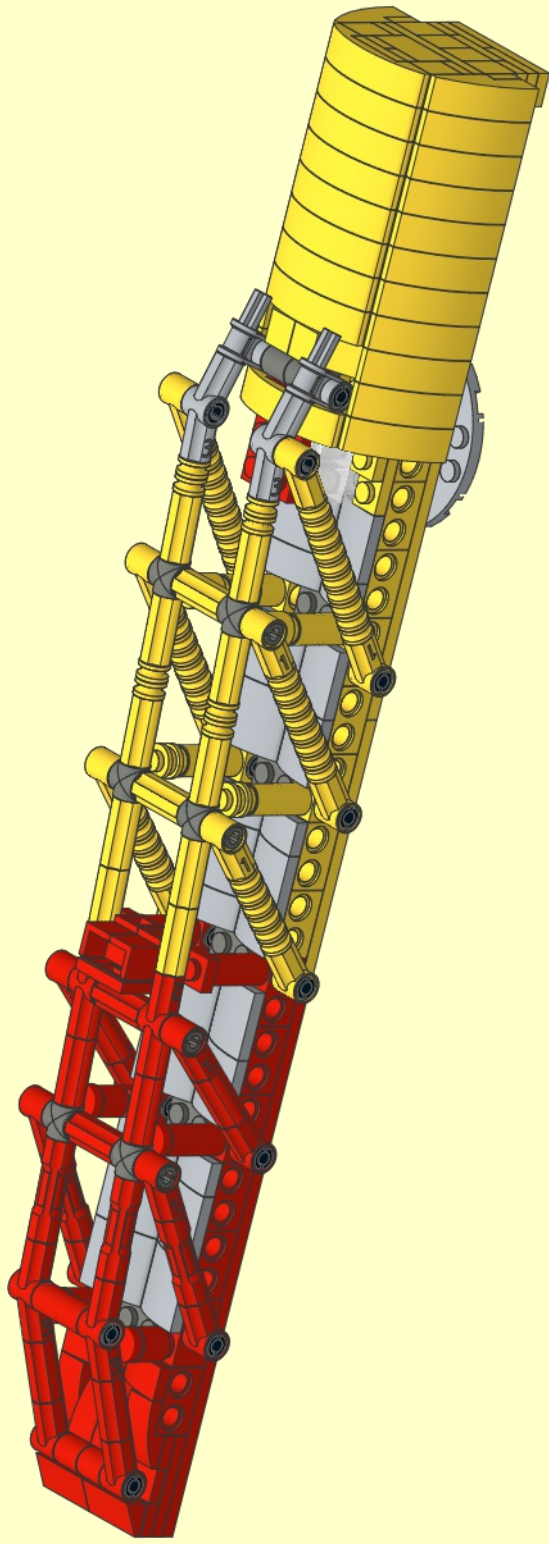

44

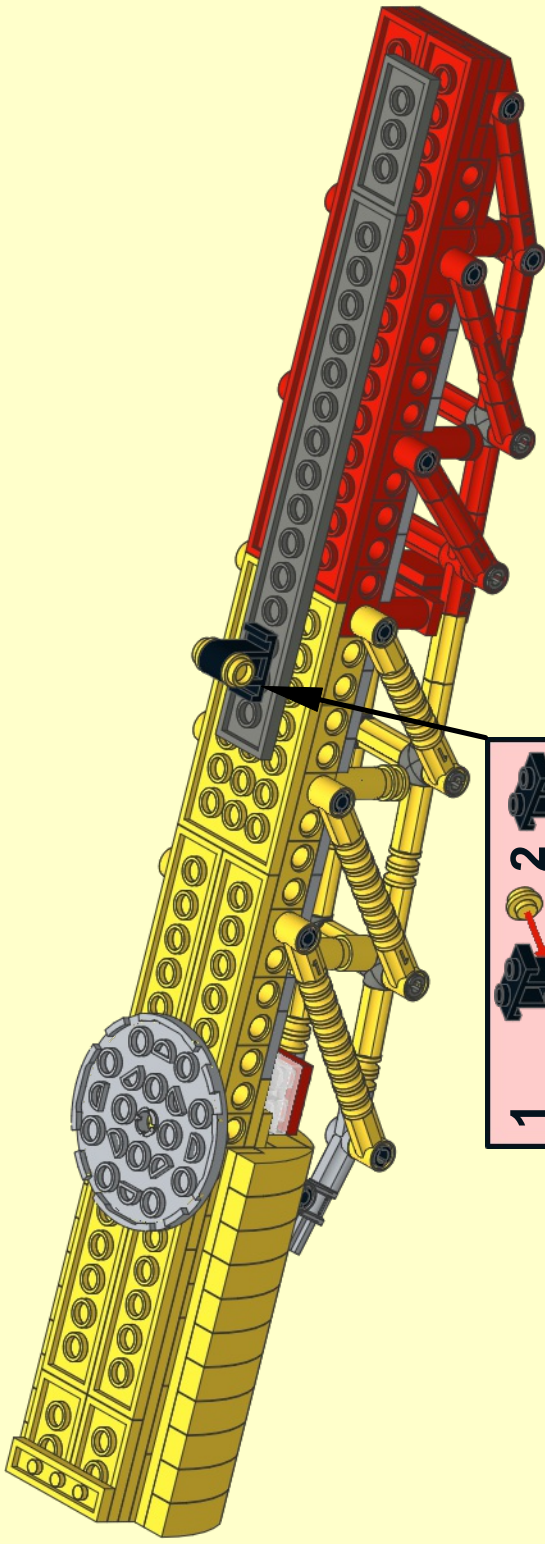

45

