

# Bricks in Space

Volume III: The Launch Umbilical Tower  
Part I



AMETRIA VERLAG  
Berlin, Berlin, Germany

[www.ametria.org/lego](http://www.ametria.org/lego)

Wolfram Broszies (ed.): Bricks in Space, Volume III: The LUT, First Edition, Berlin 2020

The text of this book is available under the licence GPL 3.0—<http://www.gnu.org/licenses/gpl-3.0.html>

Images used are, unless otherwise noted, in the public domain and might have different licensing arrangements, please refer to the copyright holders for details.

The instructions in this book are copyright by their respective creators.

Lego is a trademark of LEGO Denmark. This book is not associated with LEGO in any form, other than using their products for recreational and educational purposes.

Cover Image: High-angle view at Launch Complex 39, Kennedy Space Center (KSC), showing the Apollo 12 space vehicle leaving the Vehicle Assembly Building (VAB) on the way to Pad A. Sept. 8, 1969. Credit: NASA

First Published 2020.



# Bricks in Space

Modelling Spaceflight with Lego

Volume III: The Launch Umbilical Tower— Part I

Edited by Wolfram Broszies

First Edition, 2020





Dedicated to the kind men and women of the Kennedy Space Center Vistors Center





# Contents

Introduction .....	IX
Acknowledgements .....	XIII
The Apollo/Saturn Mobile Launcher.....	15
The Bailey Fullarton LUT .....	23
The Roche-Cremer LUT .....	25
The Michael Cameron LUT .....	27
The Joseph Chambers LUT .....	29
The Nathan Readioff LUT.....	31
Launch Umbilical Tower Instructions Part I.....	32
References.....	206





# Introduction

All modern rockets, even those not bound for space, require some support before and during launch. Only a fraction of that support is in service of the payload – for mounting a manned spaceship a simple ladder would suffice. In reality, things are much more complicated, most of all because rockets are incredibly complicated machines, requiring high levels of monitoring and care.

On a very basic level, the rocket needs to be uprighted and kept from toppling over, which is no easy task considering that the Saturn V weighs as much as a destroyer when her fuel tanks are full. So if the rocket does not arrive erect at its launch place already – like, let's say, the Saturn V on the Crawler – then it has to be moved into an upright position at the launch place, which requires gantries and cranes and lots of machinery.



A V2 getting ready for launch.  
Credit: NASA



Nov. 14, 1969 - Personnel within Firing Room 2 of the Launch Control Center follow the early moments of the Apollo 12 launch on their overhead data display boards.  
Credit: NASA

Most larger rockets use liquid fuels of some kind, and most of them like hydrogen or methane have to be stored at extreme cold temperatures, lest they boil and evaporate. And since rocket designers care about every kilogram that is not fuel or payload, the insulation of rockets has to be as minimal as possible. Most of the rocket fuel will be burned within the first minutes of flight anyway, so it makes sense to fill the rocket's tanks as close to launch as possible and save on the insulation. Fueling directly at the launch site requires more support of course – tanks, pipes, pumps, valves and the like.

And then there is the issue of control. Directing rockets to fly along the planned path, whether it's a specified orbit or a certain landing zone, requires lots of calculation. Every second the mass of the rocket changes due to burned fuel, and every second the thrust of the engines meets with less air resistance as the rocket rises through the atmosphere, all while Earth's rotational speed, wind, air pressure and countless other factors make the flight path complicated.



The Crew Access Arm for a new generation of spacecraft was lifted into place the morning of Aug. 15 2017 at Space Launch Complex-41 where workers are modifying the launch pad to give astronauts access to Boeing's CST-100 Starliner on launch day.

Credit: NASA

Having such a complex system requires thousands of measurements, sensors, gauges, and control mechanisms that make sure that the rocket is indeed ready and fully functional before launch. For decades rocket launches drove the development of automated systems, computers and sensors. In the Sixties the Apollo program consumed roughly 60% of all electronic circuits available in the USA.

A launch pad combines these three functions to achieve one goal – making sure that passengers and payload are safe throughout countdown and flight. Even the first operational long-range rocket, the V2 - despite its relatively modest size - required a whole vehicle park and a complete company of soldiers to be fueled, aimed and fired correctly, Trucks loaded with propellant, tools, guidance and command cars, technicians and security all clustered in a complicated ballet around the “launch table” where the V2 came to rest after being offloaded from its transporting trailer. Launch preparations were shortened as much as possible to evade allied fighter patrols, yet it took usually more than an hour to get a single rocket ready to fire.

As rockets grew, so did their launch pads and the time rockets spent in launch preparation. Civilian rockets could be launched from permanent installation, which made the installation of tanks and fixtures possible. In the US, Cape Canaveral emerged as the main “space port” for two reasons: the Cape is relatively near to the equator compared to other U.S. locations, and it is on the East Coast.



The various launch complex' stretching along the coast of Cape Canaveral in the Sixties.

Credit: NASA

An East Coast location was desirable because any rockets leaving Earth's surface and traveling eastward get a boost from the Earth's spin. A West Coast location would either send rockets over populated areas or have to contend with launching against the direction of the spin. And the rate of spin is at its highest on the equator and slowest at the poles, so the Cape's southern location also gave it an extra boost compared to launch places in the North.



Liquid Oxygen, chilled down to more than minus 220 ° C, boils off a Falcon 9 while the rocket is fueled during launch preparations. January 17th, 2016

Credit: NASA

The Apollo program brought an tremendous amount of construction to Cape Canaveral, with dozens of launch pads, vehicle assembly buildings, crew



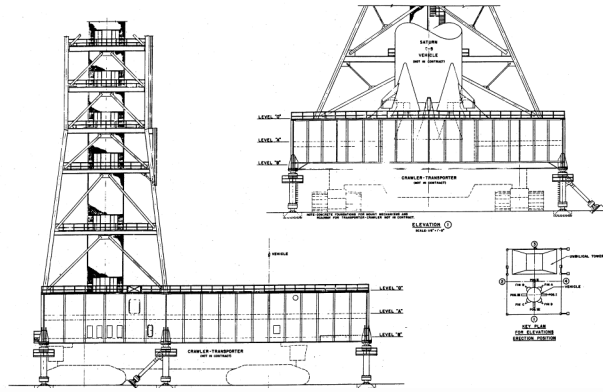

Drawing of Mobile Launch Platform and the lower levels of the LUT.

Credit: NASA

service structures and countless other buildings-erected within a few years to create a whole architectural landscape of space flight. One of the most prominent was the Launch Umbilical Tower – LUT for short. The LUT was a 120 m tall service tower of red-painted metal lattice, supporting 18 platforms of various heights to enable access and service of the Saturn V rockets by means of nine different service-arms. It stood on the Mobile Launcher Platform (MLP) which held the rocket until it's release during launch, and also added another 26 meters to the LUT's height.

The LUT served as the structure on which the stages of the Saturn V were assembled into a rocket inside the aptly named Vehicle Assembly Building (VAB). It was then used to serve and control the Saturn V from roll-out to launch. To this end, the whole edifice, LUT, MLP and Saturn V, were loaded onto the biggest self-propelled vehicle in the world, the NASA Crawler (see Volume II) and driven from

the VAB to Launch Pad 39. The LUT thus accompanied the Saturn V for most of the time the rocket actually existed as an assembled system, and became a prominent icon of the Space Program. After Apollo there were public calls to preserve one of the disassembled LUTs as a historical landmark, however, the corrosive and toxic paint flaking off the structure made that impossible and required an extensive cleanup operation instead.



Rollout of Apollo 9, January 3rd, 1969

Credit: NASA



The VAB and three LUTs under construction, January 5th, 1965

Credit: NASA

ENVIRONMENTAL  
CHAMBER INSTL  
73M06135



A vastly diminished LUT served for years as part of the Space Shuttle launch structure, but reduced in height and painted in drab grey it had lost much of its appeal, especially since the Space Shuttle was able to stand on the MLP on its own.

Due to its publicity, the LUT has become the pinnacle of Lego space modelling. Buildings like the VAB are too vast to be modelled at the 1:110 scale, plus their plain surfaces pose little challenge to the creative mind. With its various service arms, intricate lattice structure and visible plumbing, the LUT inspired a whole host of models.



A Saturn Ib with the Skylab 4 Mission on the Milkstool at the LUT.

Credit: NASA

Each model came with its very own solutions and ideas on how to depict such a complicated structure under the limit of a given variety of Lego bricks. Picking one of the existing models does not in any way imply it is superior in quality or any other way to the other. I based my selection simply on the free availability of instructions that I could use.

Bailey Fullarton was the first to create plans for a LUT and an accompanying Youtube-video which is amazing to watch. However, Both Bailey and Joseph Chambers sell their plans, which ruled them out for publication.

Michael Cameron has – as to my knowledge – not created instructions so far.

Valerie Roche built the most famous of LUTs, which



Closeup render of Nathan Radioff's Launch Umbilical Tower-model showing upper levels and service arms.

Credit: Mecabricks

gathered 10.000 supporters on Lego Ideas but unfortunately failed the review since Lego decided not to pursue any other 1:110 space models. Valerie's model came with instructions, but Valerie was the first victim of a couple of Chinese companies that started selling knock-off sets of the models created by the modelling community, presenting them as their own creation. Valerie understandably grew wary of sharing her instructions freely, therefore the decision was made not to use the Roche-Kremer-LUT, either.

This left Nathan Radioff's model of the LUT, which made me very happy in the end. Not only are Nathan's instructions extensive and beautiful, his model had also been created with a great attention to detail and faithfulness to the original.



Nathan Radioff's Launch Umbilical Tower-model with the Saturn V.

Credit: Mecabricks





The Saturn V resting on Nathan Readloff's Launch Umbilical Tower-model, with the base of the Launch Tower visible to the left.

Credit: Mecabricks

Nathan even found a reasonable way to create all 18 levels at realistic proportions. This might sound trivial, but one of the biggest challenges for modelers in creating the LUT at 1:110 was to arrive at a "proper" height of each of the upper levels while limiting the number of required parts to a reasonable level – insofar any set containing more than 8000 pieces can be called reasonable. But having thoroughly reviewed all digital models available, I believe that the instruction included here definitely make the build worthwhile, and will result in an accurate model of the LUT that still remains playable and affordable.

Of course, anyone to disagree is free to pick one of the other versions and build them – I am most happy that there is a LUT for every taste and every design philosophy, and as stated previously, my

choice was not primarily informed by any notion of preferring one LUT over the other.

And I sincerely hope that each of the creators of a LUT will take this book as a compliment to his creative and intellectual efforts, and as a token of gratitude owed for the countless hours of fun I had.

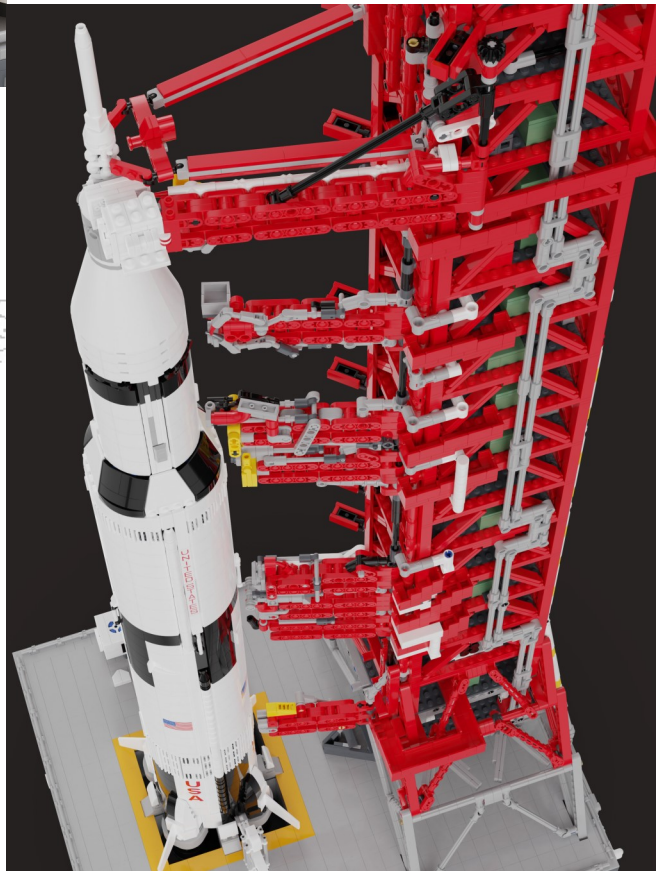

Render of Nathan Readloff's Launch Umbilical Tower model with the Saturn V ready for liftoff.

Credit: Mecabricks

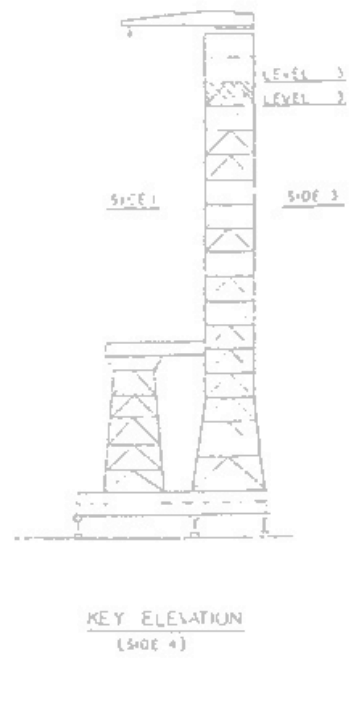
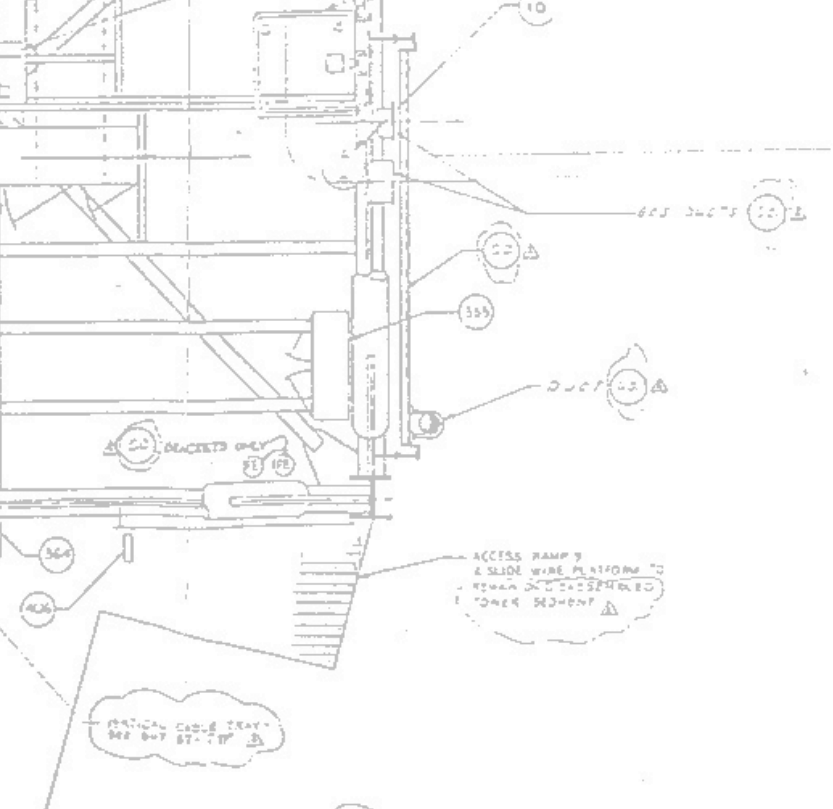



# Acknowledgements

This volume quite obviously is based on the work of Nathan Radioff, so credit belongs first and foremost to him, since his efforts for the contents of this book in terms of days, weeks and months spent designing and rendering easily surpass my own. I selfishly wanted the instructions he already published as an ebook to be included in this series, to which he graciously consented. Nathan subsequently supported my endeavor not only by answering all kinds of questions, but also by rendering new versions of instructions and all kinds of other helpful material. So realistically spoken this is in fact his book, and for this and his support I say thank you.

Bailey Fullarton was kind and helpful throughout, even before I knew I was going to edit this series, and answered my inquiries about his model after I purchased his plans patiently and kindly. I am looking forward to his next Lego creations and hope he will stay in the community for a long time.

I owe gratitude to Valerie Roche, who shared her designs with me and continues to contribute new and breathtaking projects to the Saturn community every day. I've known Valerie online for close to three years now and am amazed at the detail and ingenuity she brings to modeling, and I wish her fun and success with her new builds.

Joseph Chambers kindly provided extensive designer notes to his LUT and helped me understanding his approach to modeling better. His model is beautiful and the

instructions marvelous, and I can only encourage you to buy them from him, even if you decide to use the ones available here.

Greg Kremer spent a lot of time refining and improving Valerie's design, and summarizing them transparently in a document of designer notes. I am thankful Greg shared his model with us and allowed me to include renders in this volume.

Michael Cameron also spent nearly a year to create his own, detailed vision of the LUT. I highly encourage your to find his digital model on the Google Drive or Facebook page and check it out yourself!

Ross B Tierney from savethelut.org kindly allowed me to reprint his essay on the history of the LUT. While the ultimate goal of savethelut.org, the preservation of the dismantled LUT as a historical landmark, could not be achieved, the website is still a treasure trove of drawings, plans and pictures of the LUT which make it a required stop for anyone interested in the LUT.

As always, credit is due to the men and women of NASA, whose hard work and dedication provided nearly all the images in this book, and who continue to inspire.





# The Apollo/Saturn Mobile Launcher

© 2004 by Ross B Tierney

## Basic Structure

Each of the three Mobile Launchers stood a massive 490ft. 6in. tall, from ground level to the high-point at the top of the lightning-mast. The structures consist of four main parts:- The Hammerhead Crane on the top, the Launch Umbilical Tower (LUT), the 2-story grey Launcher Base and six 22ft. tall support legs holding the whole structure off the ground. The LUT itself is the red 380ft tall tower, with a total of 18 levels. The first two levels are separated vertically by 30ft, and all of the others by 20ft. Each level is referred to by their height, such as; "level 30", or "level 220". Attached to the side of this structure are the various Service Arms allowing access from the LUT to the rocket itself and for connecting fuel lines and direct electrical connections. On top of the 380ft. LUT is the heavy-duty crane, capable of full

360 degree rotation and able to support a maximum of 25 tons. The 25ft. tall grey Launcher Base is 160ft. 4in. long and 135ft. wide. It basically consists of two internal floors, "A" and "B", and a great deal of very heavy duty steel girders to support the great weight of the LUT and a fully fuelled Saturn-V rocket.

There is a large 45ft. square-shaped hole through the base, immediately under the rocket called an Exhaust Chamber. This blast-shielded chamber allows the engine exhaust to pass through to flame deflectors located down in the concrete Pads. These are used to divert the hot exhaust gases safely away from the rocket and ML. Around the top of this chamber are four Hold Down Arms which support the entire weight of the Saturn-V, and held it firmly in place until the moment of launch. There were also three umbilical connections, called Tail Service Masts, at the bottom of the rocket to provide liquid and electrical lines to the first stage of the Launch Vehicle. This part of the ML structure was simply referred to as the "Launcher Base" of the ML, but when they were later modified for Shuttle operations around 1980, they were officially named Mobile Launcher Platforms (MLP). Six large legs, called Mount Mechanisms, support the Mobile Launcher exactly 22ft off the ground to allow NASA's famous Crawler Transporters access underneath to lift the MLs up for transportation between the Vehicle Assembly Building (VAB) and the Pads. These Mount Mechanisms also guarantee very precise alignment of the MLs at the Pads and inside the VAB. Four more removable hydraulic pedestals, called Extensible Columns, are used out at the pad itself to help distribute the extra weight of the fully fuelled Saturn-V rocket, which tipped the scales at over 3 million kg (6,600,000 pounds) before launch.



The LUT under construction, 1964.  
Credit: NASA

## Construction

All three of the Saturn-V Mobile Launchers were built between July 1963 and March 1965. Throughout their service lives they were continually modified to suit the different missions. In total, they were used for only 17 launches from the first Saturn-V launch of the unmanned Apollo 4 through to the Saturn-1B launch of the Apollo- Soyuz Test Program spacecraft. The whole area of Launch Complex 39 was custom-designed for the preparation and launching of the gigantic 102 meter tall Saturn-V rockets to take men to the moon. At one end of the complex is the cavernous VAB – still to this day one of the largest buildings on the face of the Earth. It was built between November 1962 and June 1965. This vast building was designed to be capable of preparing up to four of the 363ft. tall Saturn-V vehicles all at the same time. In the end, only three of the four high-bays were equipped to handle the launch vehicles and the fourth was used for storage. The building measures 218 meters (716 ft.) in length, twice the length of an American Football field, and 158 meters (518 ft.) in width. It stands 160 meters (525 ft.) tall. To put that into perspective, the entire Statue of Liberty would comfortably fit through any one of the four inverted-T shaped doors on the sides. On the south-eastern side of the VAB is the smaller, somewhat squat four-story Launch Control Center (LCC), which boasted four separate firing rooms on the top floor. These consisted of four Launch Control rooms, Test Conductors Platforms, Visitors Galleries, Offices and vast



The First: Mobile Launch Platform with the new Launch Umbilical Tower and the Saturn V launcher of Apollo 4, all carried towards Launch Pad 39a atop the Nasa crawler, 19th June 1967 .

Credit: NASA

computer rooms. Other floors contained telemetry equipment, cafeterias and numerous other facilities for the launch complex.



VAB, Crawlerway & Pads during Apollo 11 Rollout - 20th May 1969

Credit: NASA





MSS approaches Apollo 8 at LC-39A - 15th August 1963.  
Credit: NASA

The Crawlerway connects the VAB with the two launch pads out near the coastline. It too is built on a scale rarely ever seen anywhere. Started in November of 1963 and completed nearly two years later in August 1965 it basically consists of two lanes from each doorway of the VAB out to the launch pads. The Crawlerway splits about a mile from Pad A to afford access to both Pads. Each of the gravel covered lanes span 12 meters (40 ft.), with a total width measuring 39 meters (90 ft.). The enormous 8,165,000 kilogram (18 million pound) assemblage of Crawler Transporter, Mobile Launcher and Saturn Launch Vehicle required a very special low-friction surface to be found. Engineers chose Alabama river gravel for its particular combination of qualities and it is still in use today. The two Launch Pads themselves, LC-39A and LC-39B, were built between November 1963 and October 1965. The identical pads are each roughly octagonal in shape and cover 130 hectares (half a square mile).

The 18 meter (59 ft.) wide flame trench at the pads could not be sunk below ground level as the water table around the cape is very close to the surface. This required that the pads themselves be raised up by 13 meters (42 ft.). The distinctive concrete "hill" in the center of the pads was the result. Surrounding the pads are lots of ancillary equipment used for fuelling and pre-flight maintenance. When the Mobile Launcher is moved to the pad it aligns very care-

fully with all of the electrical and propellant lines for all the different stages and systems.

The fuelling process for a Moon mission was very complex indeed. The first stage of the vehicle used RP-1 fuel (a highly refined form of kerosene) and liquid Oxygen (LOX) oxidizer at  $-138$  degrees Celsius ( $-297$  Fahrenheit). The second and third stages also used cryogenic liquid Oxygen but used liquid Hydrogen fuel at  $-253$  Celsius ( $-423$  Fahrenheit) instead of RP-1. Other hypergolic fuels (fuels that chemically ignite on contact and do not require artificial ignition) such as Nitrogen tetroxide (AKA Aerozine-50) and Monomethyl hydrazine were also utilised.

The final piece of major hardware at LC-39, completed in late 1966, was the Mobile Service Structure (MSS). This tall tower consisted of a lattice-work assembly approximately 125 meters (410 ft.) tall, with a base approximately 41 meters (135 ft.) by 40 meters (132 ft.) across and tipping the scales at 4,800,000 kilograms (10,500,000 pounds).

The MSS was moved around by the Crawler Transporters, just as the ML was. Near the top of the structure were five complex work platforms. When the MSS locked against the Mobile Launcher it would engulf the entire top of the Launch Vehicle and provide complete 360 degree clean-room access to the Command Module, Service Module and Lunar Module out at the Launch Pad. When not in use, the single MSS stood half-way down the Crawlerway at the point where it splits from Pad A to Pad B.



LC-39A under construction - 1st January 1965

Credit: NASA

## Operations

Mobile Launcher number 1 first saw service in 1966. In preparation for the first Saturn-V launch, a full engineering mock-up Saturn-V stack, called a Facilities Verification Vehicle (FVV), and designated vehicle number SA-500F. SA-500F was never launched, It was rolled out of the VAB on 25th May 1966 to Pad LC-39A in order to test all the procedures and equipment which would later be required during the Apollo flights. After use it was disassembled and various parts used for testing elsewhere. The unfortunate thing about SA-500F was that this non-flight example of the hardware was used by most model manufacturers as the primary source material, however it was not the same as the eventual flight examples. Many parts, especially the colour scheme, were not the same as eventual flight hardware. On 19th June 1967, the first flight-ready Saturn-V (SA-501) launch vehicle was rolled out to Launch Complex 39A onboard ML-1. Nearly five months later on 9th November 1967 the unmanned Apollo 4 mission was launched successfully. Apollo 6 (SA-502) was



Apollo 12 Rollout from VAB - 8th September 1969  
Credit: NASA



S68-55424 (17 Dec. 1968) --- Ground-level view of the Apollo 8 (Spacecraft 103/Saturn 503) space vehicle at Pad A, Launch Complex 39, Kennedy Space Center (KSC). The Apollo 8 stack was photographed during a pre-launch alert-mobile service structure pull back. (Mobile launch tower on left and mobile service structure on right.)  
Credit: NASA

launched on 4th April 1968 and was again unmanned. This launch was the first use of the newly commissioned ML-2. The Tail Service Masts (TSM) were modified for this launch as they had suffered severe damage during the previous launch. The new design was kept for all subsequent flights of the Saturn-V's. The crew of Apollo 8 Frank Borman, James A. Lovell, Jr. and William A. Anders became the first people to ever see the other side of the Moon with the naked eye. The rocket (SA-503) was rolled out of the VAB to LC-39A on 14th August 1968 and the 6 day mission was launched four days before Christmas on 21st December 1968. SA-504, the flight vehicle for Apollo 9 was rolled out of the VAB on 3rd January 1969. The crew, James A. McDivitt, David R. Scott and Russell L. Schweickart were launched from ML-2 at Pad 39A on 3rd March 1969 to the Moon to practice rendezvous procedures between the Command Module *Gumdrop* and their Lunar Module *Spider* On 18th May 1969 Apollo 10 (SA-505) used two new facilities for their launch, ML-3 was finally christened by this launch and so was Launch Complex 39B (the only time this pad was used for a Moon launch). Eugene A. Cernan, John W. Young and Thomas P. Stafford successfully flight tested the Lunar Module *Snoopy* in the Moon's gravitational field. They also tested the rendezvous ability once again with their Command Module *Charlie*.





STS-1 Columbia Rollout - 29th December 1980  
Credit: NASA

The historic Apollo 11 rocket was rolled-out to Launch Complex 39A on top of ML-1 on 20th May 1969. On 16th July 1969 SA-506 was launched with her crew; Neil A. Armstrong, Edwin E. "Buzz" Aldrin, Jr. and Michael Collins. Neil Armstrong became the first man to set foot on another world on 20 July 1969 at 10:56:15 p.m. (EDT) when his and Buzz Aldrin's Lunar Module Eagle landed at the Sea of Tranquility on the Moon. Michael Collins remained aboard their Command Module Columbia in orbit around the Moon.

The Apollo 12 (SA-507) crew, Charles Conrad, Jr., Richard F. Gordon, Jr. and Alan L. Bean, repeated the success of Apollo 11 on 14th November 1969 when they launched from LC-39A atop ML-2. Their Yankee Clipper Command Module and Intrepid Lunar Module went to the Moon and Conrad & Gordon made landfall in the Ocean of Storm on the surface of the Moon four days later. The "successful failure" of Apollo 13 re-ignited public interest in the space program. The Saturn-V (SA-508) launched from Pad 39A on ML-3 on 11th April 1970. James A. Lovell, Jr., John L. Swigert, Jr. and Fred W. Haise, Jr. were extremely lucky to survive an explosion in their Service Module on their way to the Moon. They had to use their Lunar Module Aquarius as a life-boat as they made their way around the back of the moon before they could re-enter their Command Module Odyssey. Further problems developed with the Carbon-dioxide levels and energy con-

sumption. Throughout the mission, the public across the world waited with bated breath to see if the three men so far from home could possibly survive. It was a minor miracle that the crew managed to re-start their frozen computers prior to re-entry and were able to control their trajectory to avoid burning up in the atmosphere. The crew and many NASA personnel on Earth were put under extraordinary pressure and although the mission did not succeed in its primary mission - to land on the moon - the crew survived the experience thanks to a very dedicated and magnificent team.

After the events of Apollo 13, the Apollo 14 mission was very carefully prepared indeed and eventually Alan B. Shepard, Jr. (America's first Man in Space), Stuart A. Roosa and Edgar D. Mitchell flew SA-509 to the Moon, launched from ML-2 at LC-39A on 31st January 1971. Shepard and Roosa landed Antares at Apollo 13's destination; Fra Mauro while Mitchell orbited in the Kitty Hawk. Apollo 15 (SA-510) flew successfully from ML-3 at Pad 39A again on 26th July 1971 taking David R. Scott and James B. Irwin to Hadley- Apennine on the Moon aboard Falcon while Alfred M. Worden flew Endeavour. ML -3 also launched Apollo 16 (SA-511) from LC-39A successfully nearly a full year later on 16th April 1972.



Boosted aloft atop a Saturn IB rocket, and utilizing a special "milk stool" to raise its umbilical connections to the proper levels on the Pad 39B gantry, the third and final Skylab crew takes flight on 16 November 1973.  
Credit: NASA



The Saturn V stack and its mobile launch tower are atop a huge crawler-transporter at the Rollout of Apollo 15 -11th May 1971

Credit: NASA

John W. Young and Charles M. Duke, Jr. landed the LM Casper in the Descartes Highlands on the surface of the Moon while Thomas K. Mattingly II took care of their Command Module Orion.

The final manned mission to the Moon, Apollo 17 (SA-512) was also launched by ML-3 from LC-39A on 7th December 1972. Eugene A. Cernan & Harrison H. Schmitt descended to the Taurus-Littrow Highlands aboard Challenger along with a Lunar Roving Vehicle. Ronald E. Evans was the Command Module America pilot. The next use of the Mobile Launchers was for the SkyLab project. The Space Station itself was launched atop a modified Saturn-V rocket from LC-39A on the modified ML-2. The Crew Service Arm had been moved lower down the tower for access to the laboratory section. The stack was launched on 14th May 1973. The launch was fairly successful, but the first crew up to the station had to endure a long spacewalk in order to repair damage which occurred during the launch. At the same time the unmanned SkyLab-1 Saturn-V launch vehicle was being prepared on LC-39A, over at LC-39B a heavily modified ML-1 was being prepared to launch a much smaller Saturn-1B rocket for the manned SkyLab-2 mission. The Mobile Launcher had been modified with a tall pedestal or "Milkstool" to raise the rocket up to use the existing Service Arms for the Saturn-V. In essence, the top stages of

both rockets were fundamentally the same, so this was a logical way of using the existing hardware. The three crewmen; Charles Conrad, Jr., Paul J. Weitz and Joseph P. Kerwin were launched on 25th May 1973, and performed repairs to the station before successfully continuing their 28 day mission. SkyLab-3, another Saturn-1B, launched from ML-1 at LC-39B, followed on 28th July 1973 taking Alan L. Bean, Jack R. Lousma and Owen K. Garriott up to the laboratory for their 59 day mission.

SkyLab-4 launched on 16th November 1973 taking Gerald P. Carr, William R. Pogue and Edward G. Gibson up to the Station for their 84 day mission aboard a third Saturn-1B rocket. As before, this mission launched from ML-1 at Pad 39B. This was the last visit to SkyLab. Eventually it impacted the surface of the Earth on 11th July 1979. According to NASA, the debris rained down across the South-Eastern Indian Ocean and across a sparsely populated section of Western Australia. The final use of an Apollo-era Mobile Launcher was on 15th July 1975 for the Apollo/Soyuz Test Program. Another Saturn-1B was used atop the Milkstool on ML-1. The 9 day mission undertaken by Thomas P. Stafford, Vance D. Brand and Donald K. Slayton was to rendezvous and dock with a Russian Soyuz module in orbit. The docked segment of the mission lasted two days and both craft returned safely to the Earth. After Apollo: Once NASA's new reusable Space Shuttle concept was confirmed, the launch facilities at LC-39 had to be extensively modified to work with the new design. The Apollo-era Mobile Launchers would become a very significant part of the new Launch system.

Attached to the FSS is an all-new structure, called the Rotating Service Structure (RSS).



Moving ML-3 to Pad B - 20th July 1976

Credit: NASA



This assembly rotates around the Shuttle's cargo-bay to provide a clean-room environment out at the Pad, for preparing each mission payload before flight. All three ML's were carefully dismantled with plans for their re-use. The 380ft tall red LUT towers were separated from all three of the 2-story grey Launcher Bases. The Bases were later converted for use with the Shuttle, and today they are designated as Mobile Launcher Platforms (MLP). The Shuttle Stacks (consisting of 2 Solid-Rocket Boosters, External Fuel Tank and Orbiter) are mounted upon the MLP's in the modified Vehicle Assembly Building (VAB). They are then rolled out to the same Launch Pads that were used during the Apollo-era, and are launched directly off of the MLP, just like the Saturn-V's before them. The red LUT towers of ML-2 and ML-3 were also re-used for Shuttle operations.



Service Arms in the Boneyard at John F. Kennedy Space

Center, prior to their removal.

Credit: Greg Katnik., 2004. Used with kind permission.

Most of the structure of ML-2 is today fixed in position on the concrete Launch Pad at LC-39A forming the backbone of the Fixed Service Structure (FSS).

## Mission Summary

Mission: Vehicle: Rollout: Launch: ML: Pad: Crew:

Static Test AS-500F 25th May 1966 Never flown 1 39-A Never flown

Apollo 4 AS-501 19th June 1967 9th November 1967 1 39-A Unmanned

Apollo 6 AS-502 6th February 1968 4th April 1968 2 39-A Unmanned

Apollo 8 AS-503 14th August 1968 21st December 1968 1 39-A Frank Borman, James A. Lovell, Jr., William A. Anders

Apollo 9 AS-504 3rd January 1969 3rd March 1969 2 39-A James A. McDivitt, David R. Scott, Russell L. Schweickart

Apollo 10 AS-505 11th March 1969 18th May 1969 3 39-B Eugene A. Cernan, John W. Young, Thomas P. Stafford

Apollo 11 AS-506 20th May 1969 16th July 1969 1 39-A Neil A. Armstrong, Edwin E. "Buzz" Aldrin, Jr., Michael Collins

Apollo 12 AS-507 8th September 1969 14th November 1969 2 39-A Charles Conrad, Jr., Richard F. Gordon, Jr., Alan L. Bean

Apollo 13 AS-508 8th December 1969 11th April 1970 3 39-A James A. Lovell, Jr., John L. Swigert, Jr., Fred W. Haise, Jr.

Apollo 14 AS-509 9th November 1969 31st January

1971 2 39-A Alan B. Shepard, Jr., Stuart A. Roosa, Edgar D. Mitchell

Apollo 15 AS-510 11th May 1971 26th July 1971 3 39-A David R. Scott, James B. Irwin, Alfred M. Worden

Apollo 16 AS-511 13th December 1971 16th April 1972 3 39-A John W. Young, Thomas K. Mattingly II, Charles M. Duke, Jr.

Apollo 17 AS-512 28th August 1972 7th December 1972 3 39-A Eugene A. Cernan, Harrison H. Schmitt, Ronald E. Evans

SkyLab AS-513 16th April 1973 14th May 1973 2 39-A Unmanned

SkyLab 2 AS-206 26th February 1973 25th May 1973 1 39-B Charles Conrad, Jr., Paul J. Weitz, Joseph P. Kerwin

SkyLab 3 AS-207 11th June 1973 28th July 1973 1 39-B Alan L. Bean, Jack R. Lousma, Owen K. Garriott

SkyLab 4 AS-208 14th August 1973 16th November 1973 1 39-B Gerald P. Carr, William R. Pogue, Edward G. Gibson

Apollo/Soyuz AS-209 24th March 1975 15th July 1975 1 39-B Thomas P. Stafford, Vance D. Brand and Donald K. Slayton

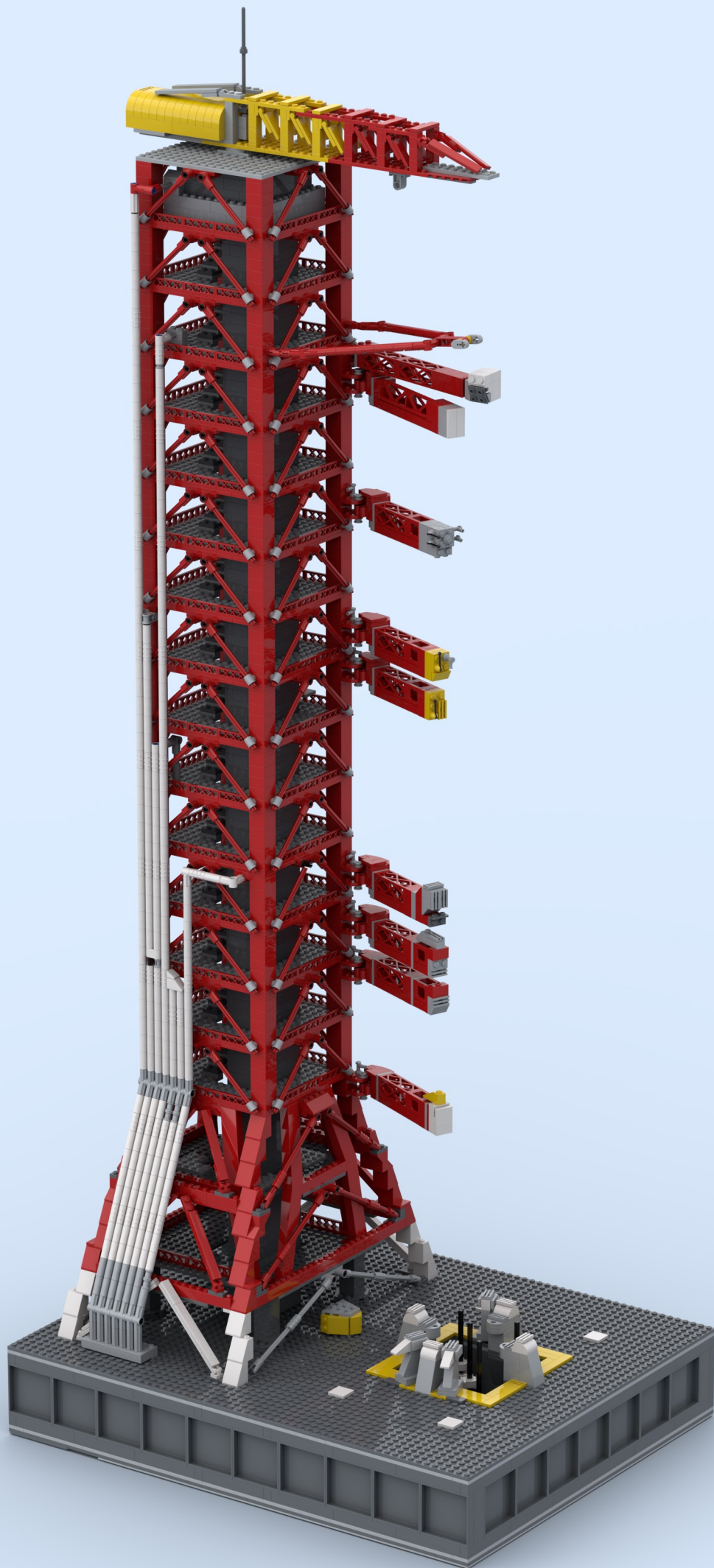

# The Bailey Fullarton LUT

I have some reasons for the inherent lack of specifics with my tower. I'll take you back to mid May 2017. Some friends and I were excited at the prospect of the Saturn V getting the go ahead for production, and I set out to try and build a tower of the same scale. I often just drop myself into LDD and dabble around for a few hours when the urge comes so even a 1.2m tall structure like this wasn't too out of the ordinary. As I went along, I erred on the side of proportional accuracy, using NASA diagrams to scale the general details as best I could. I wasn't an enthusiast, I wasn't a mad space buff. I have an interest in space, but LEGO is where my passion lies.

I posted a reasonably finished render online at the end of May and it was met with quite great praise. One week later, June 6, LEGO officially green-lights the Saturn 5 for production, and my inbox on Flickr, Gmail, and Facebook were going mental. After posting my tower to an Apollo Era fan-page on Facebook, I was met with about 700 likes straight off the bat, with real Astronauts, NASA engineers and relatives of that worked on the tower all voicing their joy. Hundreds of comments left right and centre for me to sell plans were coming through, so I tried to get the tower to a better, more final version before making any decisions.

The announcement video came out which showed the final model of the rocket, and someone on reddit managed to LDD the rocket as close as possible based on stills. Using that file, I redesigned the tower again to fit what we all thought the rocket would eventually be, but with a distinct lack of knowledge on the topic, I omitted many of the details you are all now so familiar with. It wasn't apathy, I just simply didn't know the importance.

More and more messages were coming through urging me to sell my plans to the point where I was at 50+ notifications a day to skim through. I needed to give people what they wanted. I created some plans, put together a bit of a package and said (as I still do) that I'd be willing to help anyone building it with any questions they may have in the process. \$10 USD seemed a fair price, and so far I've only had one person get annoyed at it funnily enough (they paid anyway), so I think it definitely was the right price! There we go. It's done, people have what they want, they saw what they were getting, I wasn't hiding anything.

Designer	Bailey Fullarton
Published	May 30 <sup>th</sup> , 2017
Price for instructions	\$ 10
Parts	4385
Lots	239
Measurements (in Studs)	48 x 60 x 154.2
Measurements (in cm)	38,4 x 48,0 x 123,4
Weight (in g)	6401,8

The Saturn V Ideas set is released and by that time this page now comes about and now with more and more people interested in the set, the theme and how to display it, and more people joining the page, I was starting to get requests to purchase the plans based solely on my reputation alone, referring to my build as the 'Fullarton LUT'.

Other people started having a go at designing different interpretations of the tower. I won't say better although many of them are, because some of them are now even more cost prohibitive than mine, some are missing details others have, no one's design is infallible. It was time for me to take a back seat.

I am still ready and willing to help with build questions as promised, and all of your support has not been for nothing. With the money I saved from sales, I was able to go on a trip to Europe to LEGO's HQ, meet some incredible people and enjoy the trip of a life time. I'm not too well off, so this experience has given me an opportunity I could only have dreamed of.

On the inverse, I've had so many people share stories of connecting with their sons, daughters, grandkids, parents and other relatives over this build. I've had people from all walks of life tell me of how this community and this project has been a refresher for them.

So no, my builds not perfect, it's not a technical masterpiece. It's a backdrop, for a wonderful set, a display piece designed by someone that just wanted to make people a bit happy. If you spot something inconsistent, or lacking, the beauty of LEGO is to build.



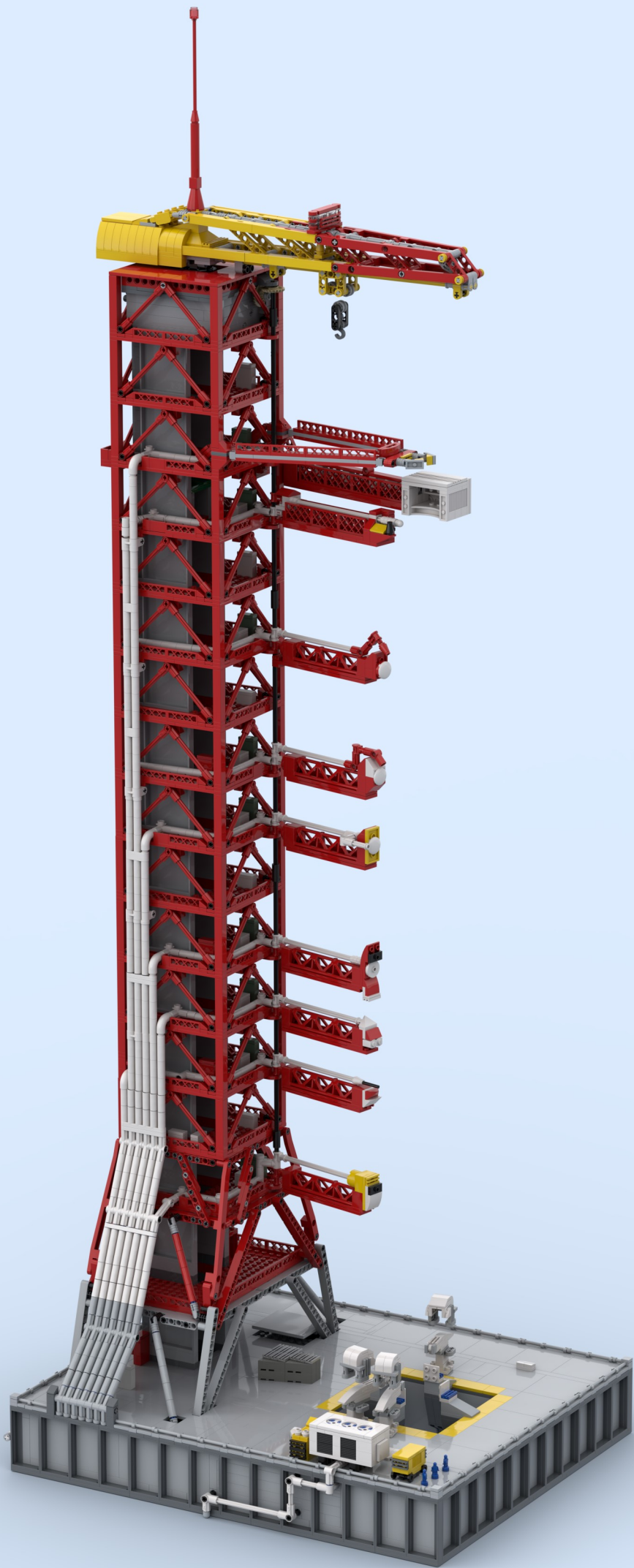

# The Roche-Kremer LUT

This design is being offered by Valérie Roche and Greg Kremer. Valerie is co-creator of the design originally offered to Lego Ideas, and Greg extensively modified that design to make it buildable, structurally sound, and to add new features and details.

Of the 3000-odd parts in the original design, over 500 were not available. In many cases, a reasonable color substitution took care of the issue. In other cases, the unavailable part(s) had to be designed out and replaced with alternate design. The goal was to be able to purchase every component via BrickLink. This was 99% accomplished. The design as offered here includes a small number of axles (mostly white ones) unavailable (or very expensive) in certain lengths. You have the option of replacing those with an alternate color, or order longer (more available, cheaper) parts in the correct color and cut to length.

All the “action” features of the original design have been carried into the new design:

- Moving elevator
- Rotating crane
- Raise/lower crane hook
- Synchronous rotation of gantry services arms from service to launch position
- Retractable tail service mast arms
- Retractable LES service arm
- Additional detail has been added: Descending catwalk on the back of Level 300 to provide crew access to the service arm
- Stairs on each level (with an appropriate hole in the deck)
- “Deluxe” plumbing - mostly to avoid those rare & expensive 32L white axles, plus those new “macaroni” elbows look great
- More equipment boxes, on every level!

The design is implemented using Studio 2.0 (free) from BrickLink. The design file serves, for better or worse, as the building guide. Construction has been organized into steps, and assemblies into sub-models. The “Instruction mode” of Studio (which is new for 2.0) seems to handle that pretty well for the most part. This document adds instructions and descriptions for anything not implicit in the Studio step sequence, for example, rigging features such as the

Designer	Valerie Roche / Greg Cremer
Published	June 3 <sup>rd</sup> , 2017
Price	free
Parts	5038
Lots	480
Measurements (in Studs)	47 x 57 x 166,1
Measurements (in cm)	37,6 x 45,6 x 132,9
Weight (in g)	5065

crane and elevator, and any other unorthodox build issues. Thanks to Valerie & others for providing the elevator and crane rigging diagrams. In addition to the two design variants, the ZIP file containing the design files also has separate files broken out by sub-assemblies. (These were then simply imported and assembled into the “LUT-assy” models.) When using design files as building guides, I recommend using the sub-assembly files.

Unlike the real-life LUT, Valerie’s original design has 14 levels above the tapered part of the tower, not 15. The tapered part is to scale (70 plates in height). The 14 levels are one plate taller than scale height, to make up for the missing level. This leaves the tower 7 plates\* (2 ½ bricks) short of actual scale height. With this arrangement, the gantry service arms line up with where they’re supposed to be on the Saturn 5 (which itself has some scale issues), while aligning with the tower level floors which simplifies the plumbing layout. But a more unfortunate side effect is that when the LES service truss is rotated up to the launch position, it will interfere with the crane if the crane is rotated. For comparison, a LUT built with scale height levels (i.e., 17 plates or 5 ⅔ bricks in height) would only be 1 brick shy of accurate scale height. I (Greg) have done a little work seeing how tower levels at scale height stack up. At first glance, aligning the service arms and getting them plumbed gets a lot more complicated (in an authentic way). This would be a pretty ambitious project for anyone looking for extra challenges. \*In my opinion, measuring height in “studs” (=2 ½ plates or ⅝ of a brick) is not particularly convenient.

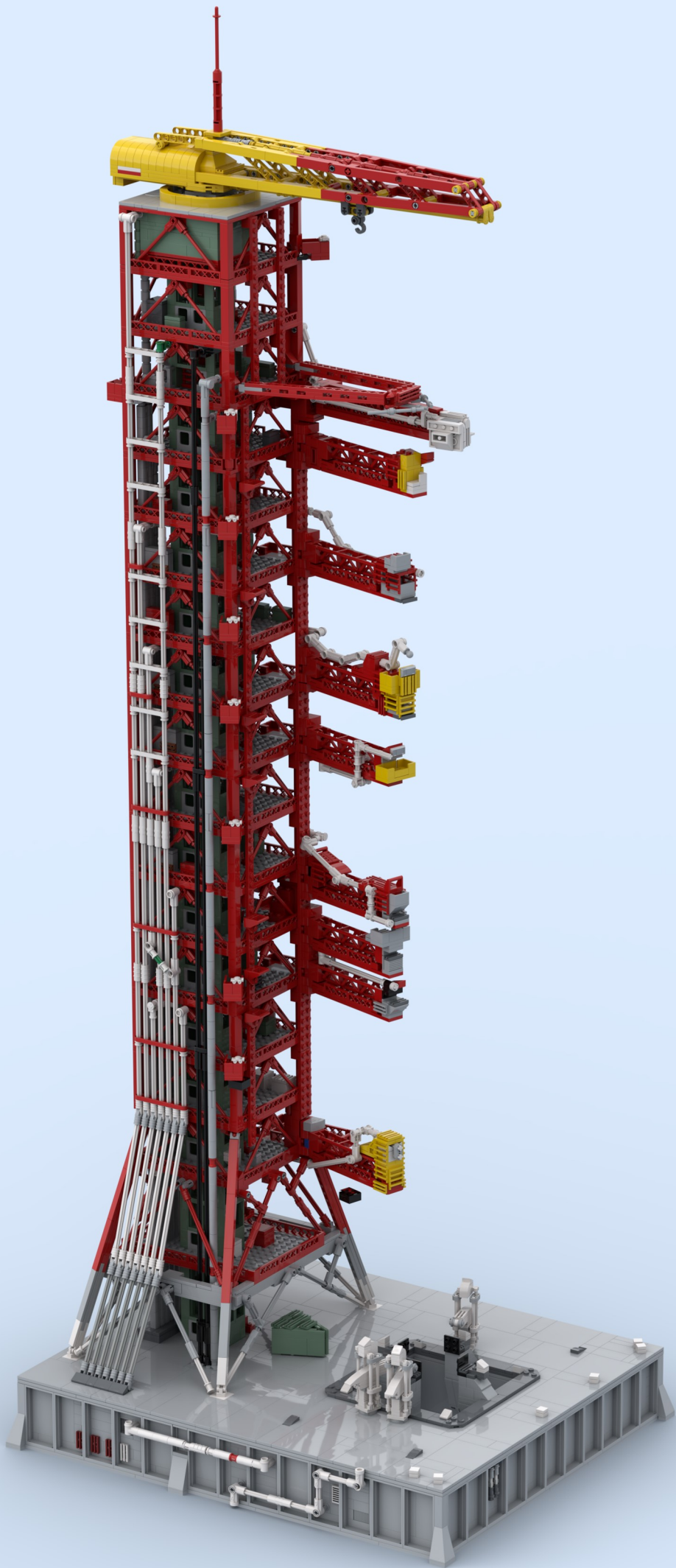

# The Michael Cameron LUT

I was inspired to make my own LUT after seeing Bailey Fullarton's MOC, but this is by-and-large my own design, with a few elements (e.g., hold down arms, crane) taken entirely or modified from Valerie Roche). I'm particularly happy with the scale and streamlined design of the lower supports, the service arm detail and the elevator shaft.

I started designing using Stud.io in February and finished in July. I collected the parts (just over 5000) in August/September and assembled/re-designed it in September/October.

There were three LUTs built for the Apollo program, each were a little different. I wanted my LUT to be as detailed/accurate as I could make it, so I focused on ML-1, the LUT used to launch Apollo-11. Obvious differences from the other builds I've seen are the colors for the frame of the exhaust-hole, and blast deflector (dark gray vs. yellow used in ML-3 for the Apollo-13 launch). Also, I wanted it to be ready for takeoff so I didn't include the ancillary support equipment (e.g., generator) that were used during crawler transport but removed before launch.

Designer	Michael Cameron
Published	Nov 9 <sup>th</sup> , 2018
Price	free
Parts	5130
Lots	495
Measurements (in Studs)	48,0 x 59,3 x 159,4
Measurements (in cm)	38,4 x 47,4 x 127
Weight (in g)	5499







# The Joseph Chambers LUT

I did not so much decide to build an LUT, it was more that I suddenly found myself collecting parts and those parts just happened to start being joined together in the shape of an LUT. The decision happened in the math-oppressed recesses of my unconscious creative brain. And in a similar fashion, I knew that I would be modifying Valerie's design to reflect the changes made to the real life LUT #2 for Skylab, I just did not realize that giving myself permission to make modifications to the design would lead to where it did. In the end – seven months and 9,000 pieces later, my current LUT design shares almost nothing in common with the original design. I still must unequivocally thank Valerie for her inspiration.

I was new to this whole MOC concept, and there were untold numbers of techniques and Lego parts that I had no idea existed. As I learned more, and as I studied more about the actual Launch Umbilical Towers and the Saturn V launch vehicle, my design kept evolving and changing. As I learned that I could be more detailed, as I discovered those techniques and parts, I integrated them into the build. Learning how to effectively use LDD and later Stud.io certainly helped the process immensely.

A couple of months into the project I had fully committed to redoing the entire design from the ground up, with a focus on detail and accuracy. I made the decision that this was going to lean more towards a model, and not a play set. By this time my LUT reached around the 10 levels tall and with a combination of sadness and excitement, I disassembled much of it to start from scratch.

The main issue I had was that the design I was working off of had the height of each level being six bricks exactly. In order for the LUT tower to be to scale with the Saturn V, I had to make each level five bricks and one plate in height. With every level needing supports for the many different pipes and risers along each side, and the different equipment on each floor, and the uniqueness of each of the service arms, every single one of the 18 levels needed to be uniquely designed and carefully measured. This could not be a build-as-I-go sort of thing. It really had to be deliberate and well-planned.

The A-frames are the part I am kind of most proud of, though. Their base is hidden deep inside the launch platform and terminate at a well-secured ball and socket joint at all 4 corners. This allows several

Designer	Joseph Chambers
Published	July 10 <sup>th</sup> , 2019
Price	\$ 15
Parts	7948
Lots	480
Measurements (in Studs)	47,7 x 59,7 x 153,3
Measurements (in cm)	38,1 x 47,8 x 122,7
Weight (in g)	7889,6

different degrees of freedom. From there the frames rise through the Lunch Platform deck to the first cross-member. At this point, the two legs are of the A-Frame are 16 studs apart, then 15 studs apart at level 2, and then 14 studs apart when they finally attach to the vertical tower structure at level 3. I had to come up with some tricks to get it to do that, but the result is that the A-Frame looks incredible, in my opinion. The whole setup is deeply non-standard, and requires that parts be bent, bowed, or rotated slightly, but it is gradual enough that you can't tell unless you're looking for it. The hinge joints where the A-Frame meets the tower are the only 4 points where any glue was used in the whole build, and only as an assurance of structural integrity.

The entire tower is covered in many pipes and risers, all with specific purposes, and all very carefully placed for accuracy. These proved to be somewhat of a challenge as not all sizes of technic axles or bar pieces come in every color. I used a lot of lightsaber hilts to connect hose and bar pieces, and plenty of T-Bar pieces (92690) for 90 degree turns. White pipes proved to be difficult as there are very few ways to make a 90 degree angle in that color. The vast majority of modified parts – and yes I will admit to cutting parts – are bars and pipes cut to fit.

Some of the parts of the build that gave me the hardest time was the attachment point of the Workshop Service arm / White Room, the gantry crane at the top of the tower, and most especially the service arms themselves. I spent perhaps too long trying to make the service arms look accurate to the original units, but I am pleased with the result in the end.



# The Nathan Radioff LUT

The inspiration for designing a model of the LUT came from seeing the version on Lego Ideas that was co-designed by Valérie Roche - it was a stunning display piece and the perfect way to show off the official Saturn V set. Rather than wait for Lego's decision on whether to make that project an official set, I started work in LDD with simple goals of making a robust, detailed model using readily available parts. I ended up spending a solid 12 months studying reference photos and original blueprints trying to make the LUT as accurate as possible, and the project ballooned into an 8133 part behemoth.

As I had never designed anything so big or so complicated, and I didn't have enough bricks on hand to test components in real life, almost every aspect of the design process was a huge challenge. The most difficult parts were the construction of the skeleton inside the MLP, and the design of the A-frames forming the base of the tower - both had to be really strong to support the weight of the model above. I'm particularly proud of the crane at the top of the tower, where I deliberately made the side struts a little too short to add some tension and stop the crane from sagging under its own weight.

The finished model includes several moving parts that reflect the actual launch procedure. The crane at the top of the tower can rotate (there is no functioning winch). The damper arm, which was used to steady the rocket during rollout, can be raised fully vertical. A gear can be turned to pull back the crew access arm from the Command module. A lever can be pulled to retract all eight main service arms. Finally, the three tail service masts can be rotated out of the way.

At the time of writing, all the parts used in this model have appeared in official sets that were released within the last two or three years. It's worth noting that a lot of the bricks inside the MLP are not visible on the outside, so the tan 2x10 bricks, blue 2x8 bricks, reddish brown 2x6 bricks and lime 2x4 bricks can be swapped out for any colour that is handy (note: one reddish brown 2x6 brick is visible on the outside).

The tower has been carefully fine-tuned to line up with the official Saturn V rocket, which (perhaps surprisingly) isn't a perfect 1:110 scale model. Some of the tower levels have been stretched taller or compressed shorter to ensure that the service arms are placed at the correct locations on the rocket.

Designer	Nathan Radioff
Published	July 6 <sup>th</sup> , 2018
Price	free
Parts	8133
Lots	482
Measurements (in Studs)	50,2 x 58,1 x 156,2
Measurements (in cm)	40,4 x 46,5 x 125
Weight (in g)	7762,2

Unfortunately, this means that while most of the tower levels are very similar, no two are actually identical - you'll need to work very slowly and carefully through this instruction manual!

Finally, the model was not designed with transportation in mind, but there is a convenient breakpoint about halfway up the tower where the two 32L axles are joined. While it isn't easy to split the tower at this point, it can be done, and may be useful.

Good luck, and happy building!

# Instructions for the Nathan Radiooff LUT

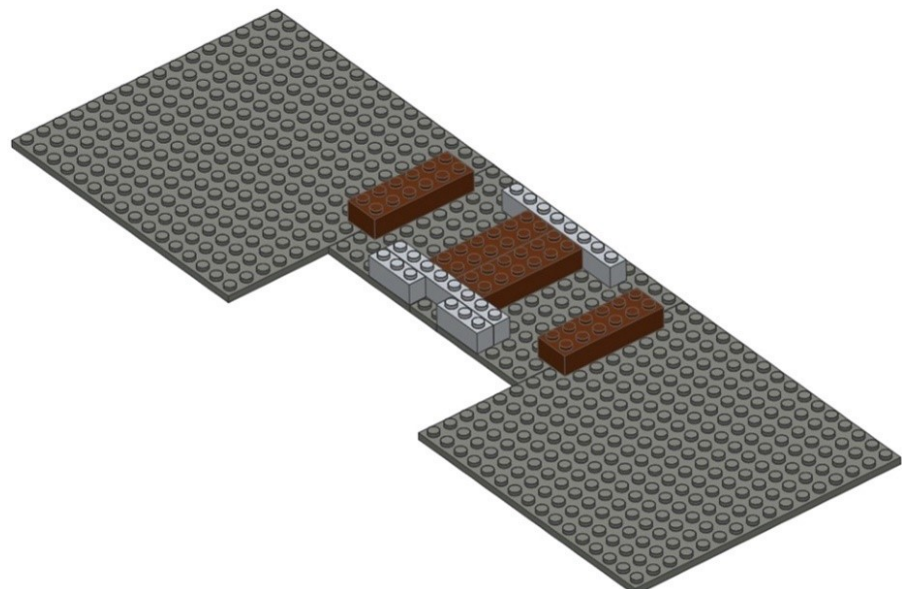
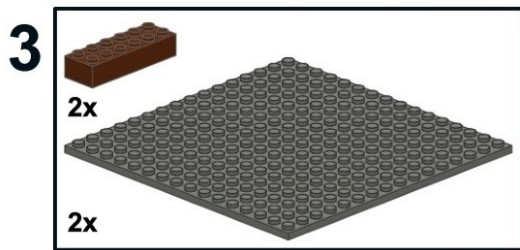
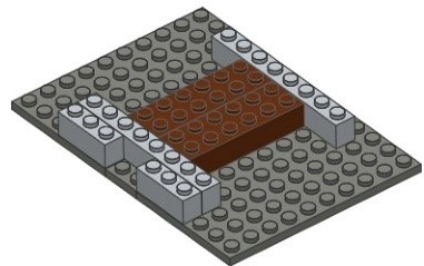
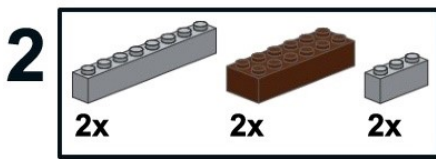
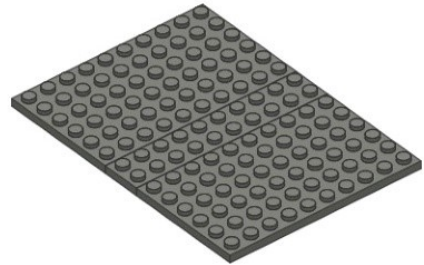
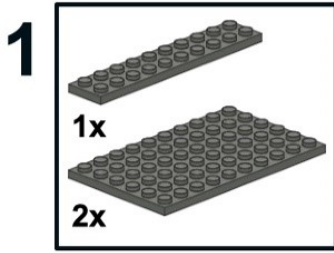



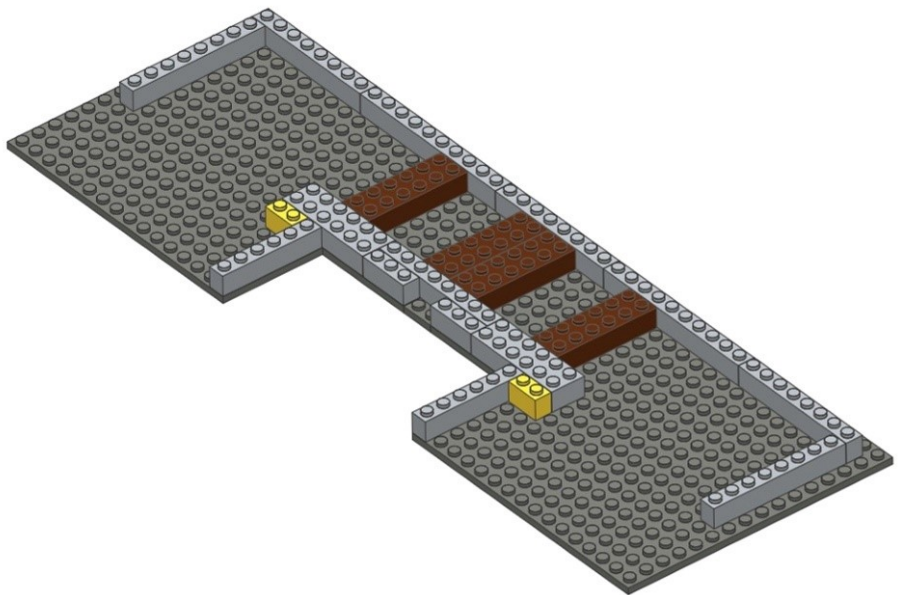
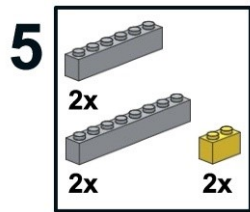
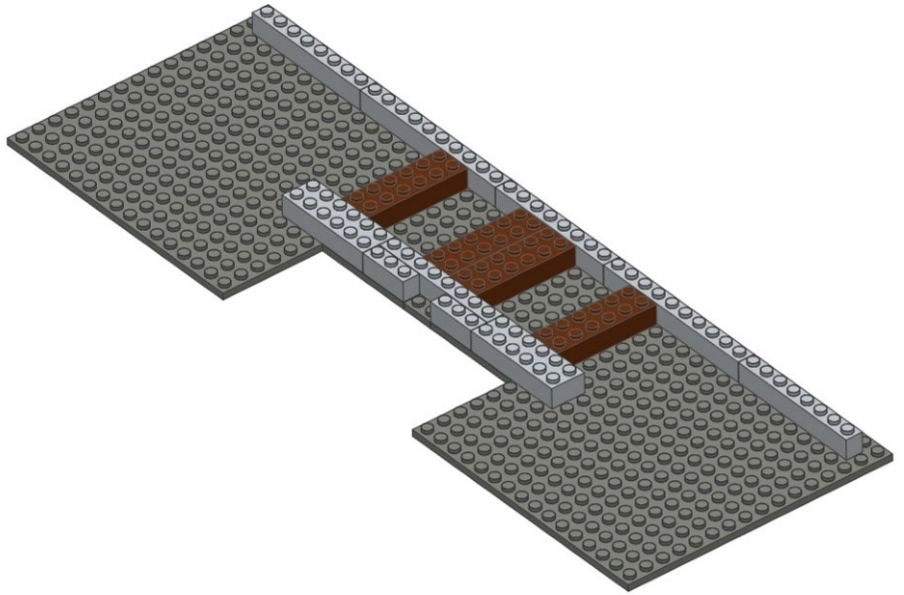
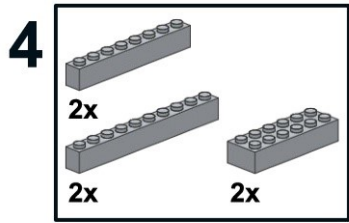

6

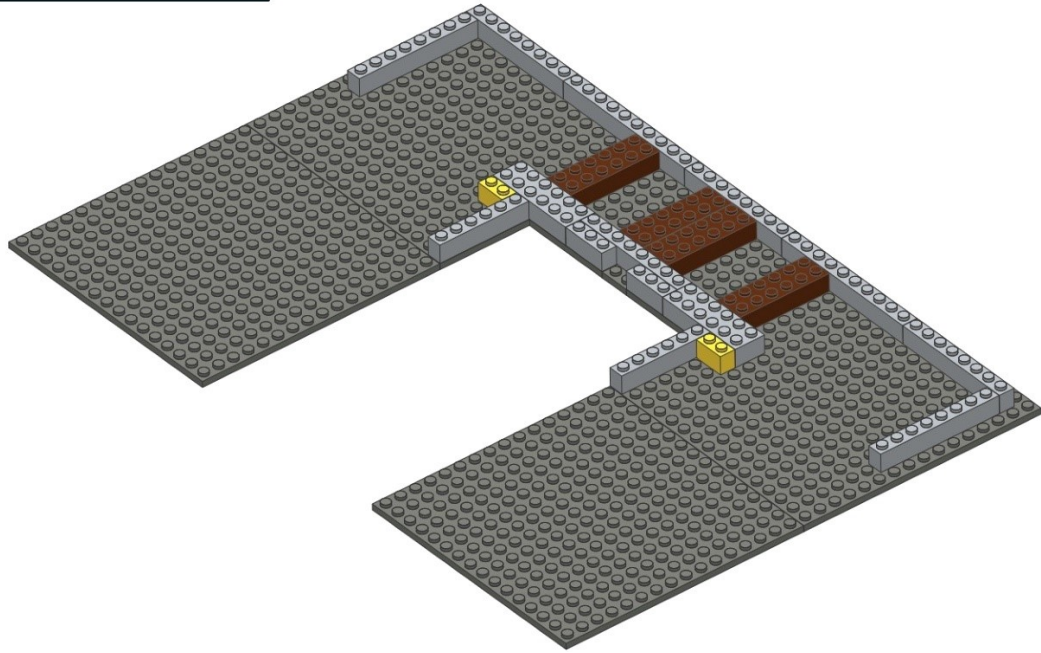
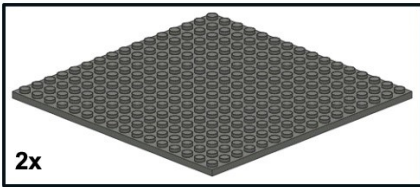

7

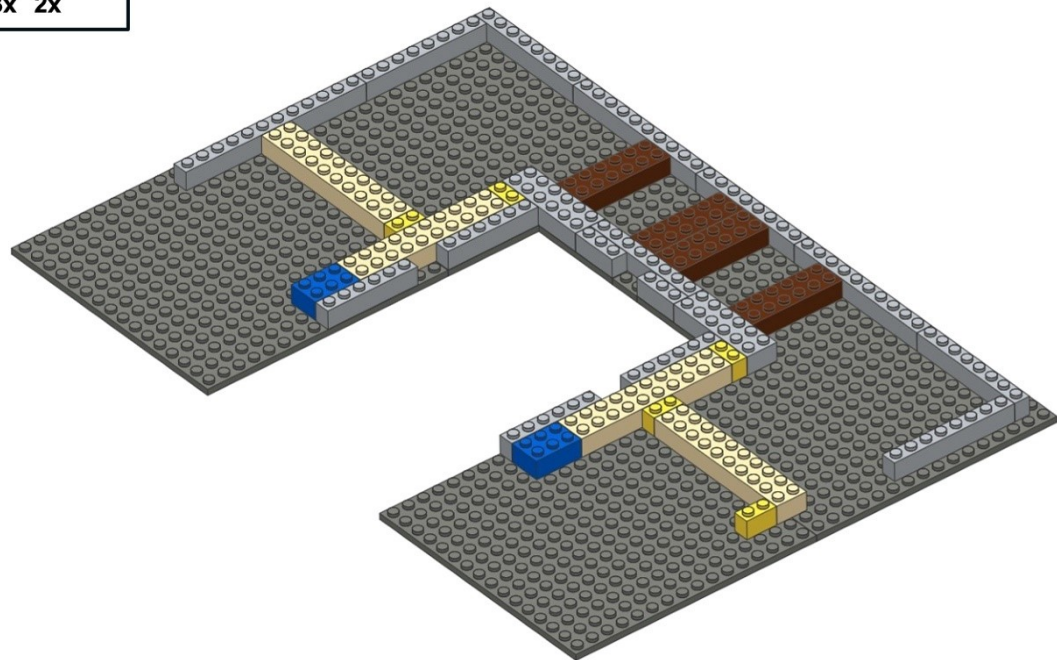
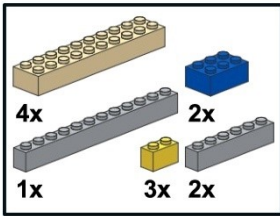



8

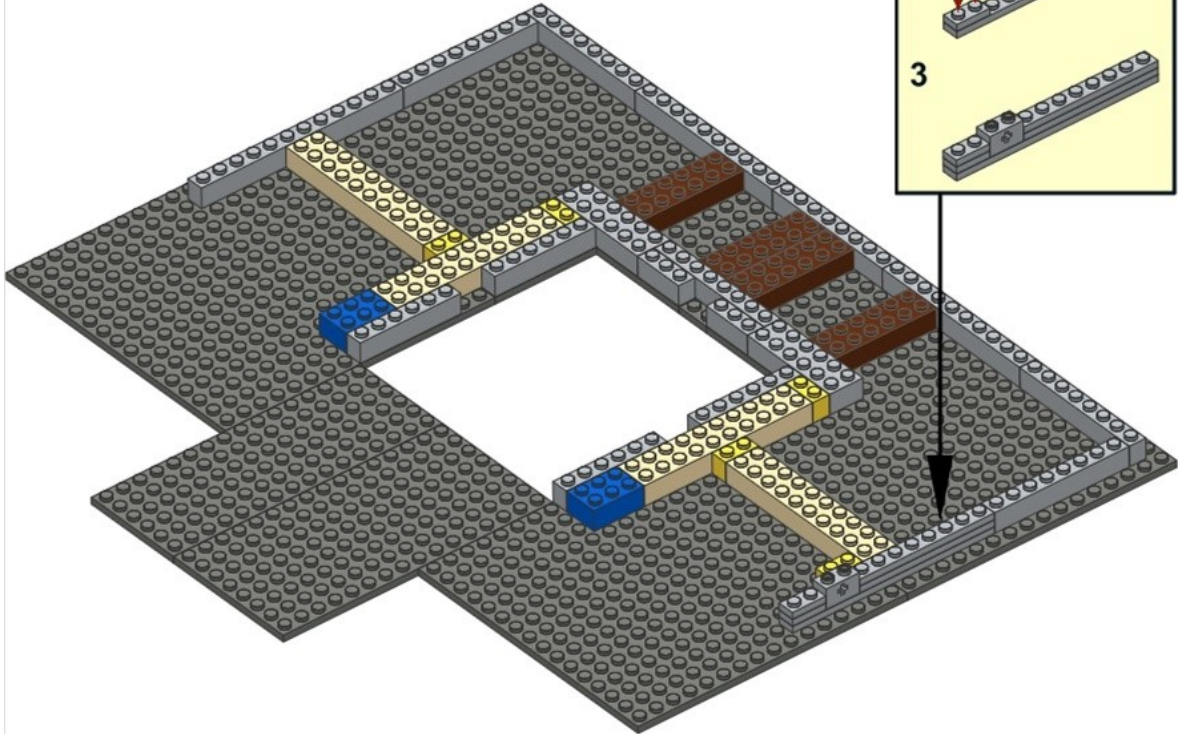
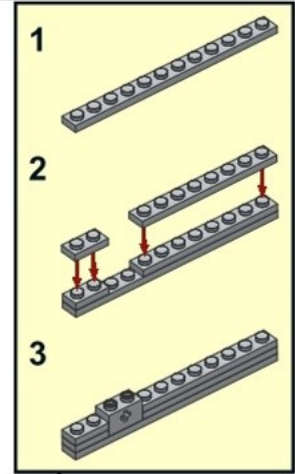
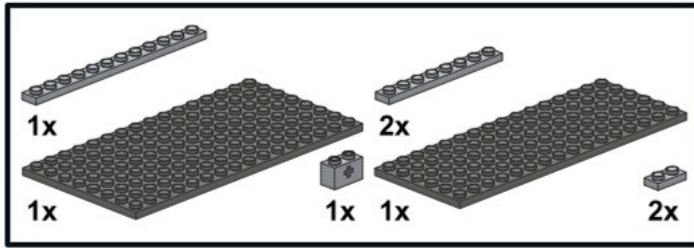

9

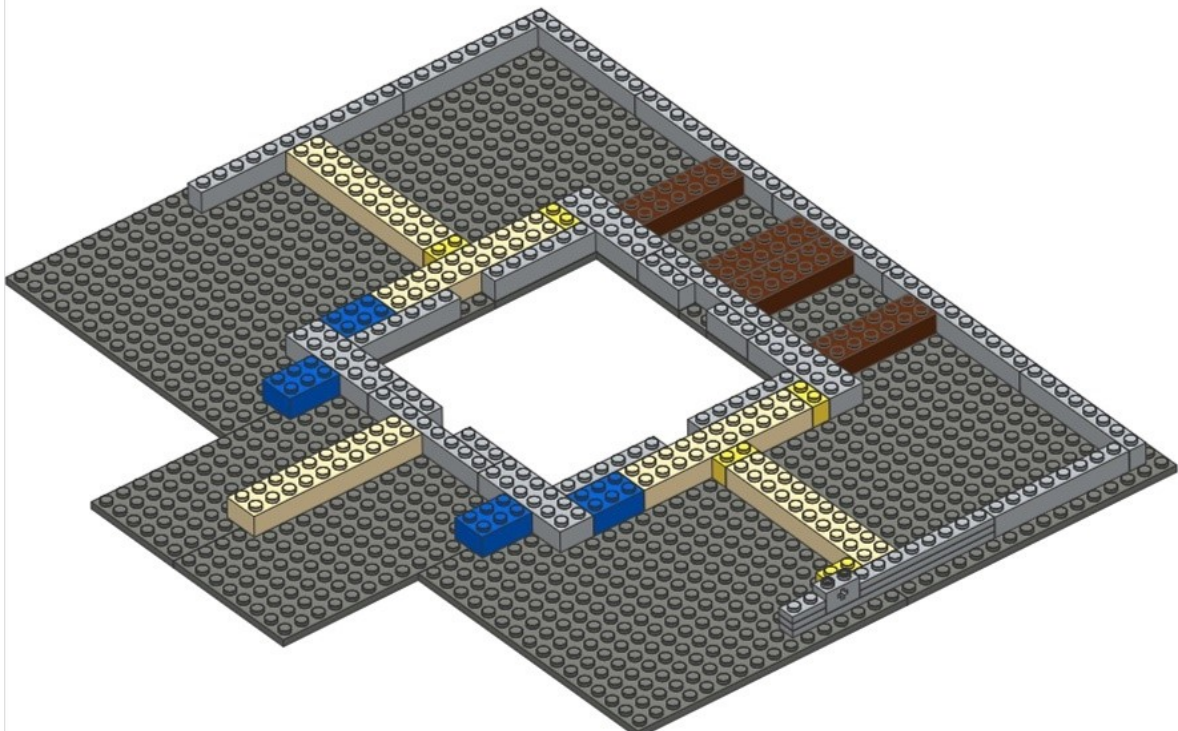
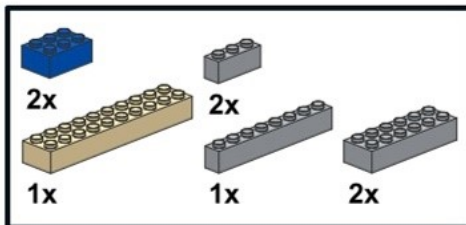



10

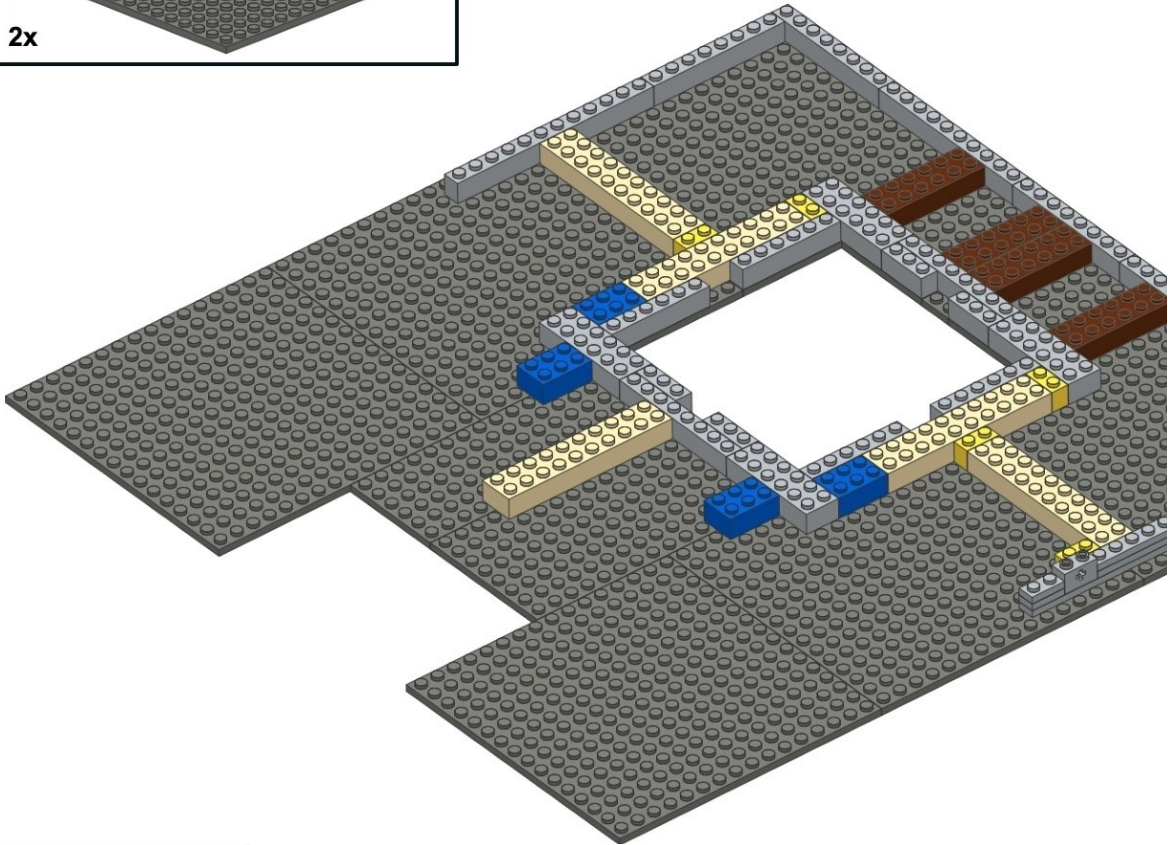
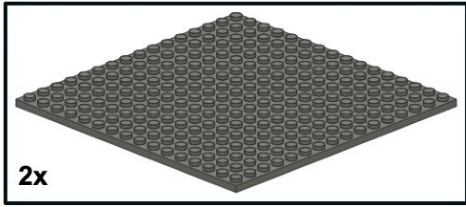

11

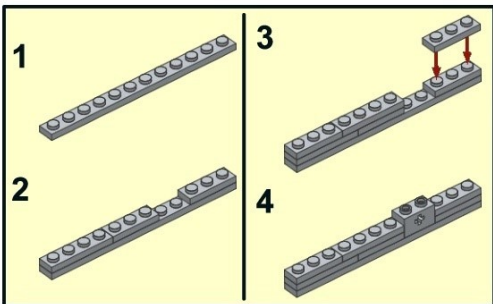
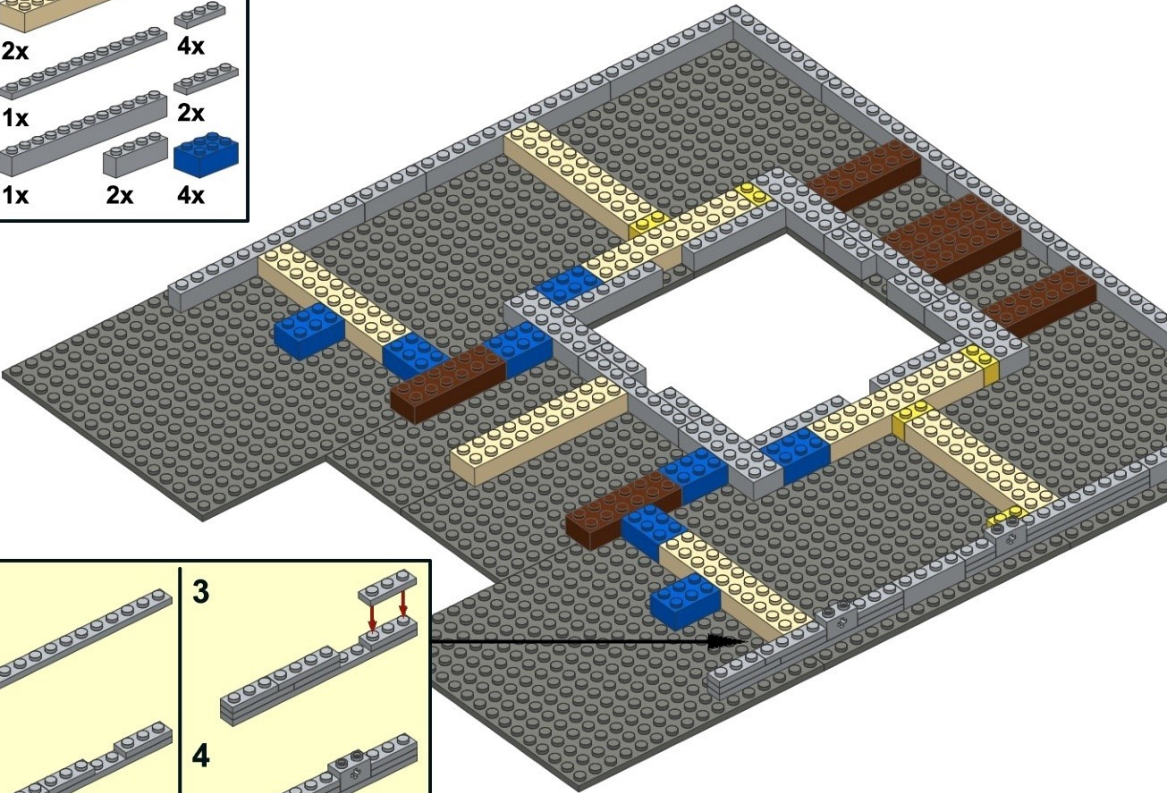
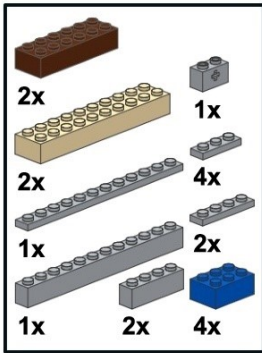



12

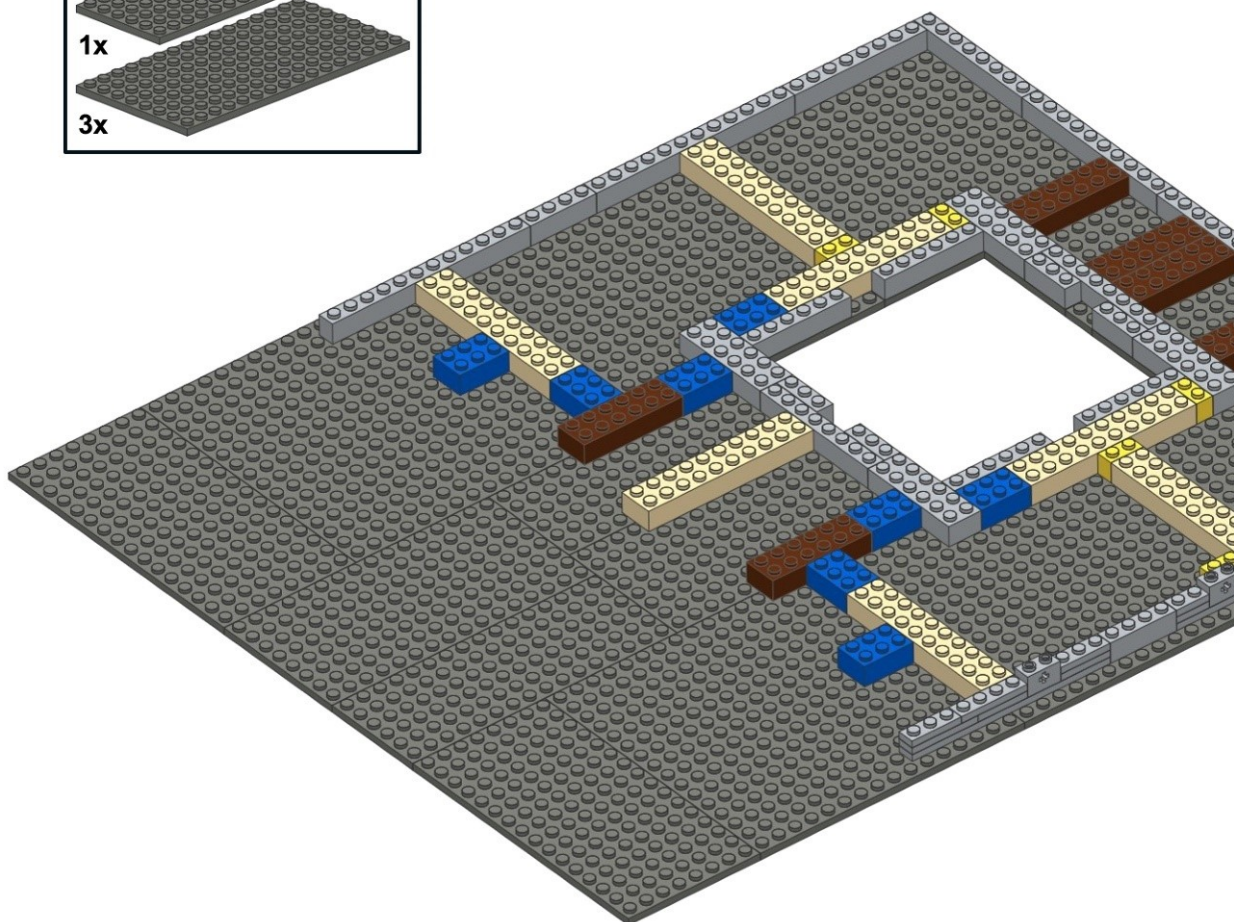
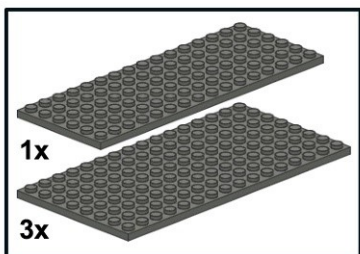

13

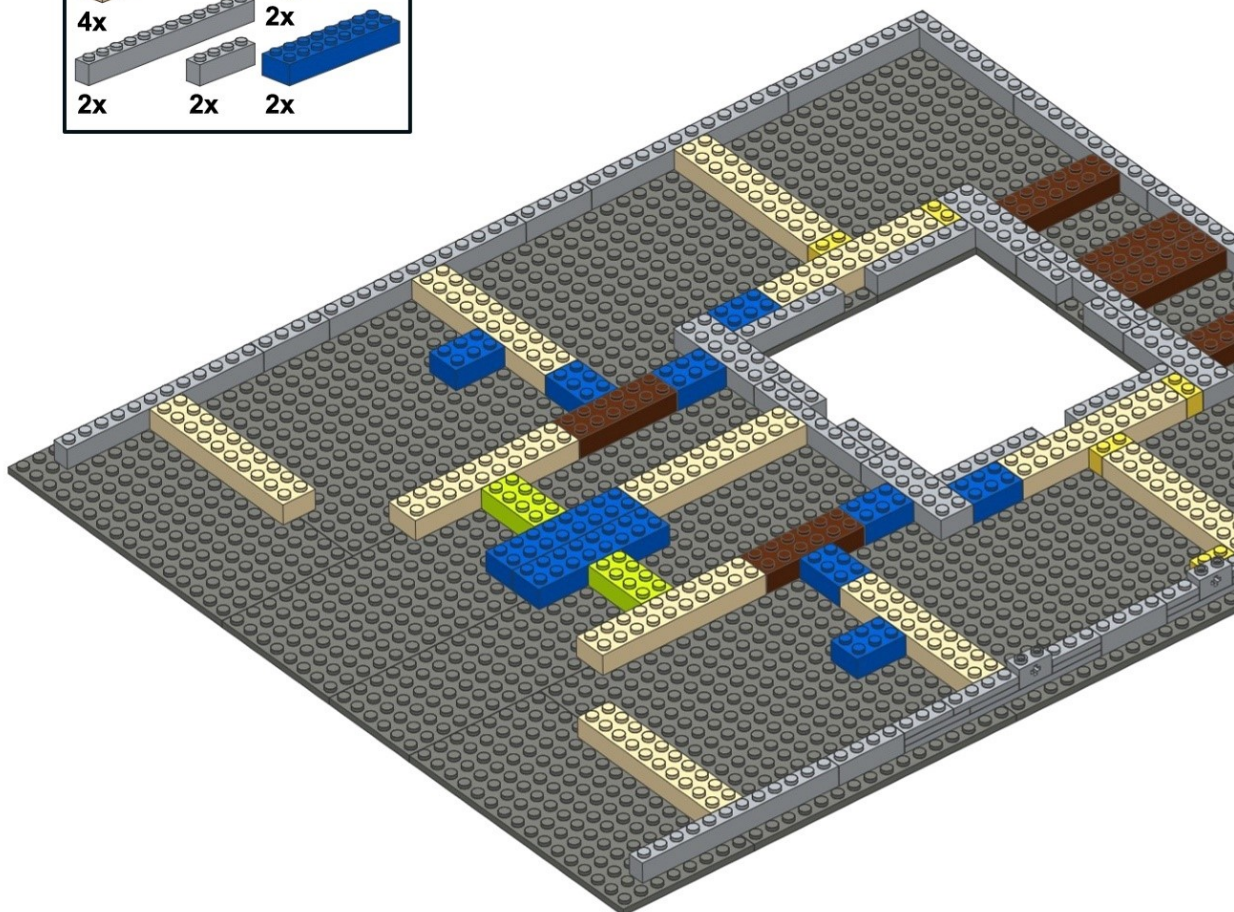
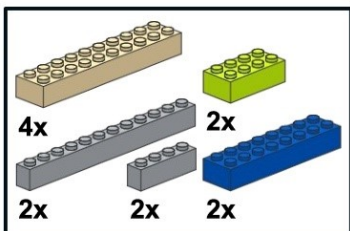



14

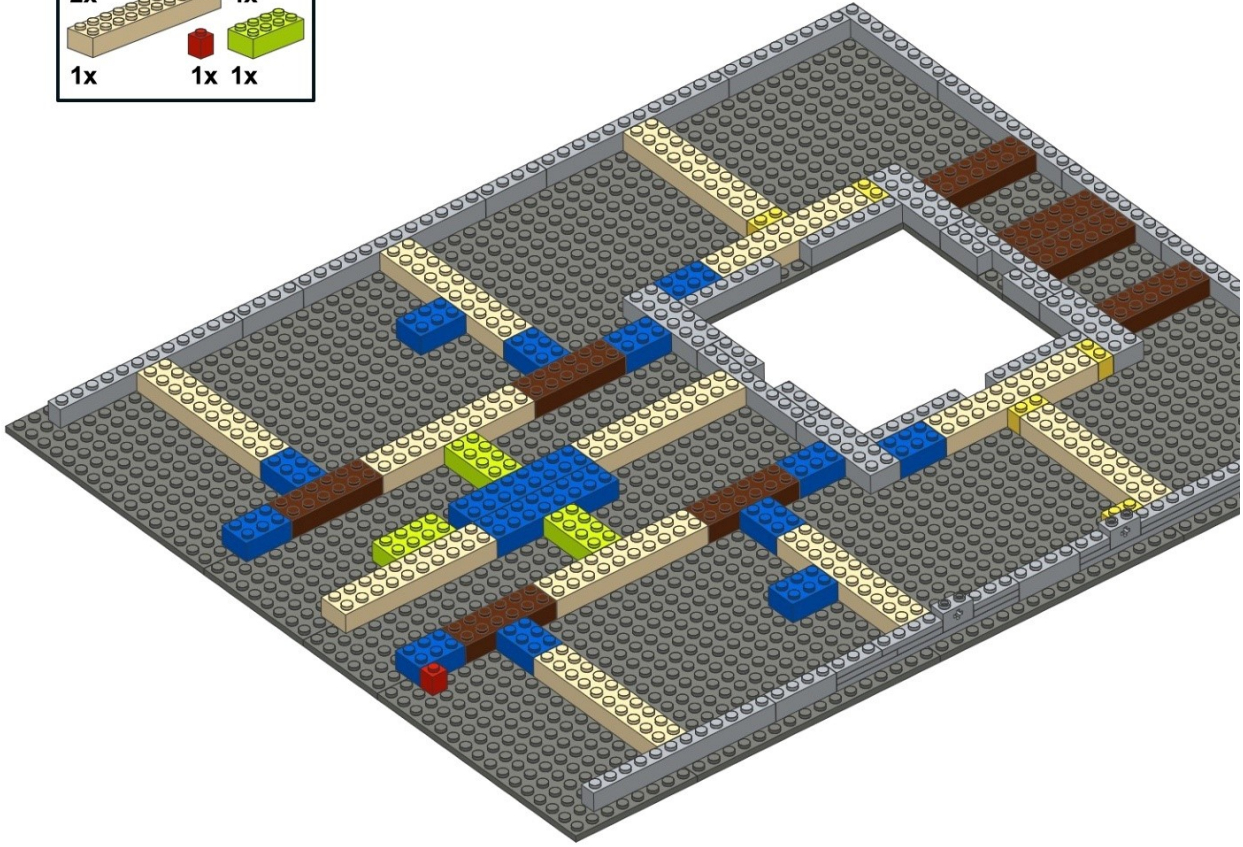
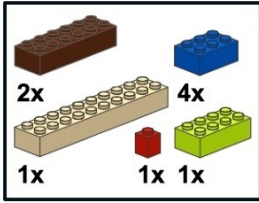

15

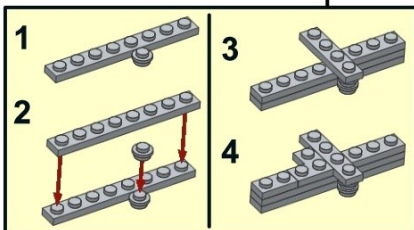
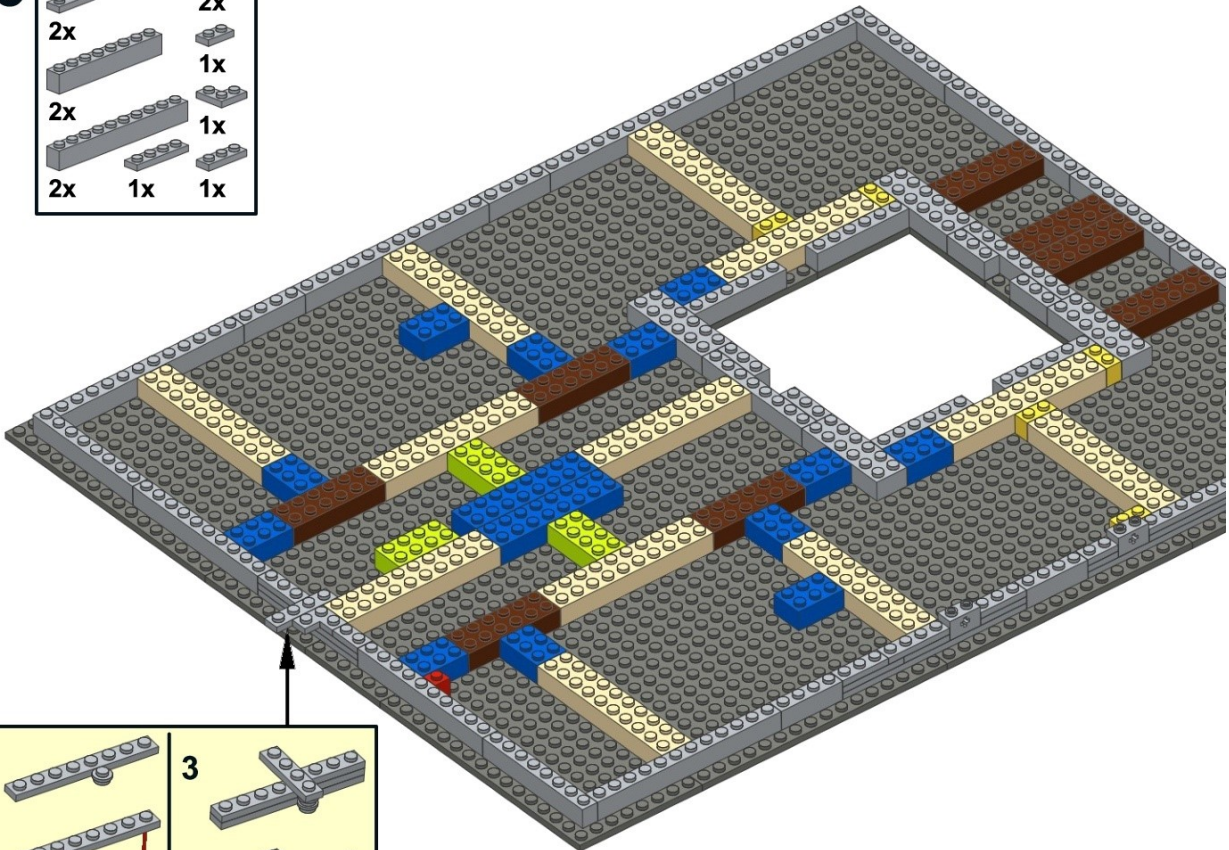
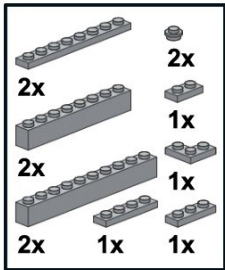



16

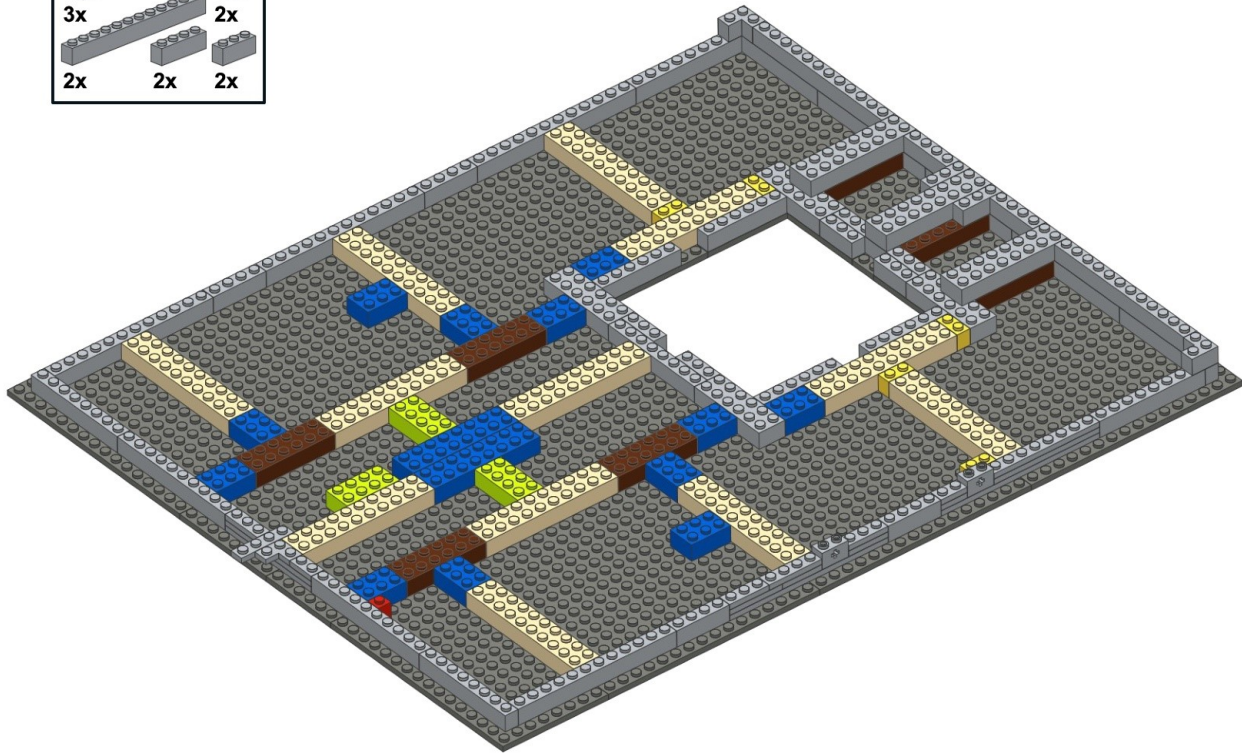
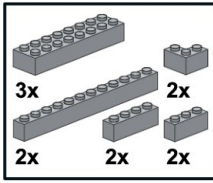

17

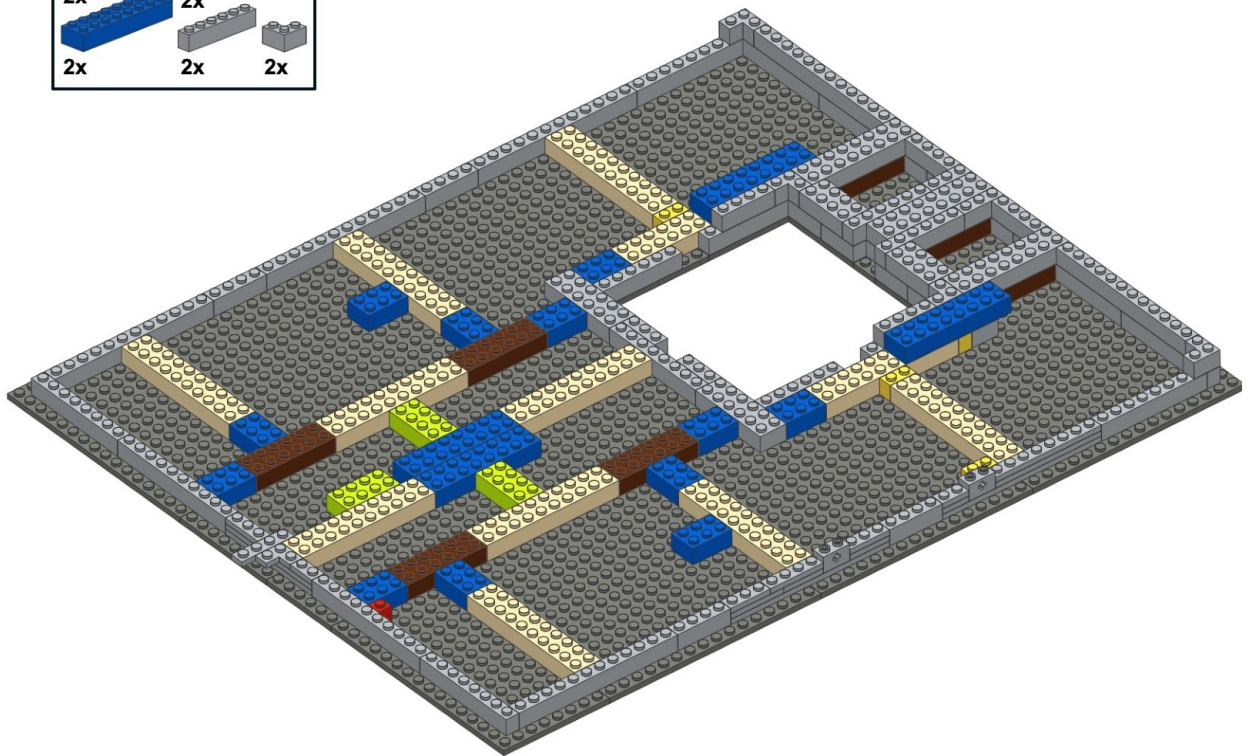
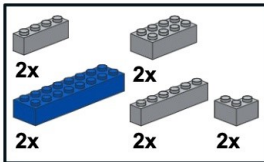



18

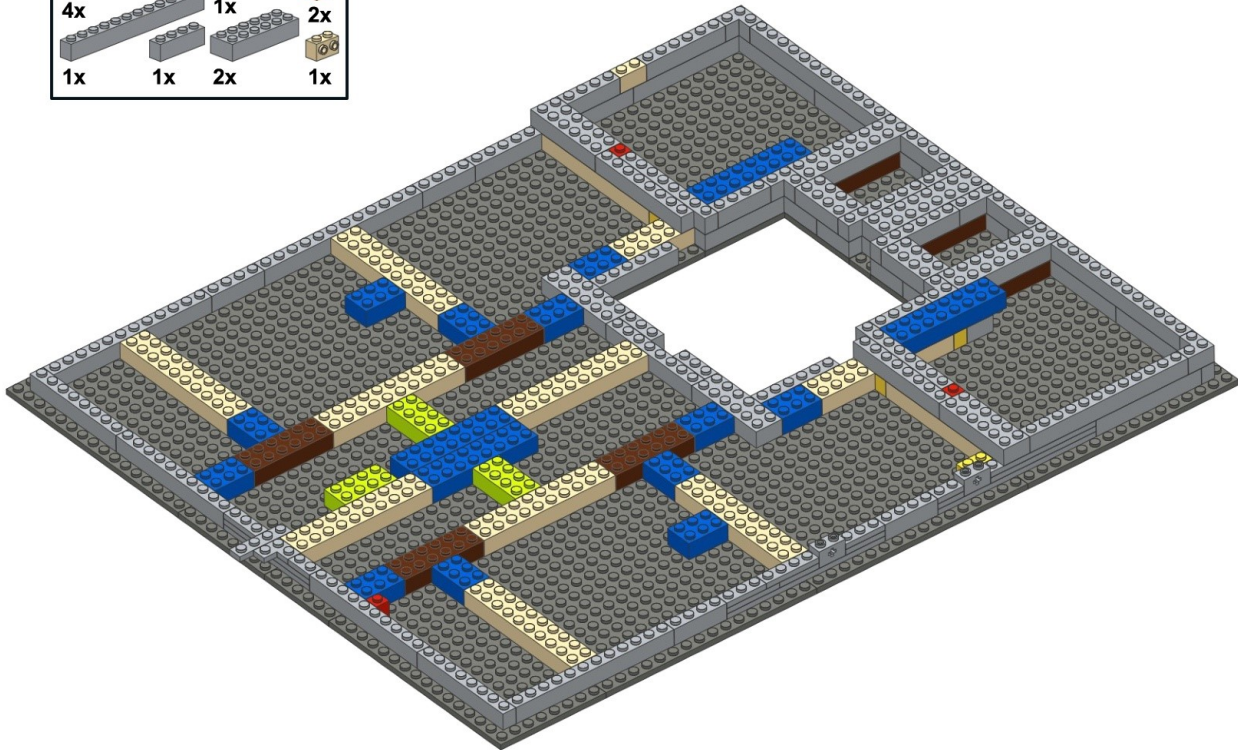
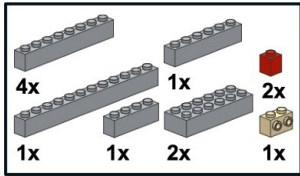

19

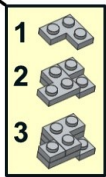
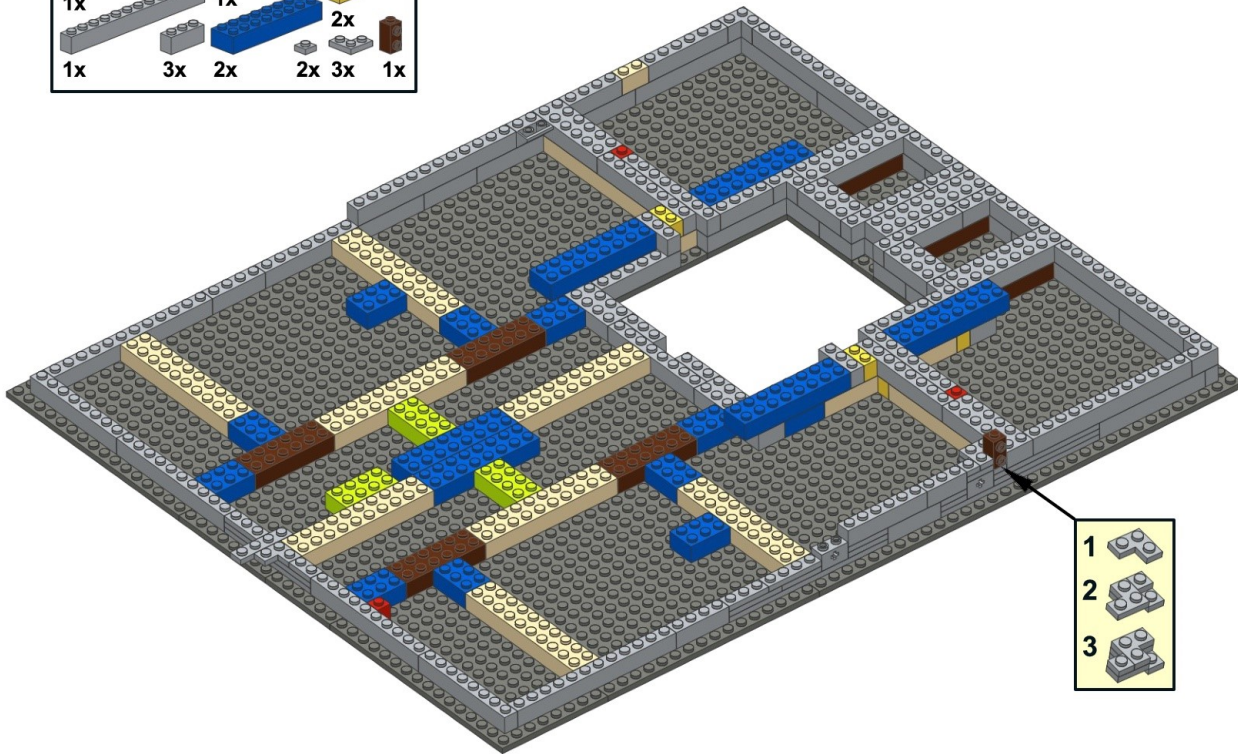
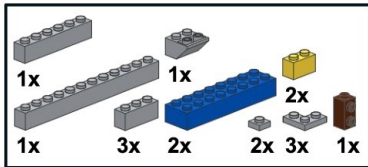



20

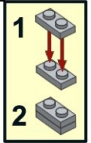
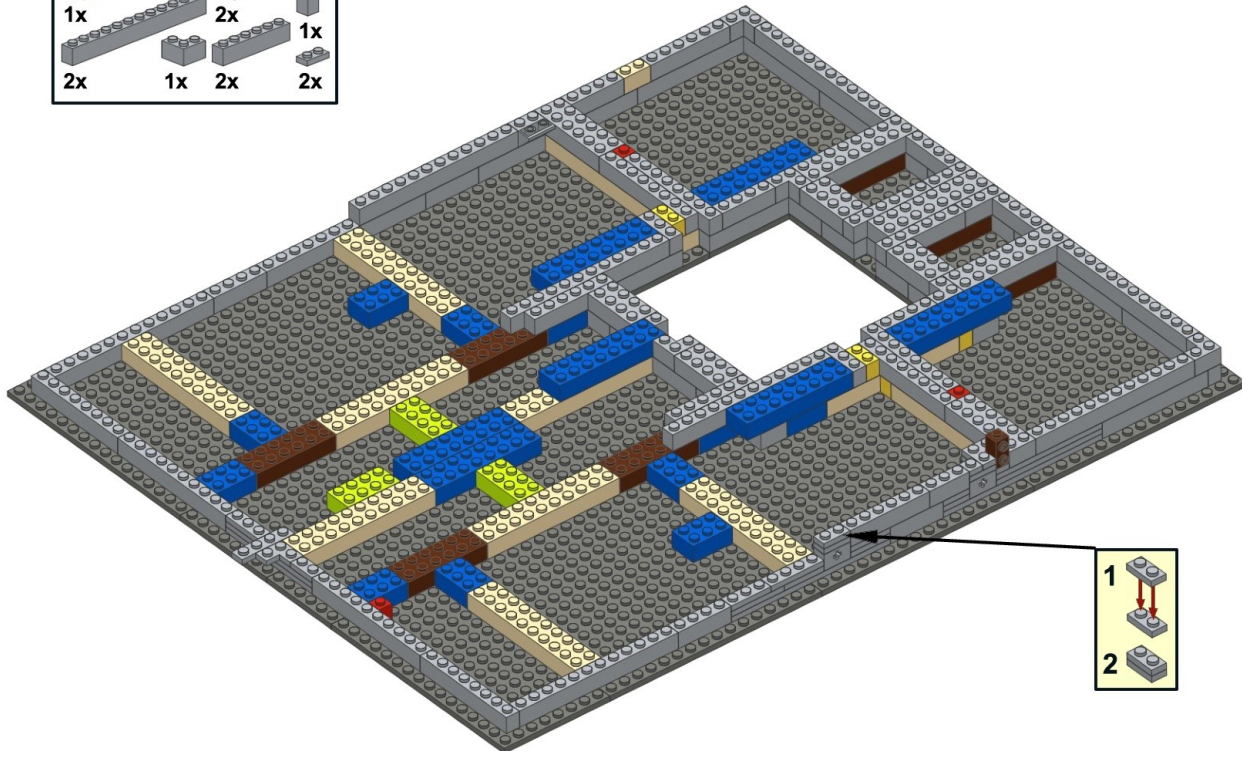
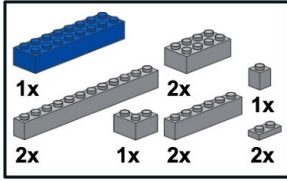

21

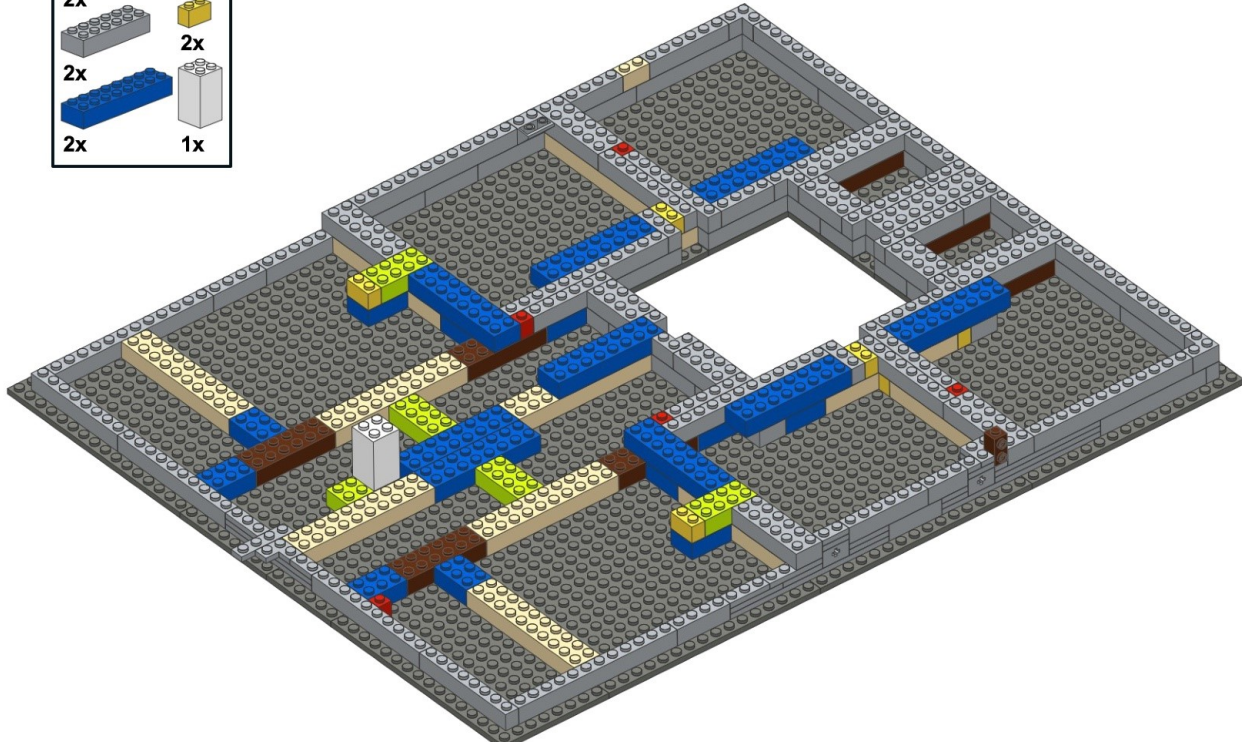
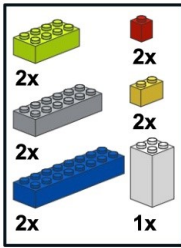



22

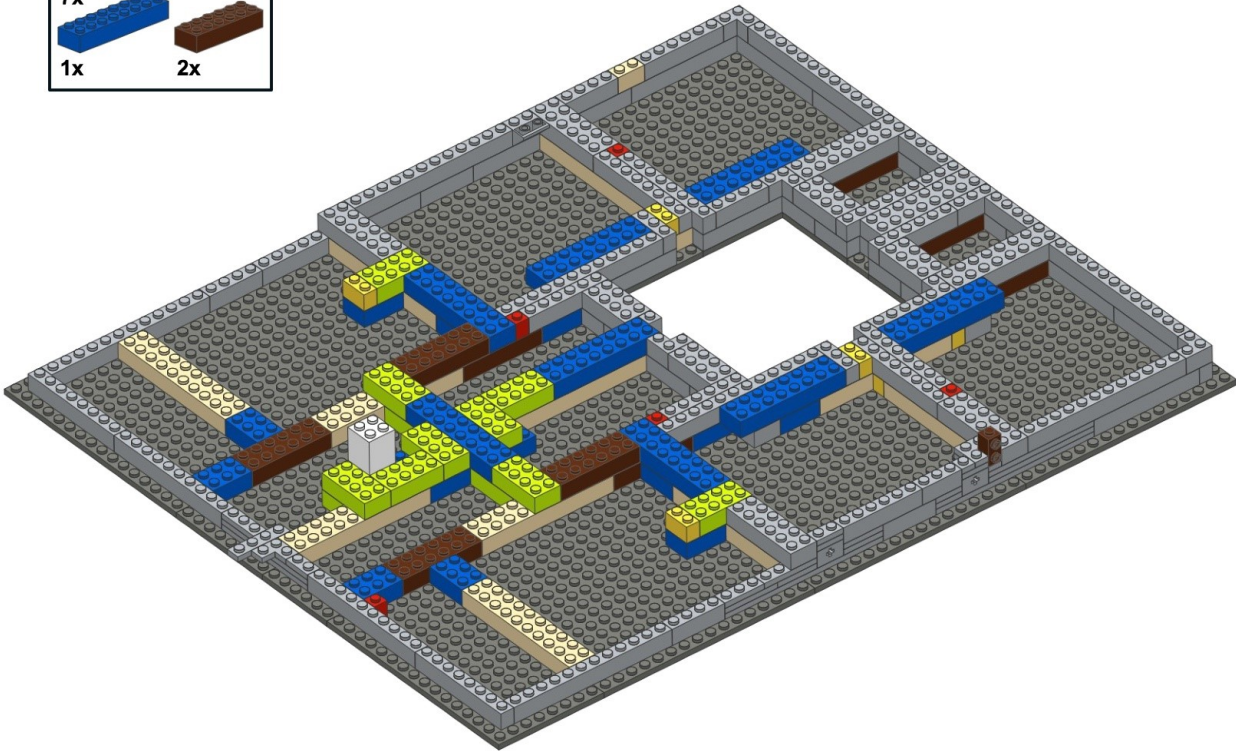
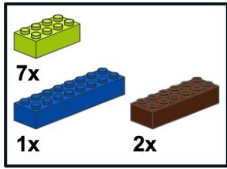

23

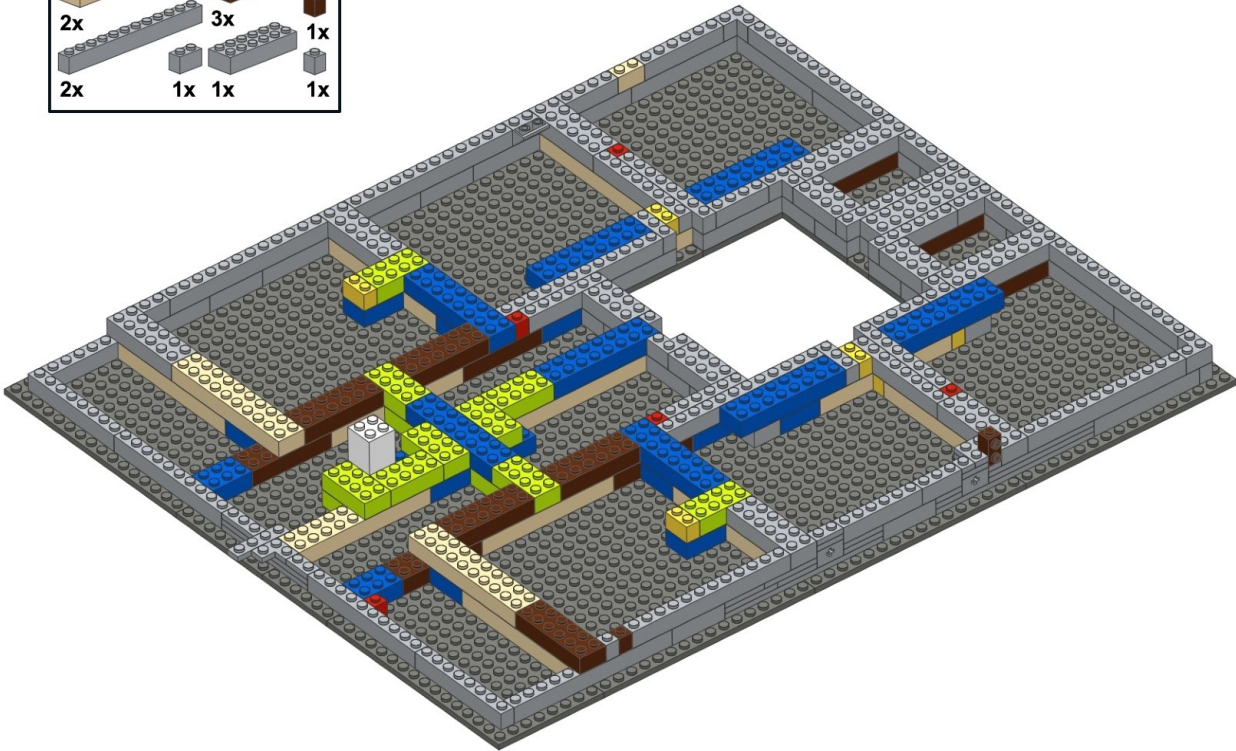
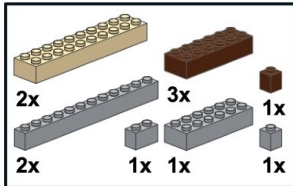







26

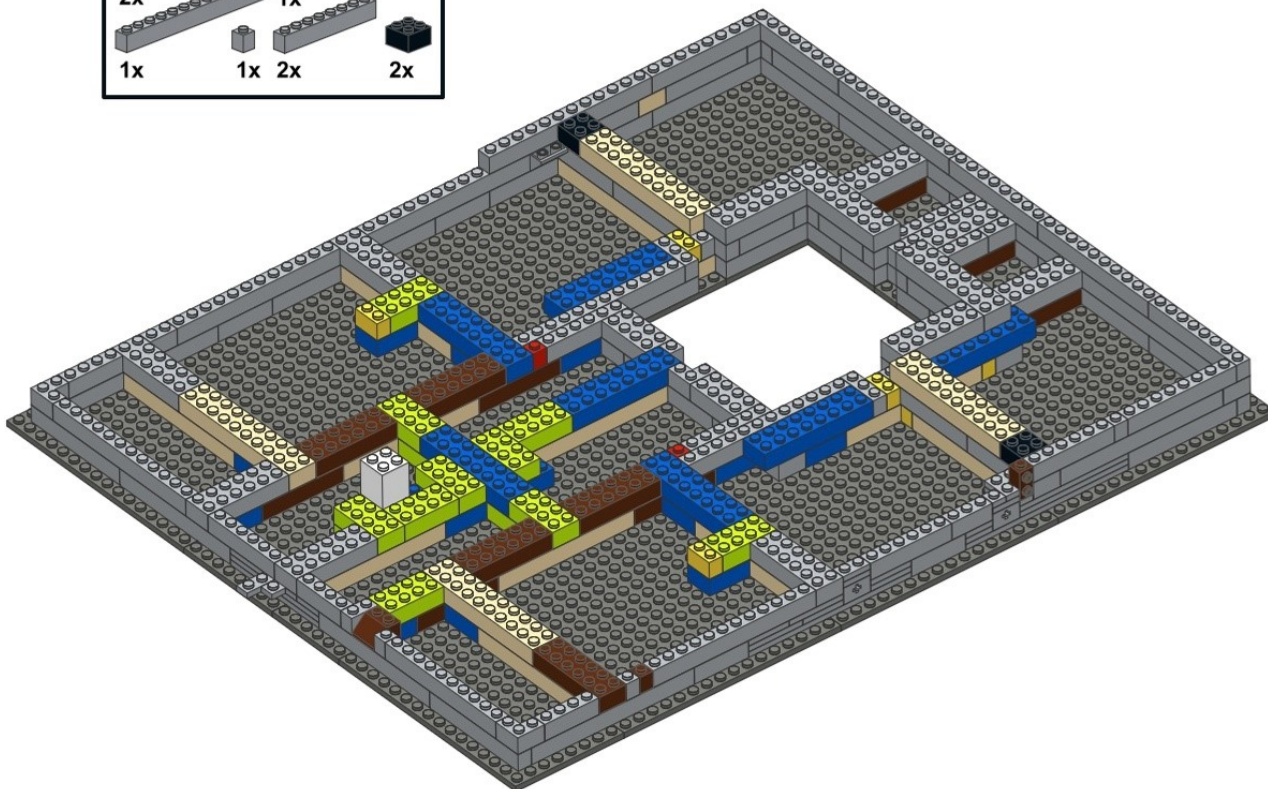
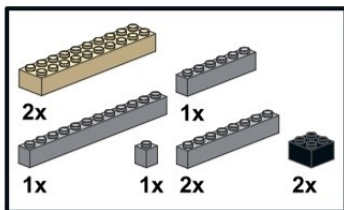

27

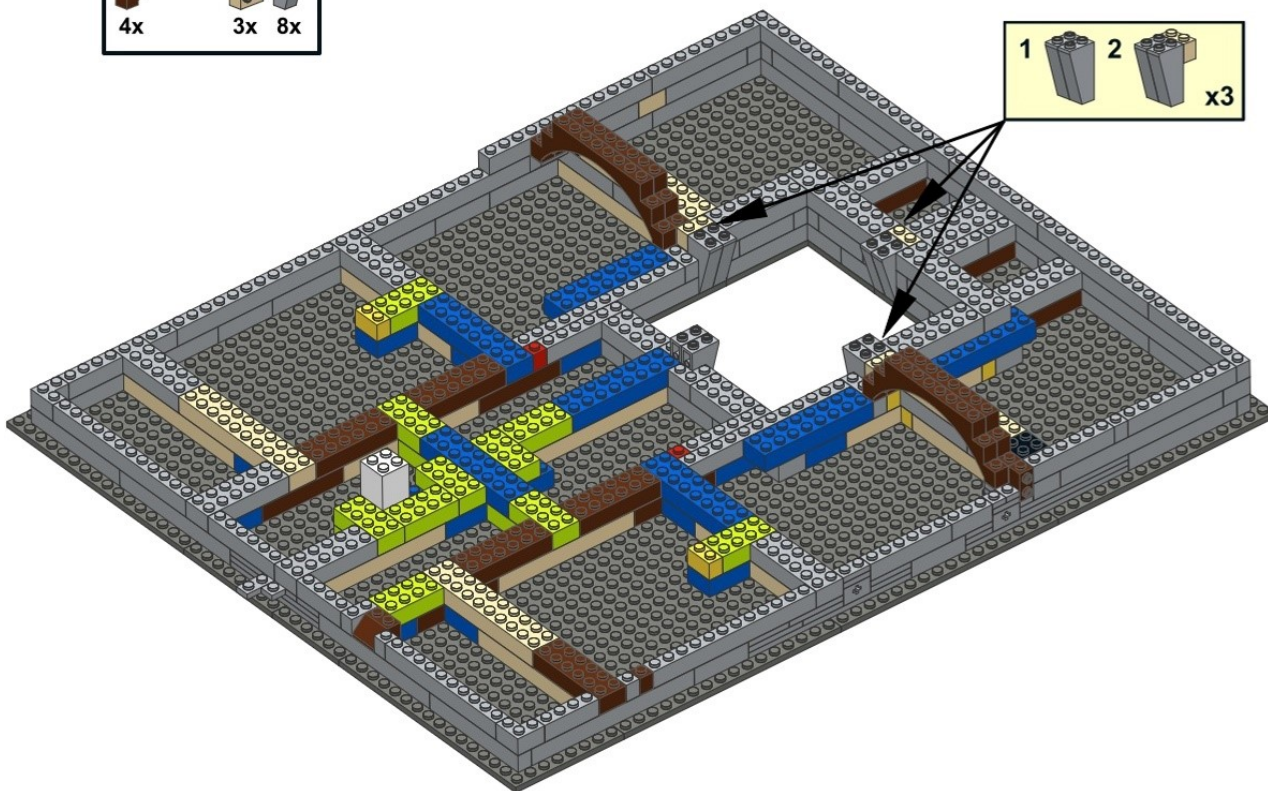
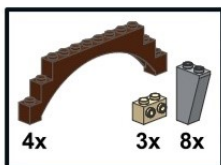



28

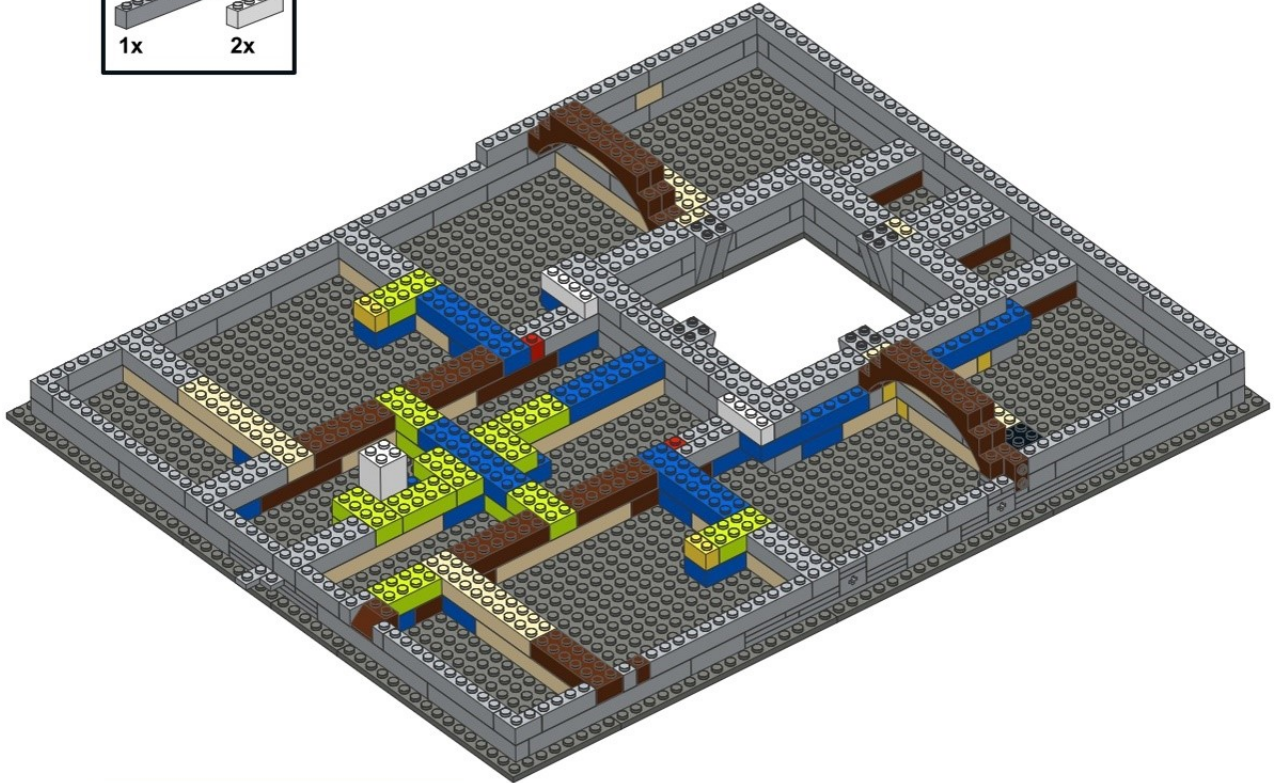
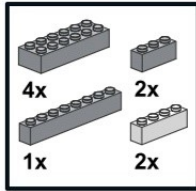

29

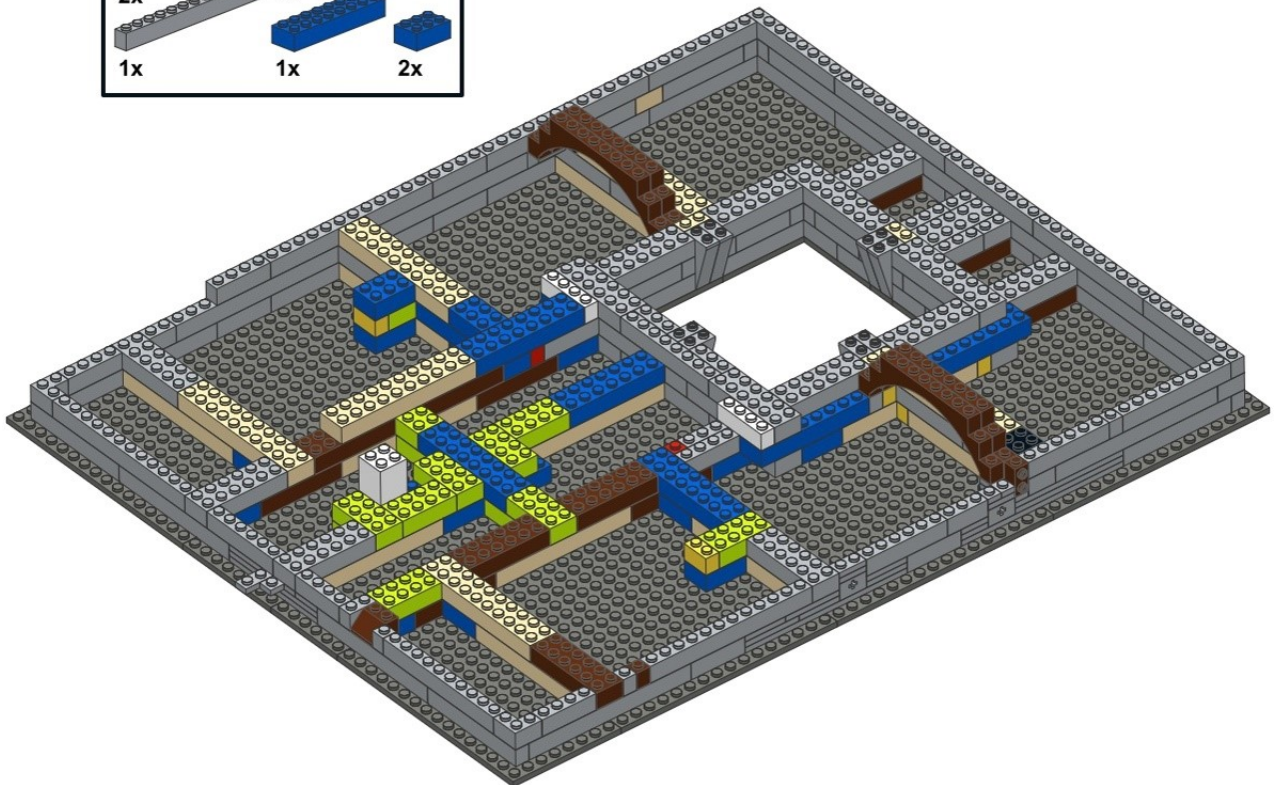
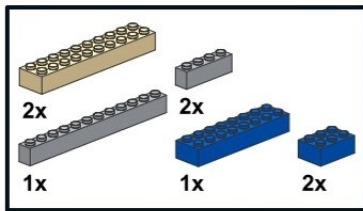



30

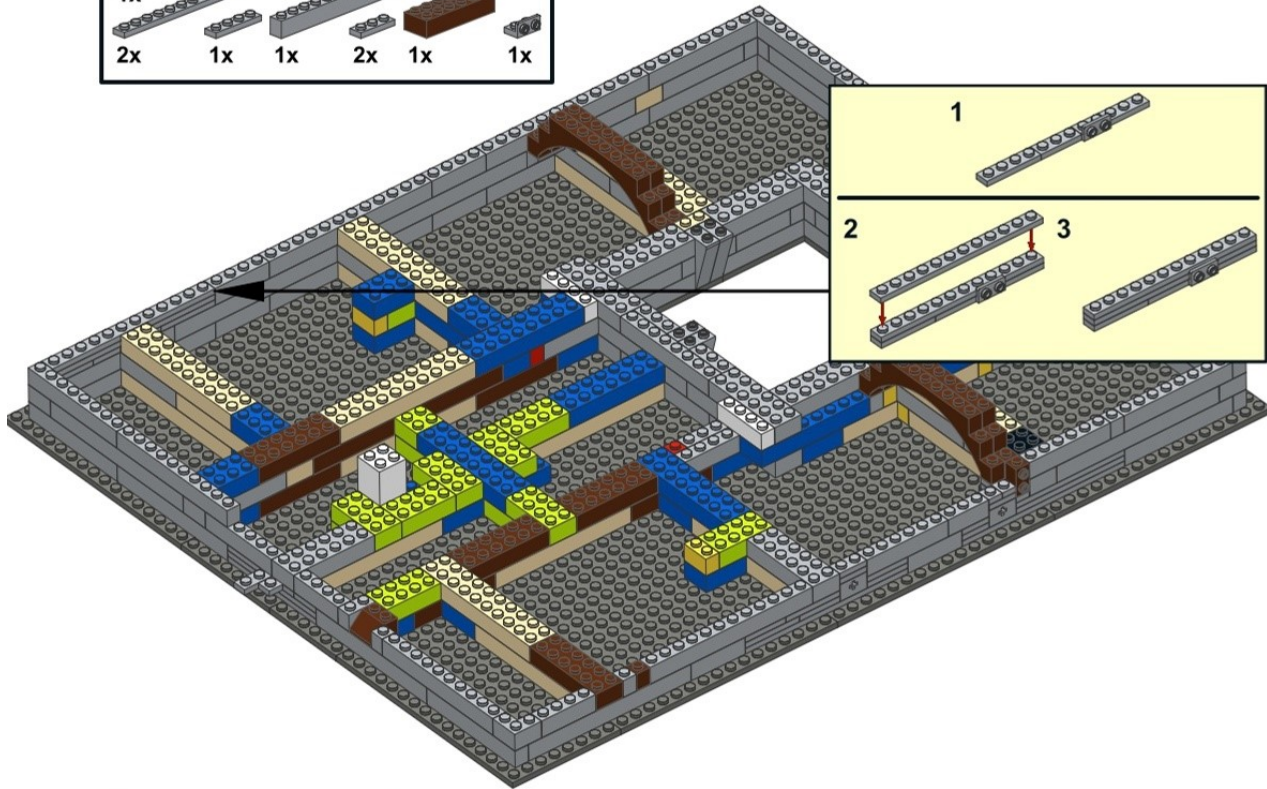
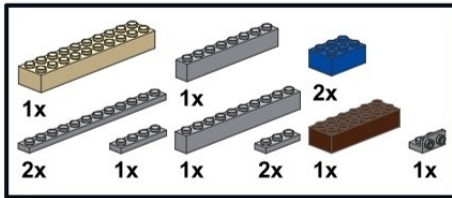

31

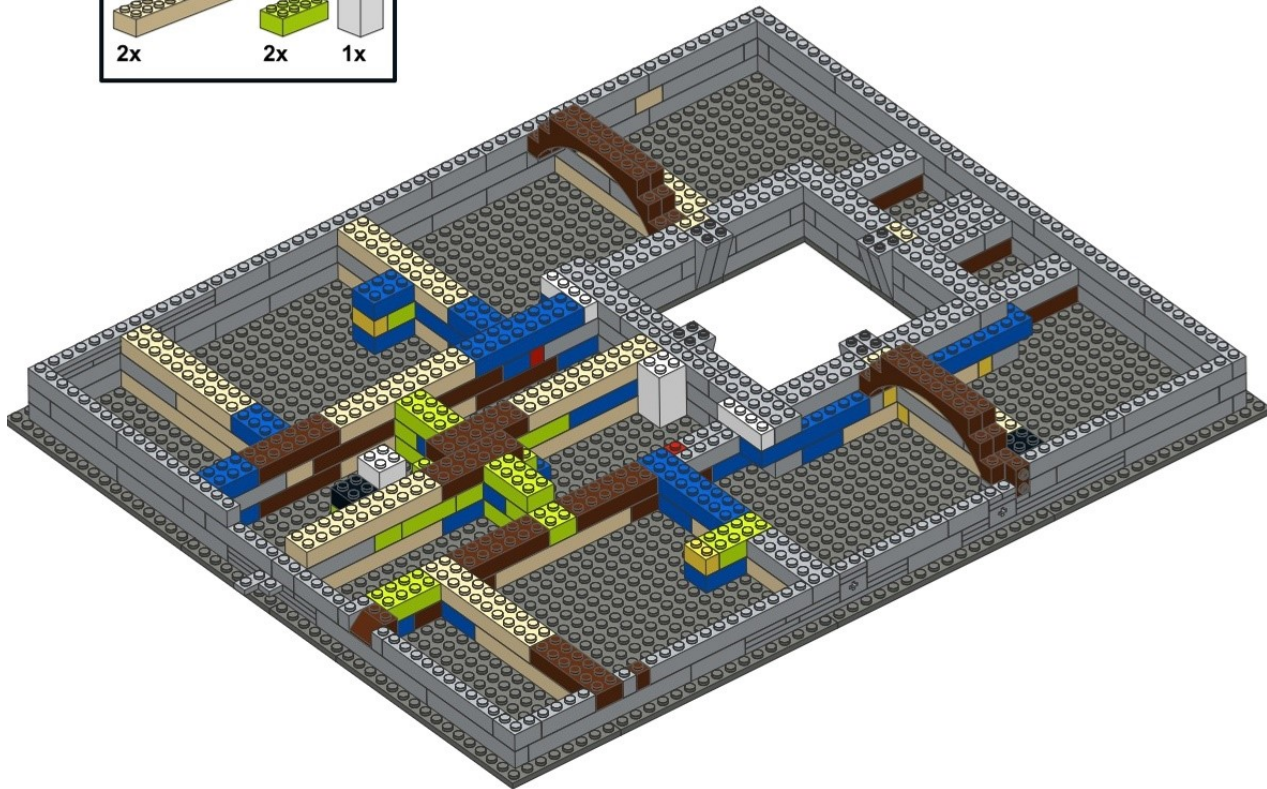
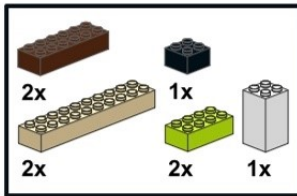



32

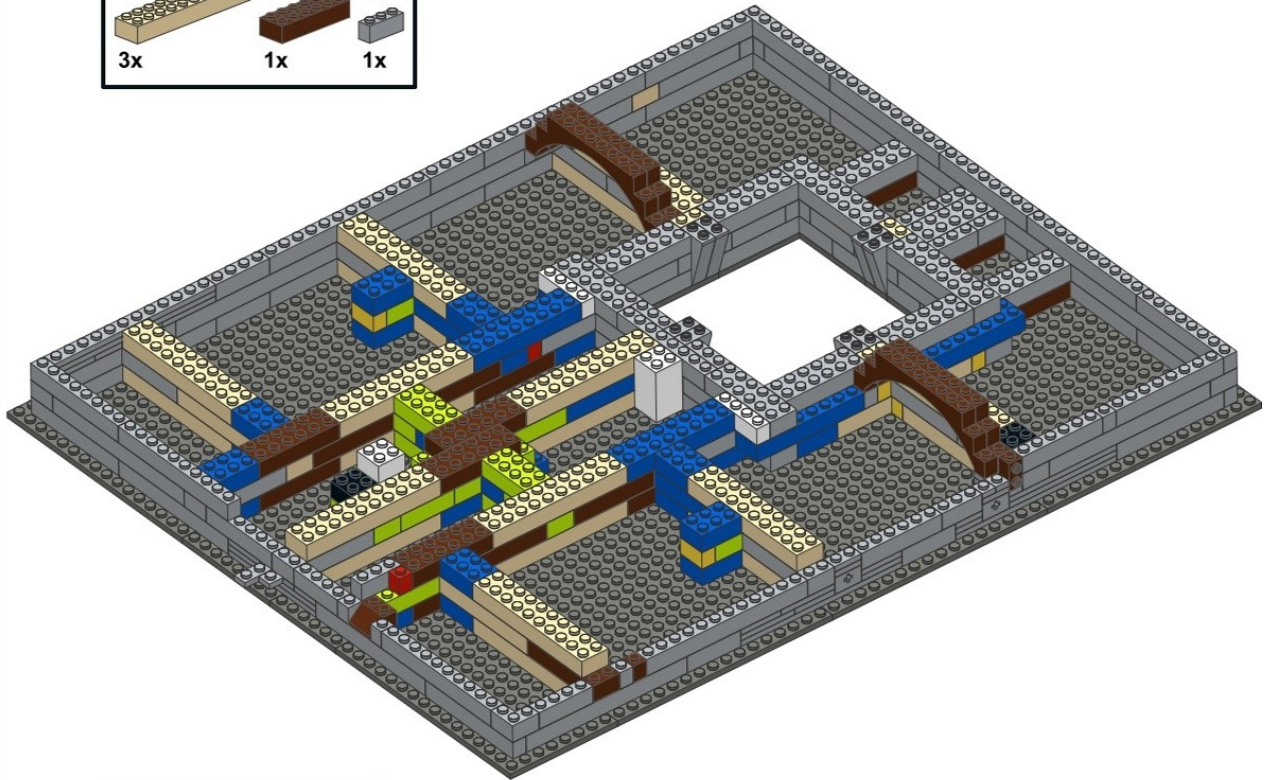
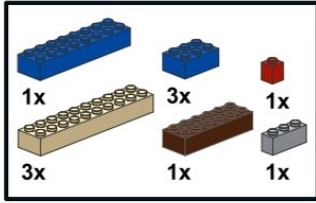

33

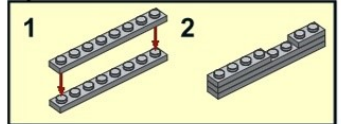
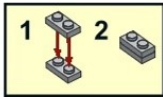
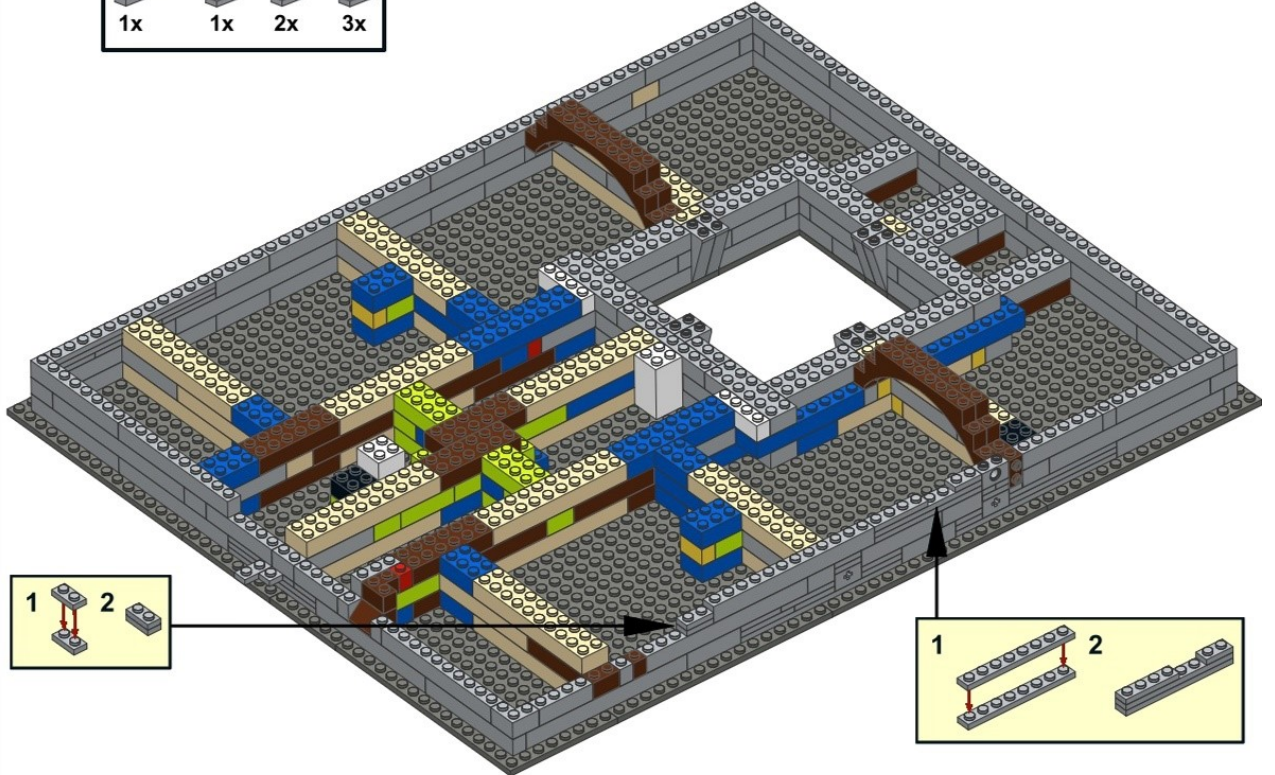
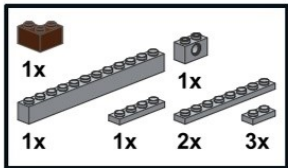



34

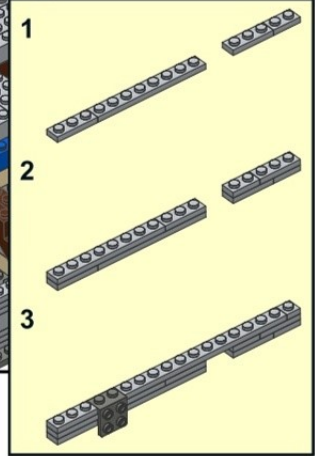
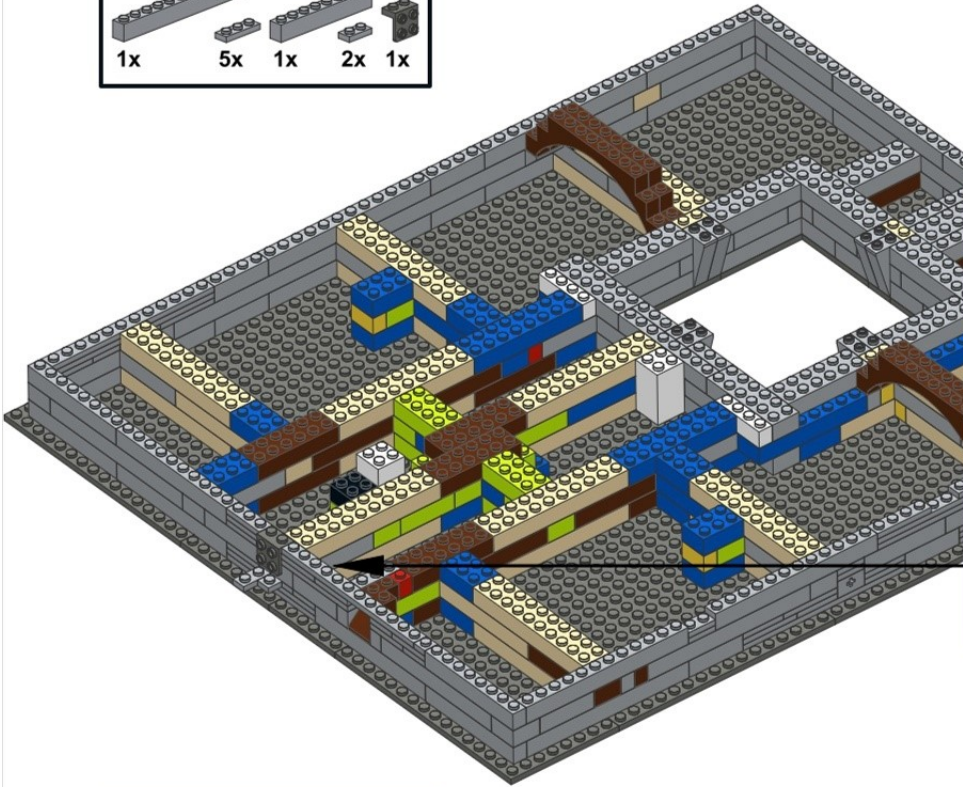
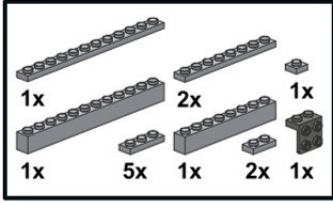

35

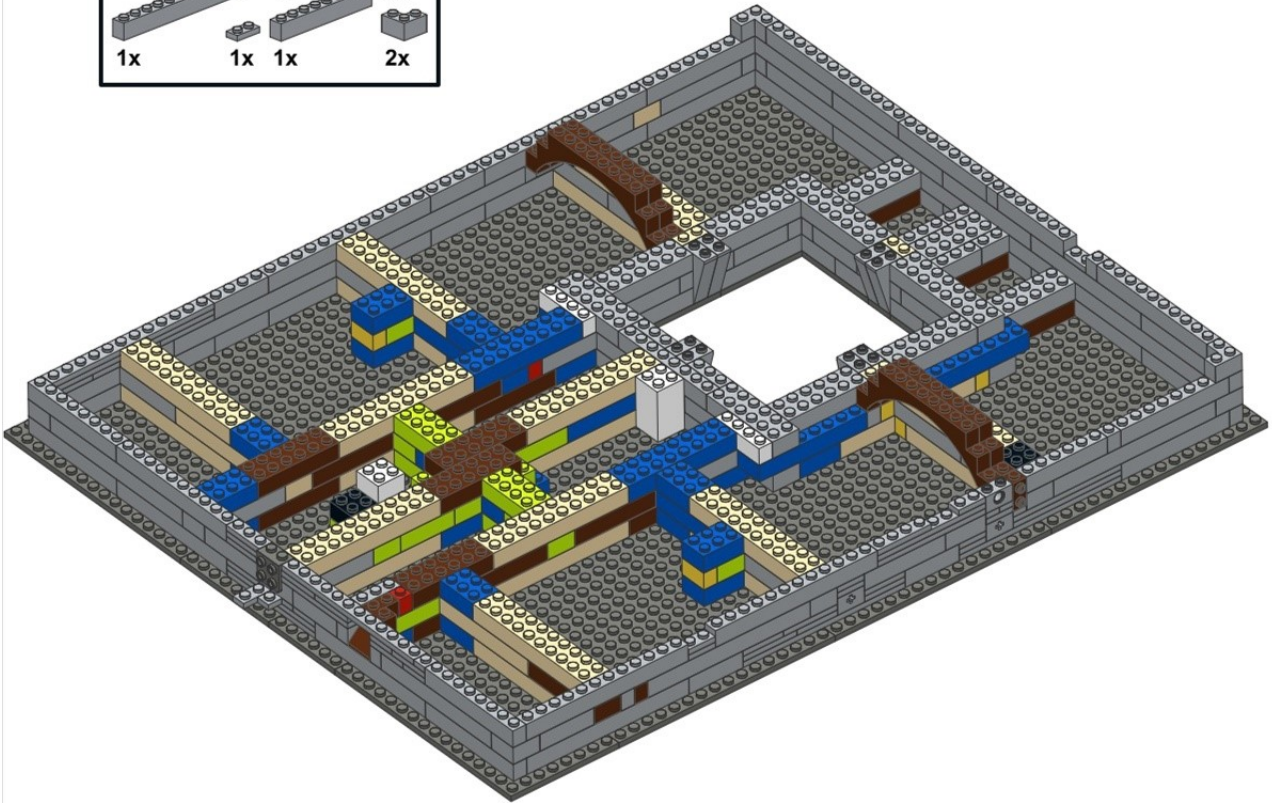
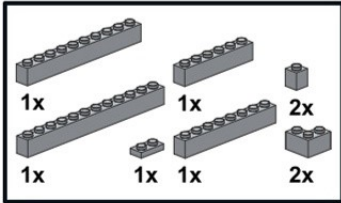



36

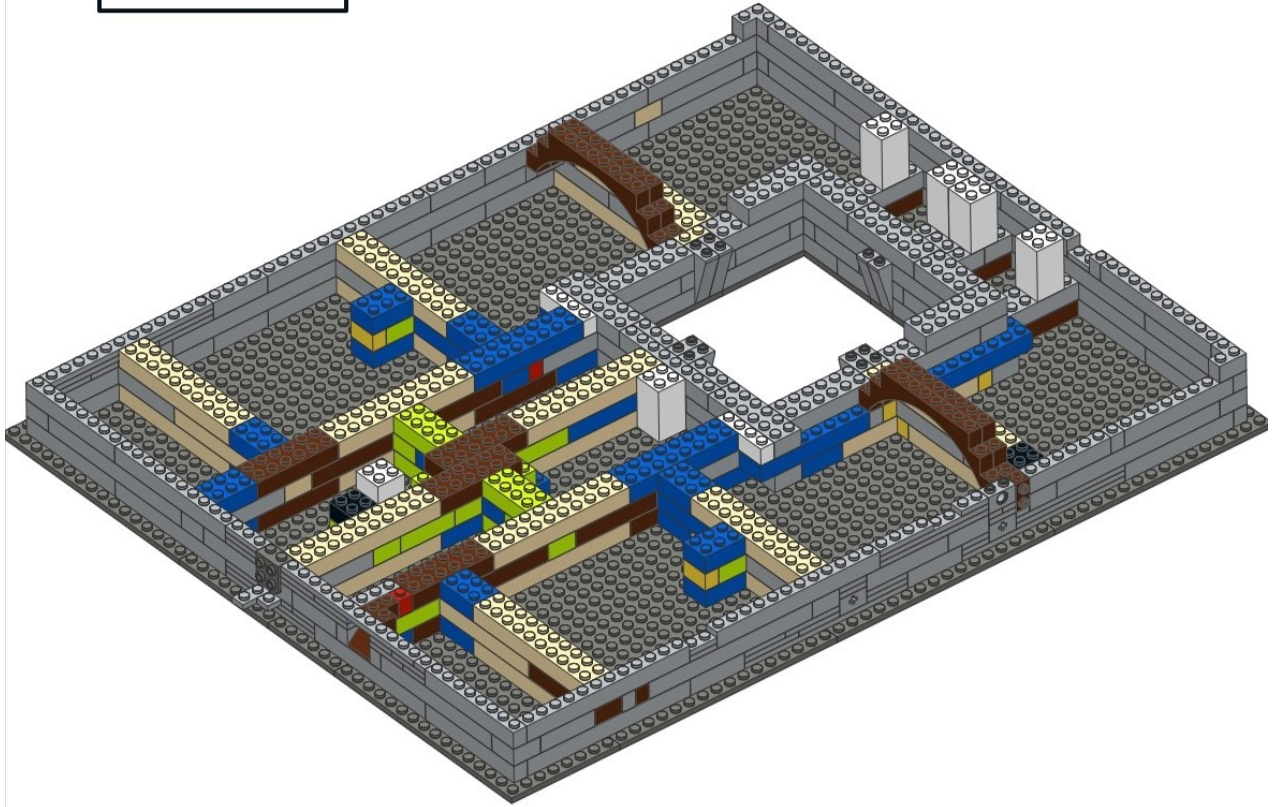
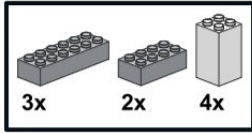

37

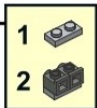
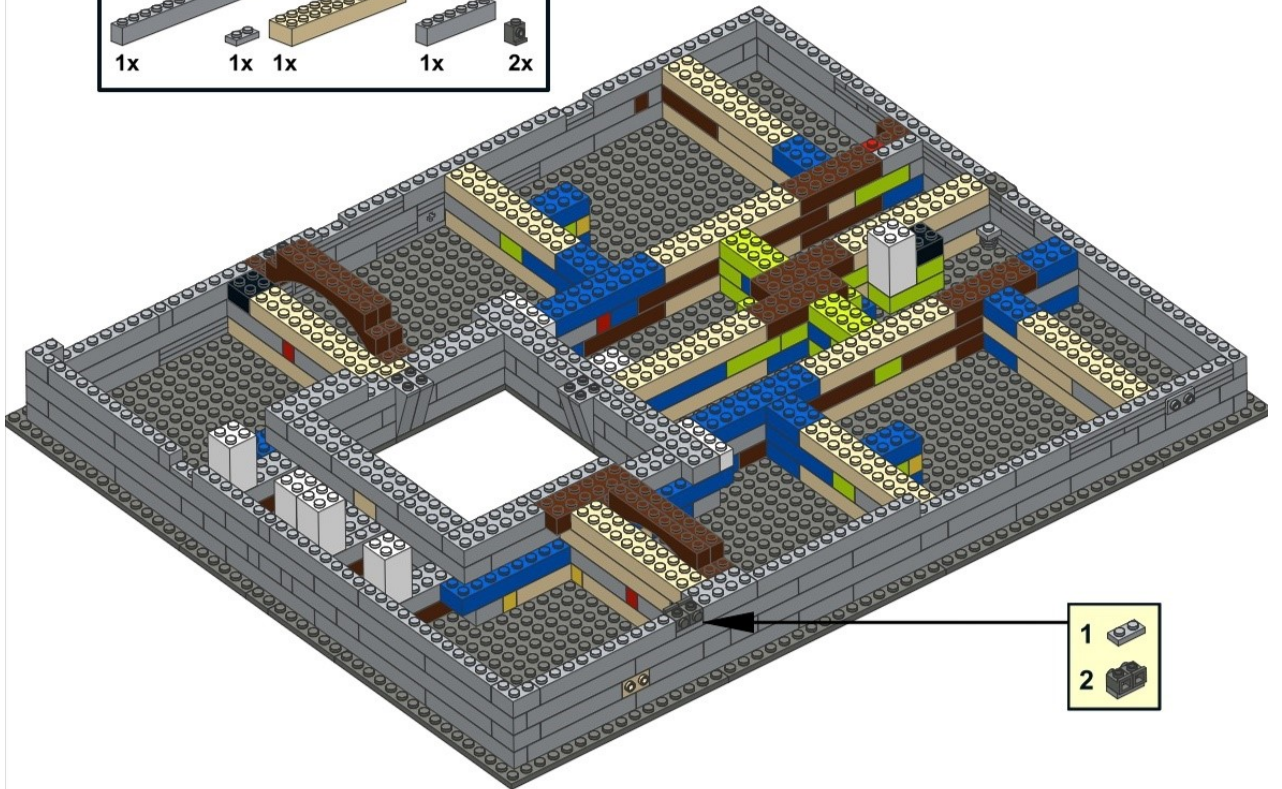
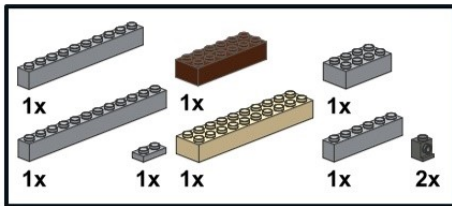



38

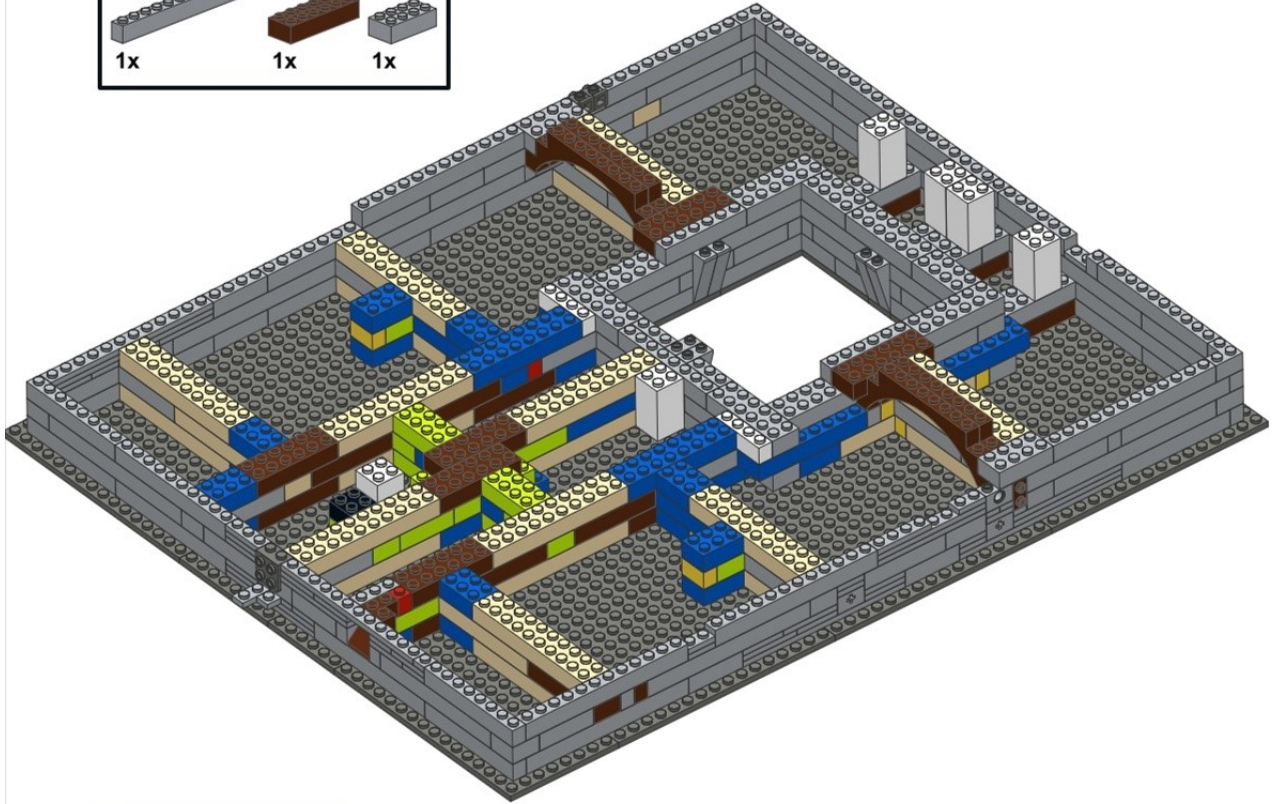
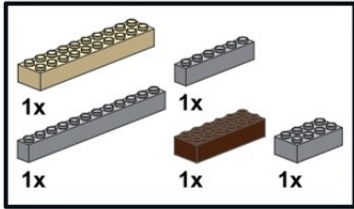

39

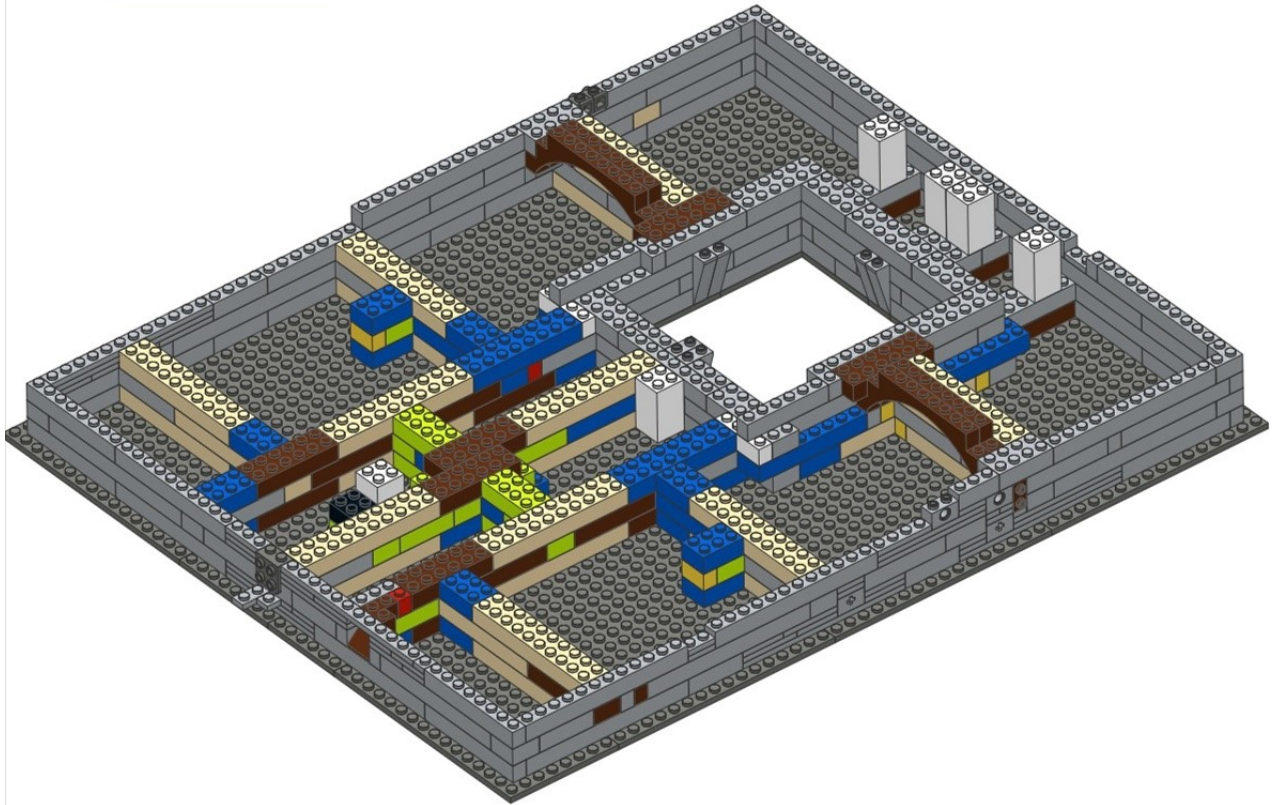
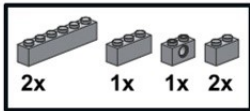



40

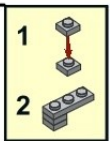
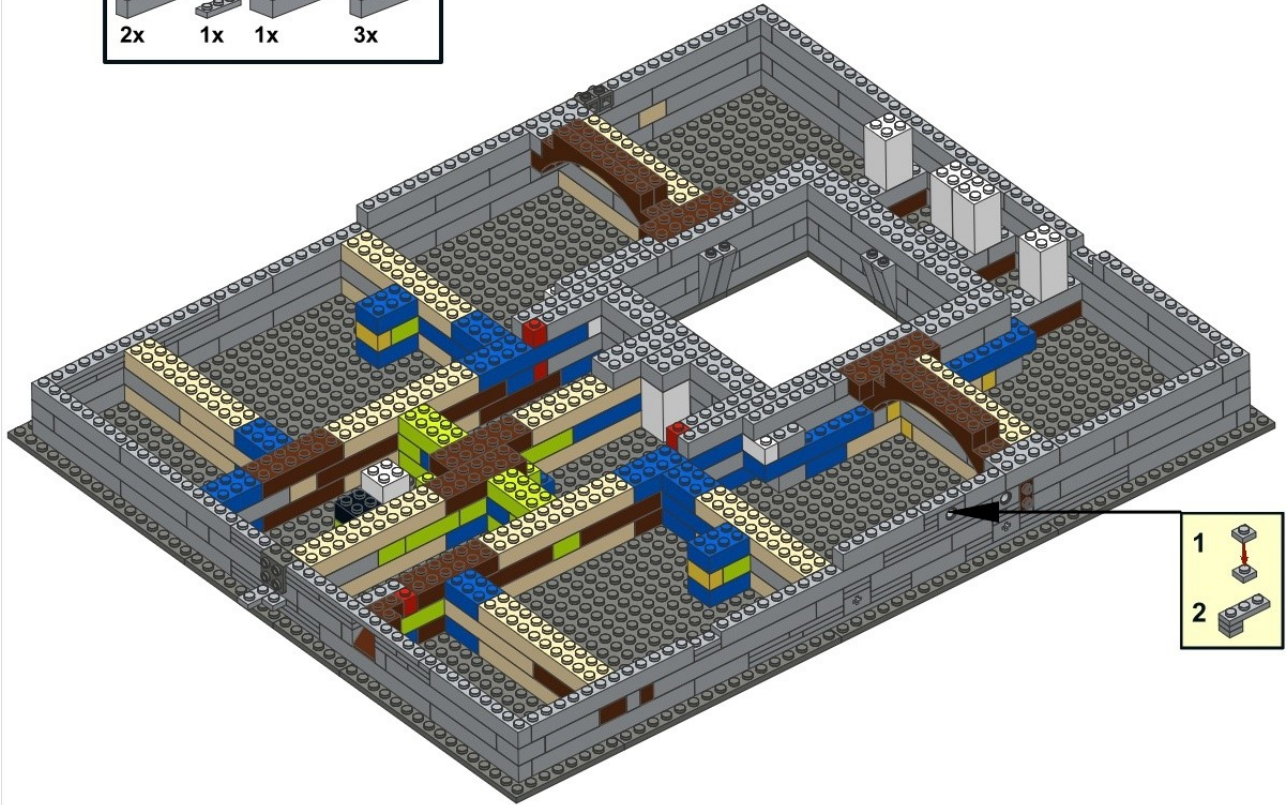
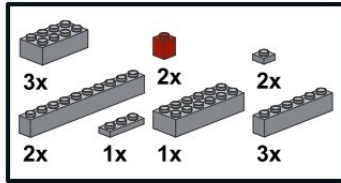

41

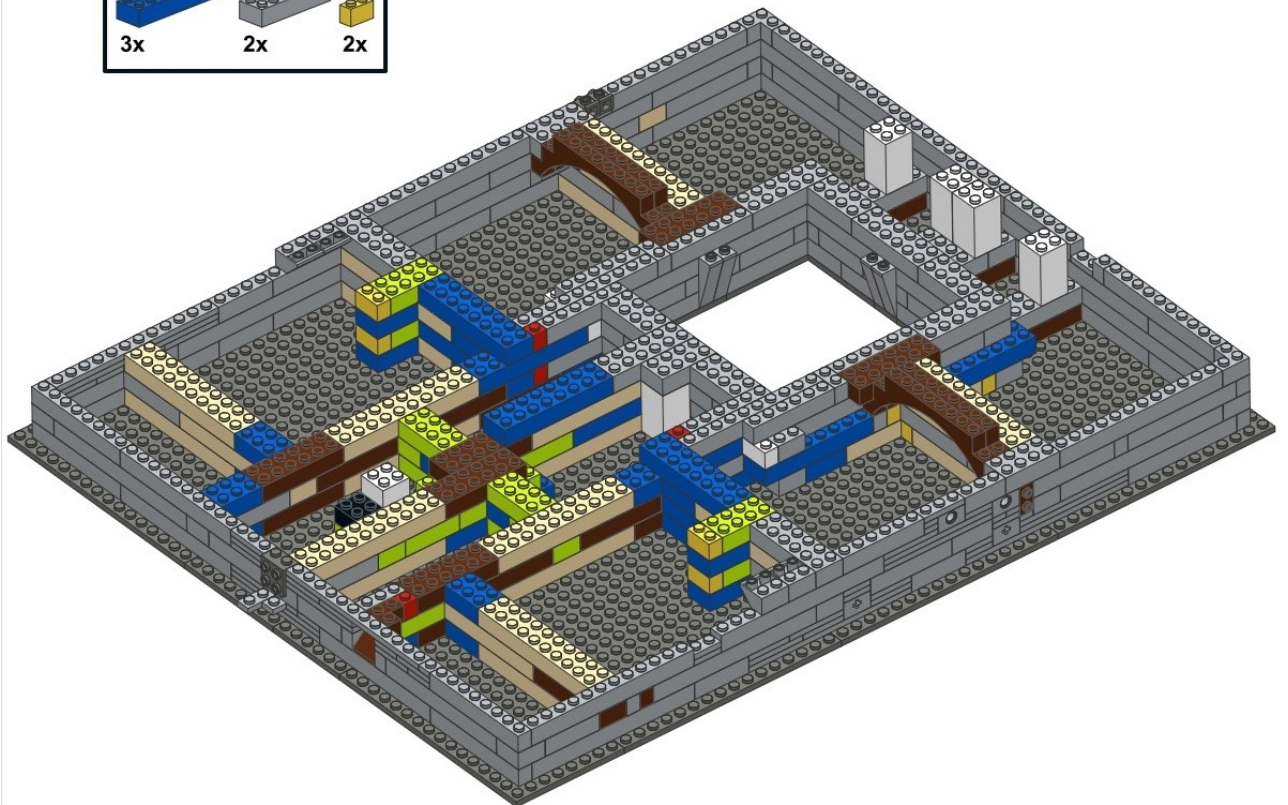
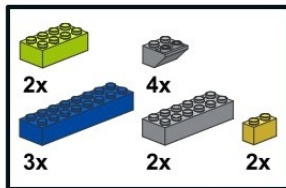



42

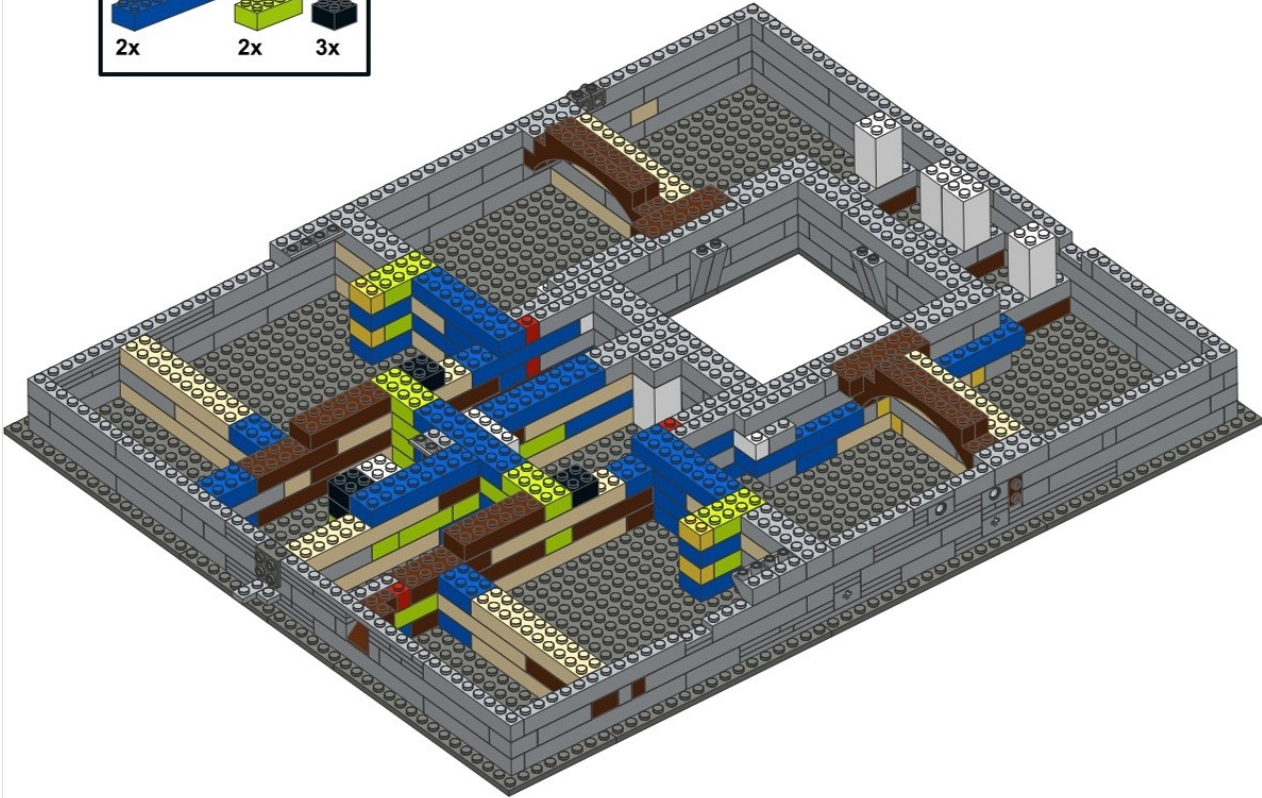
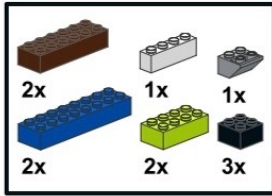

43

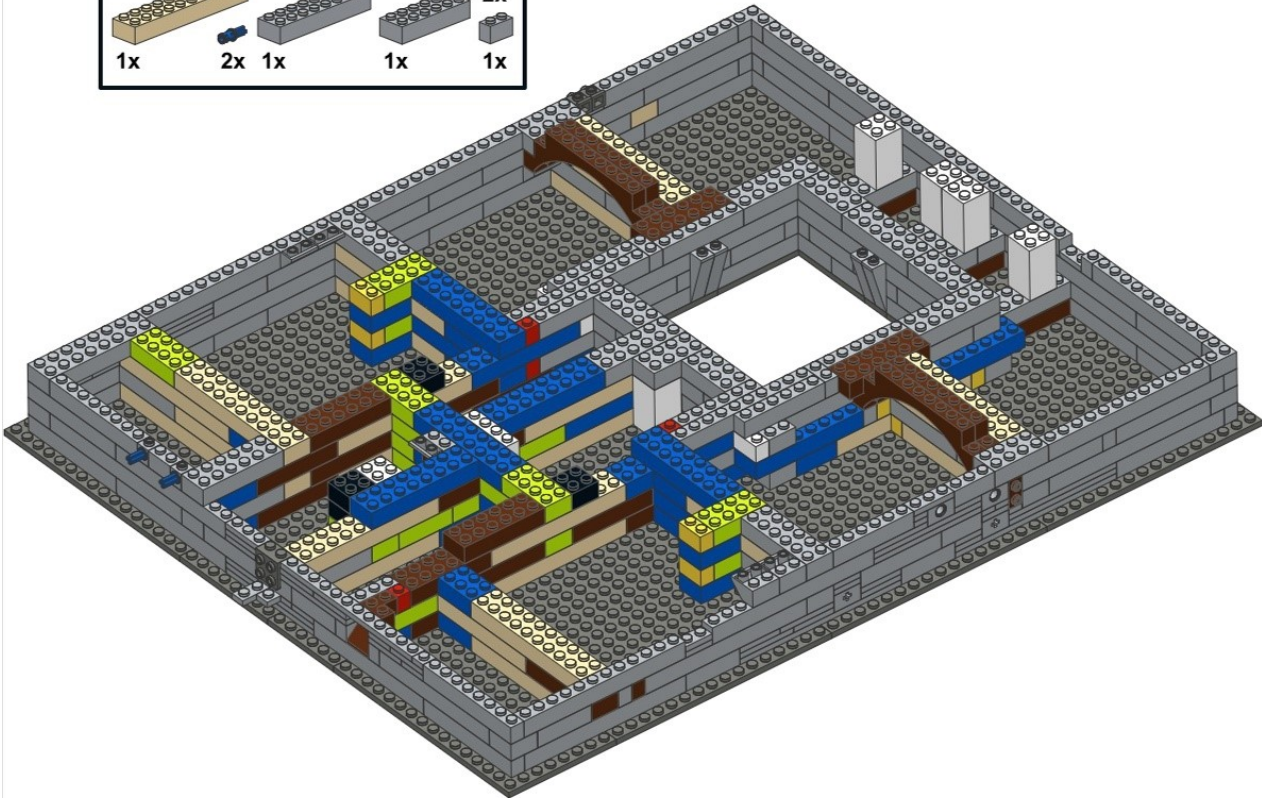
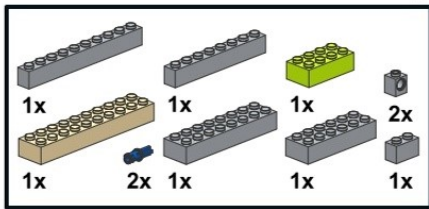



44

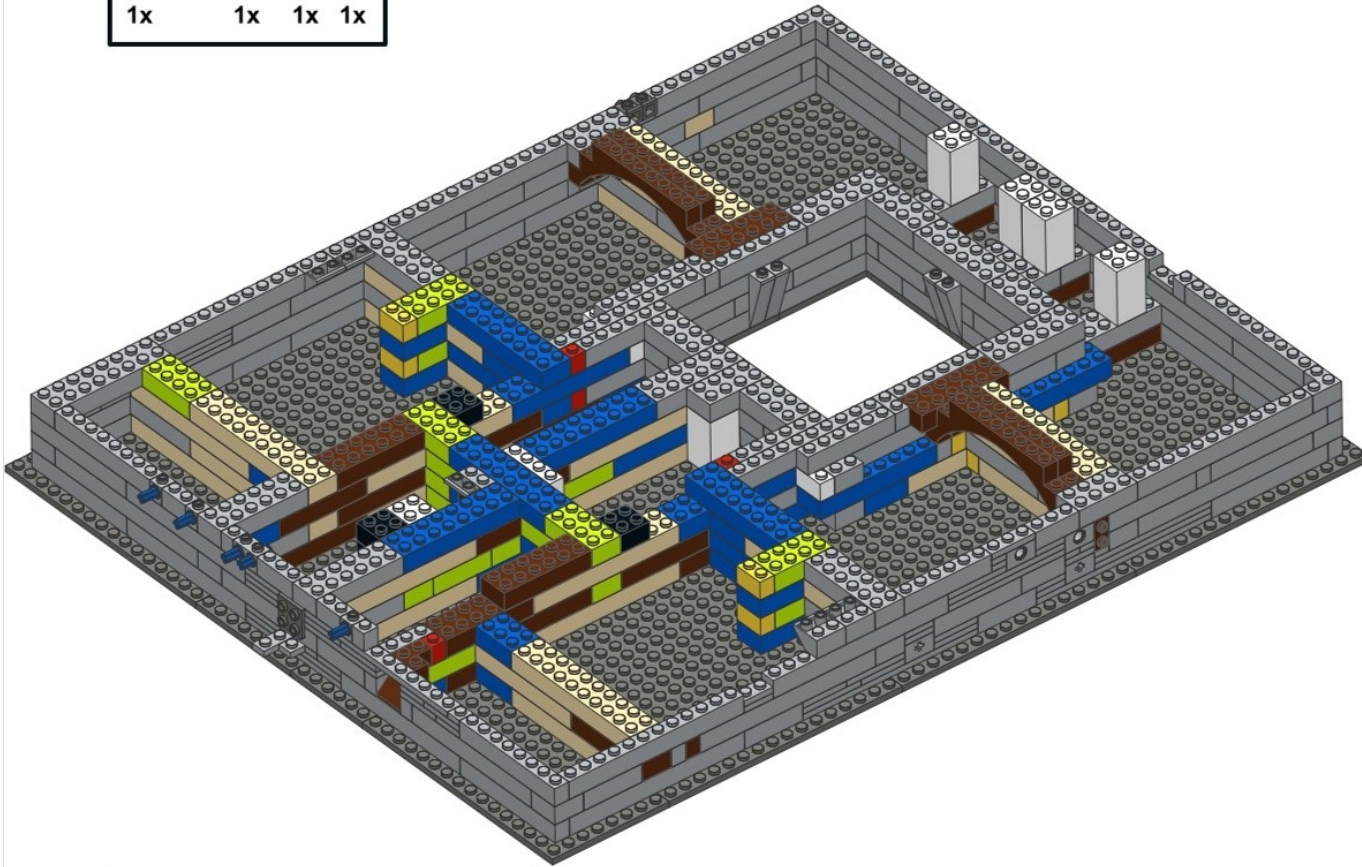
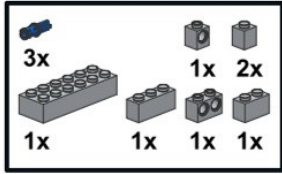

45

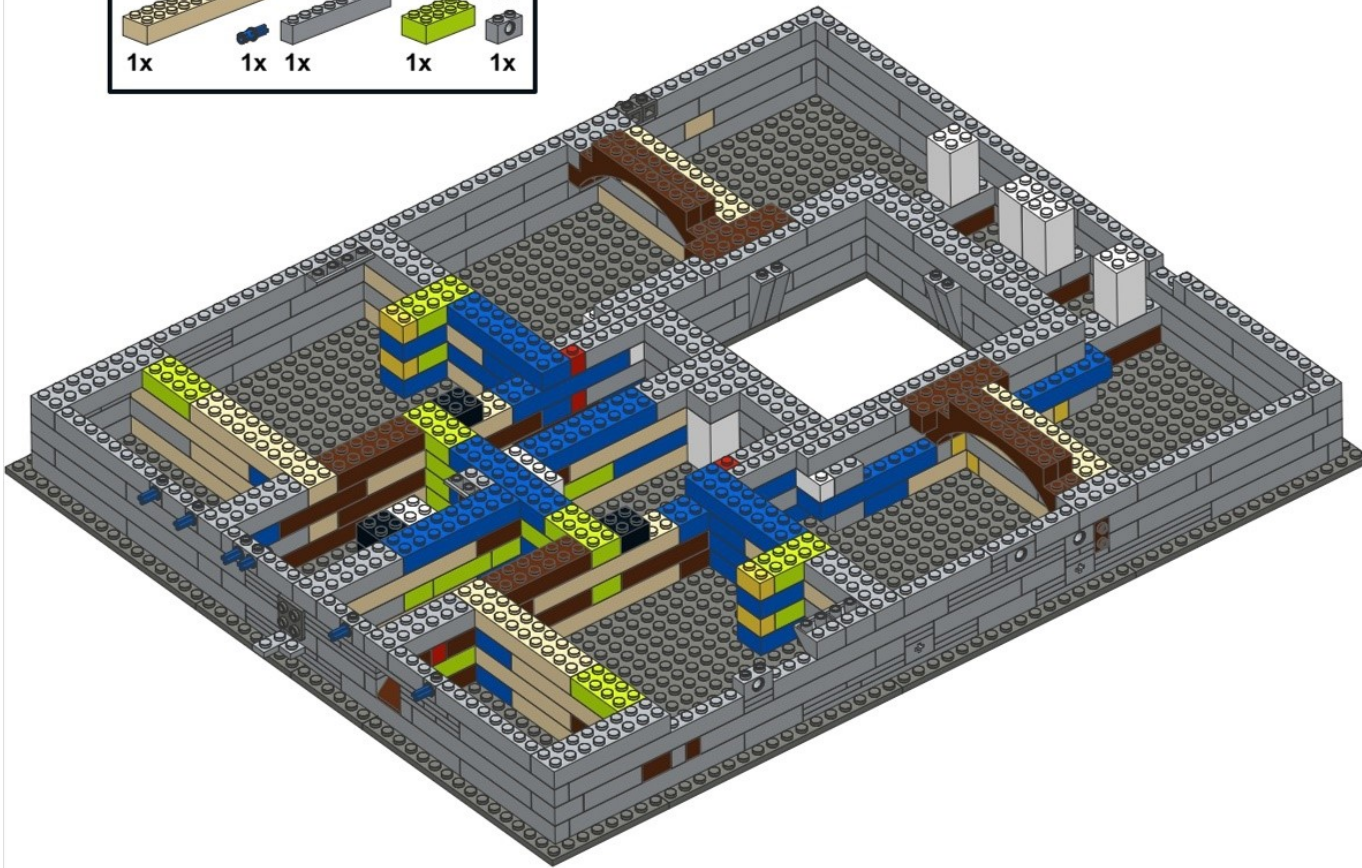
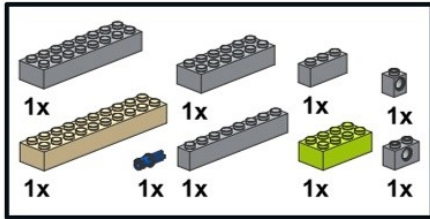



46

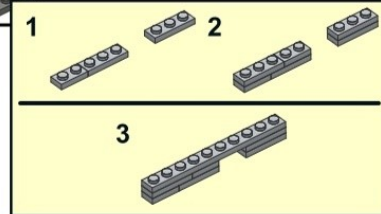
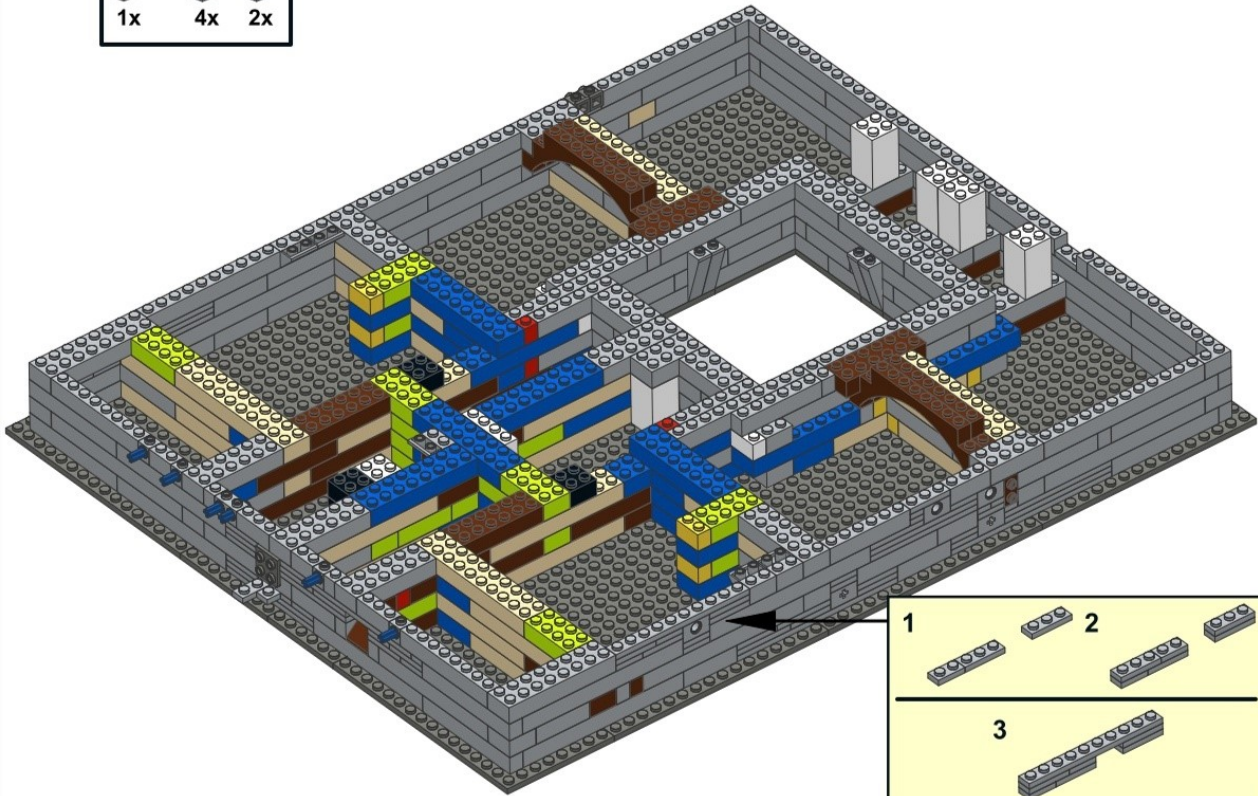
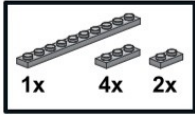

47

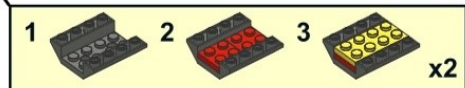
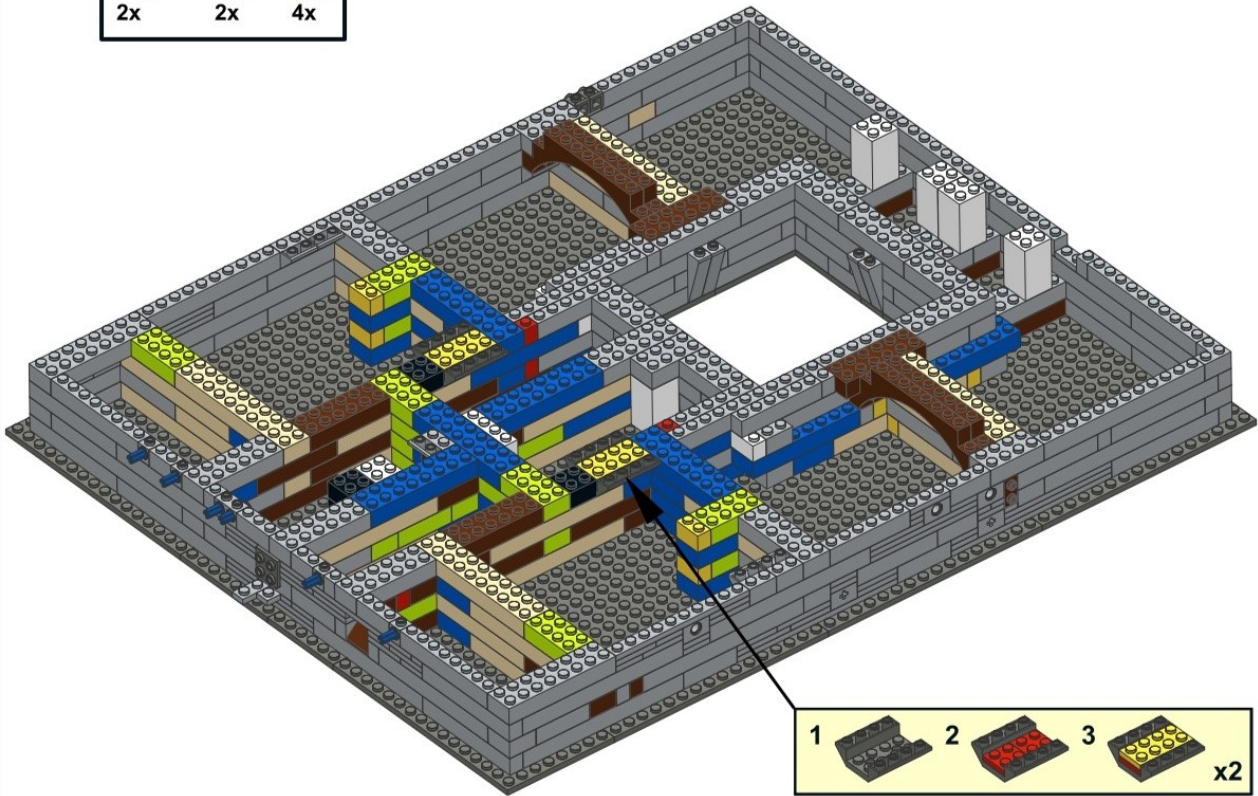
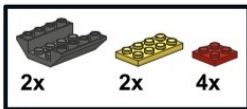



48

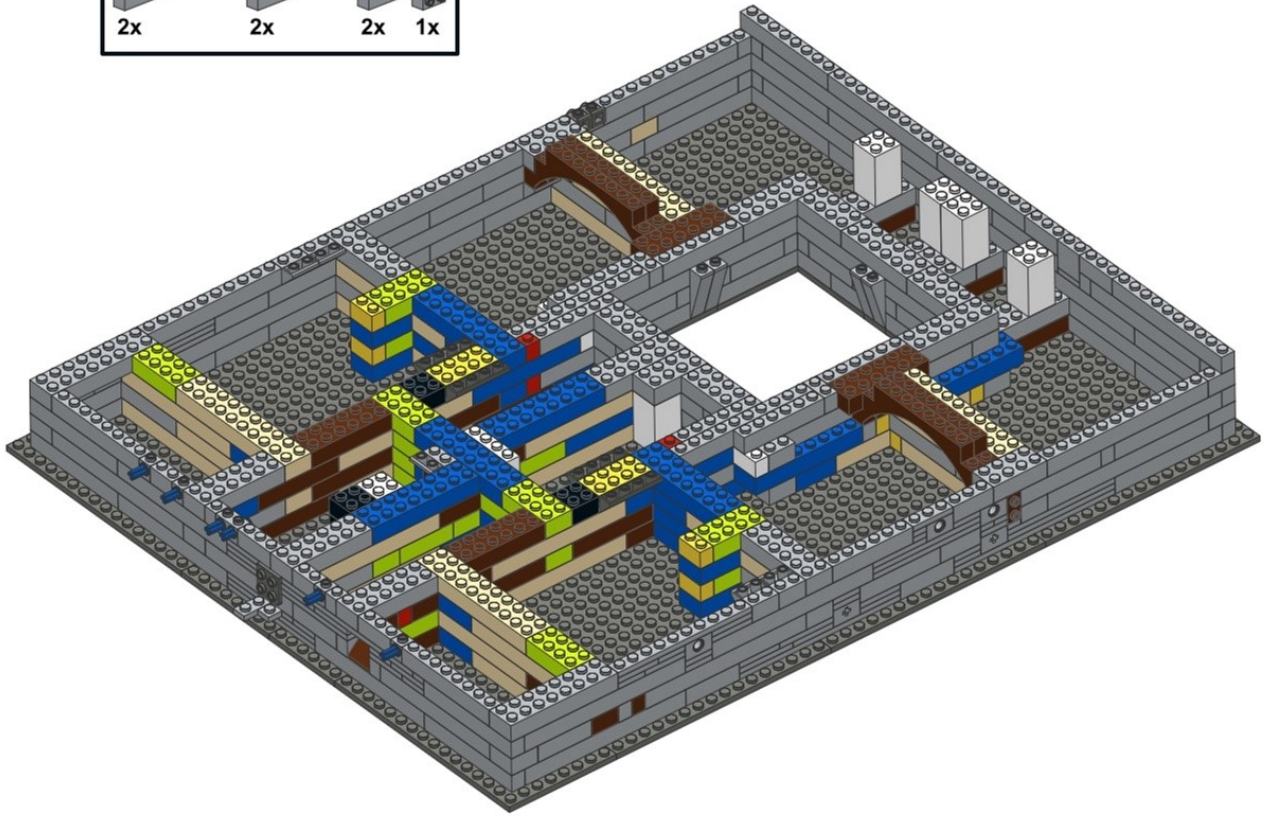
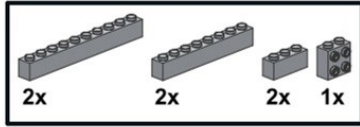

49

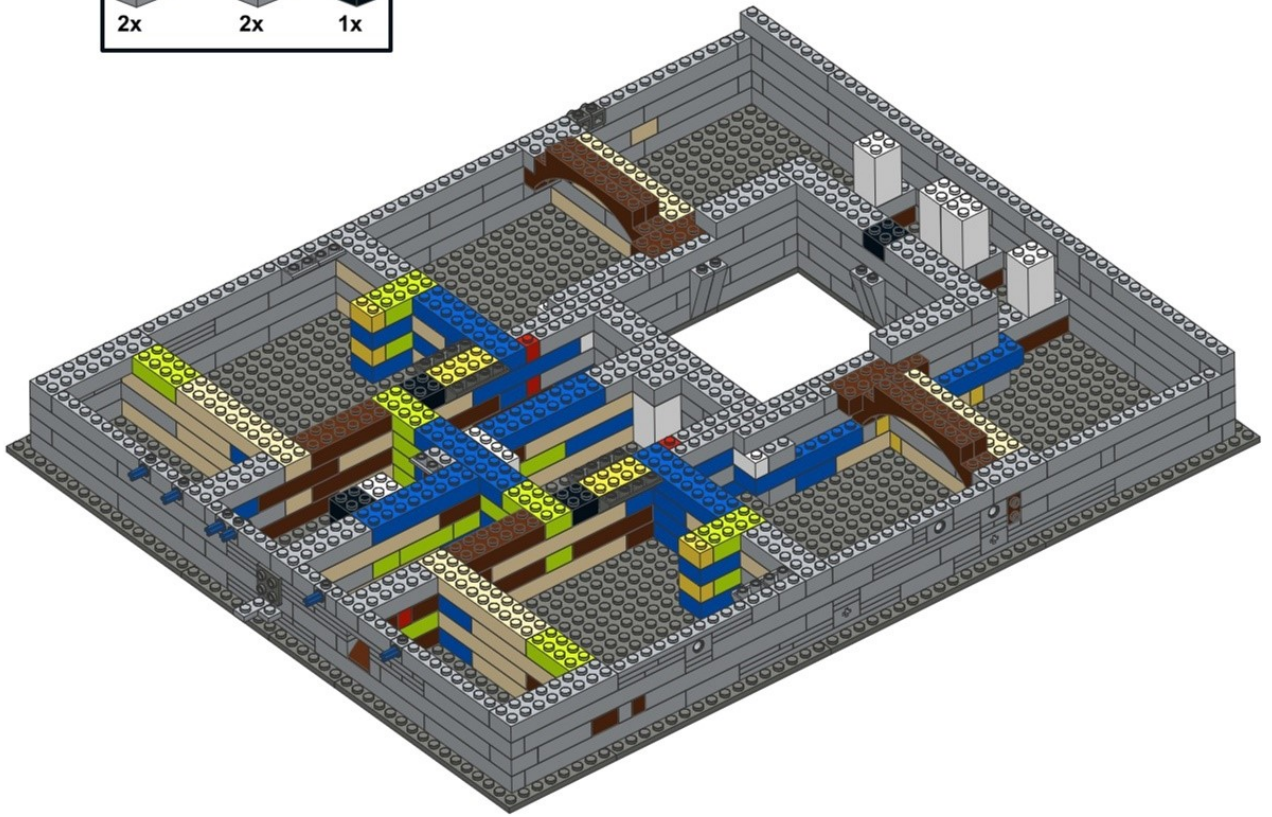
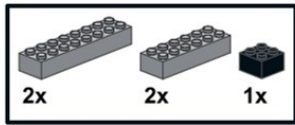



50

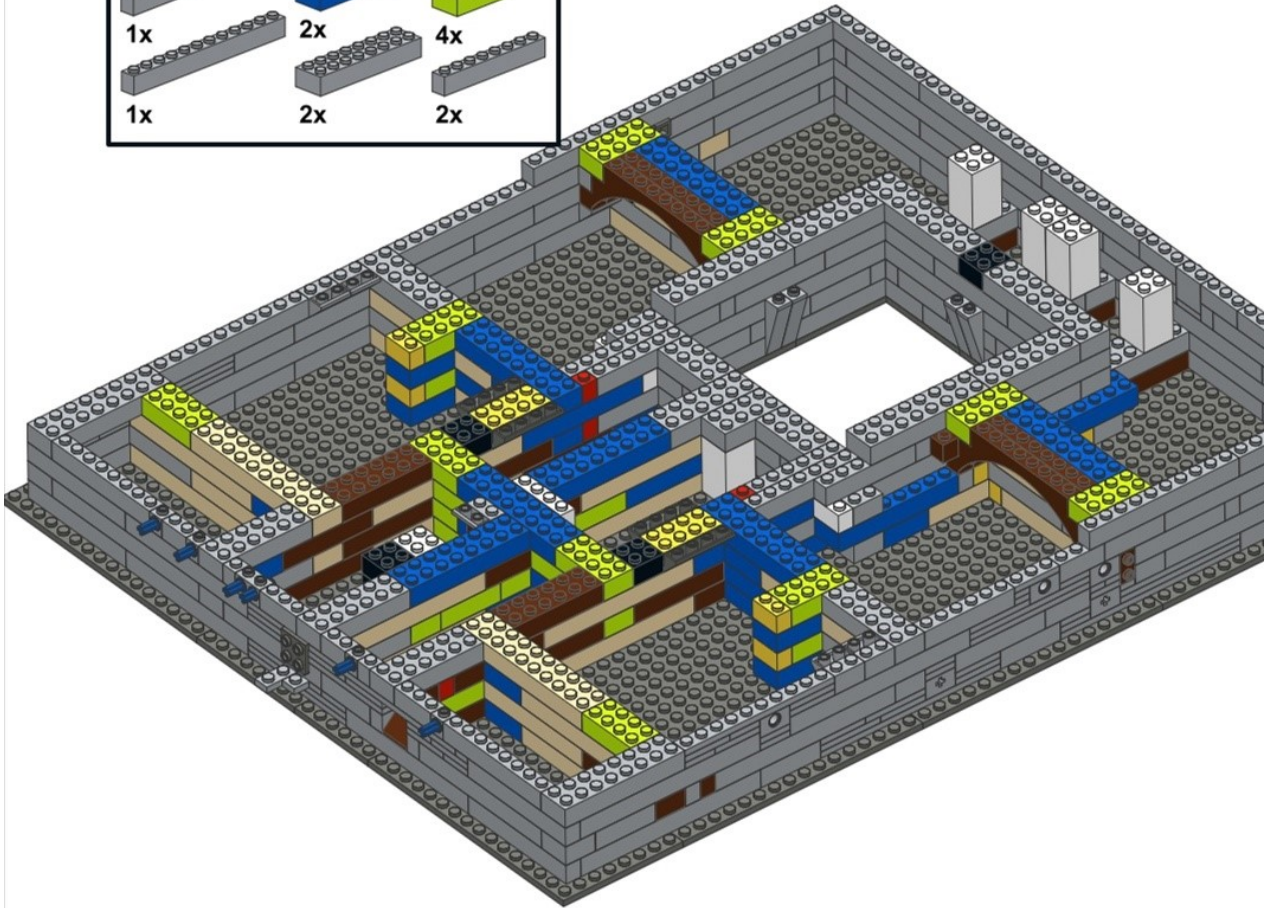
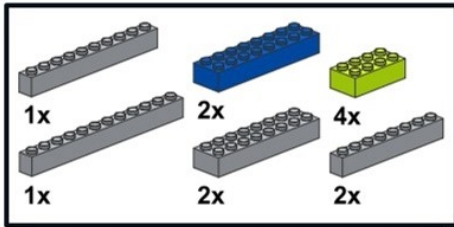

51

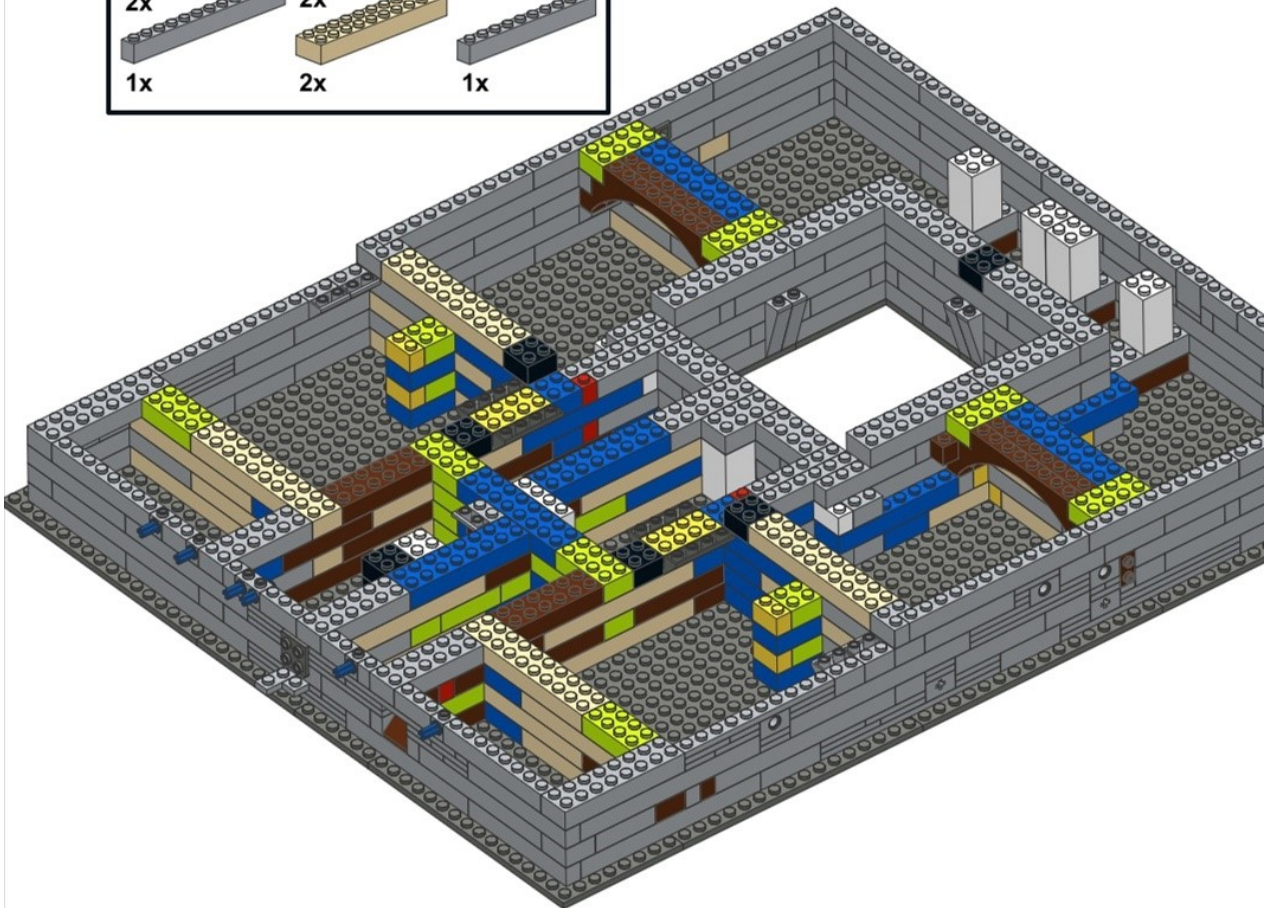
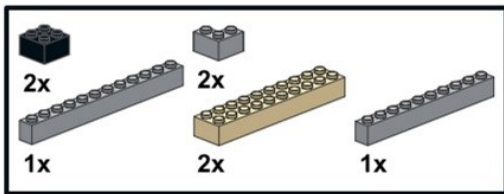



52

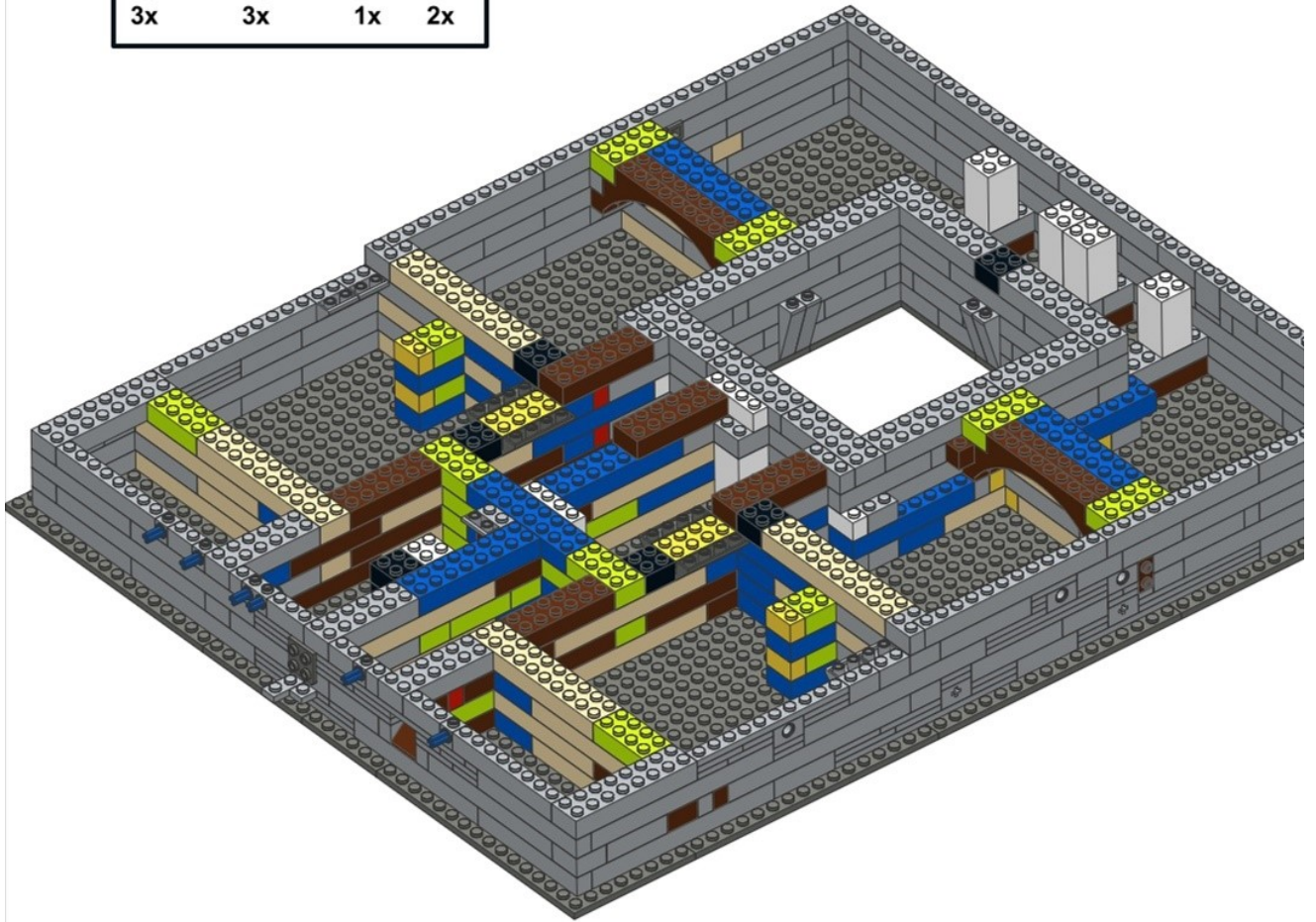
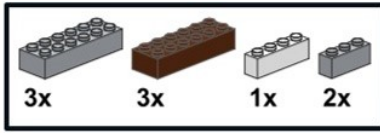

53

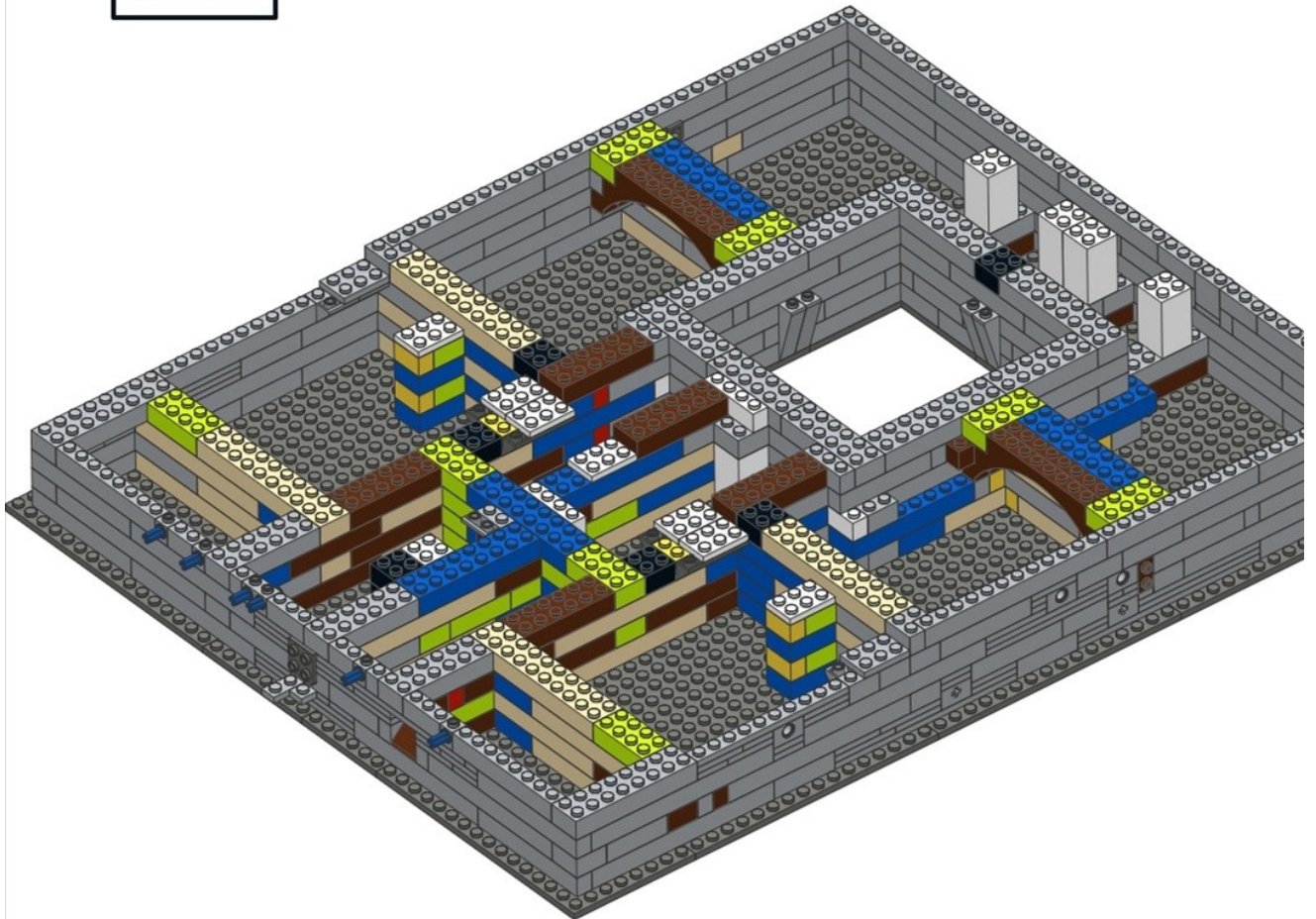
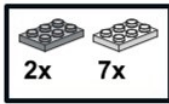



54

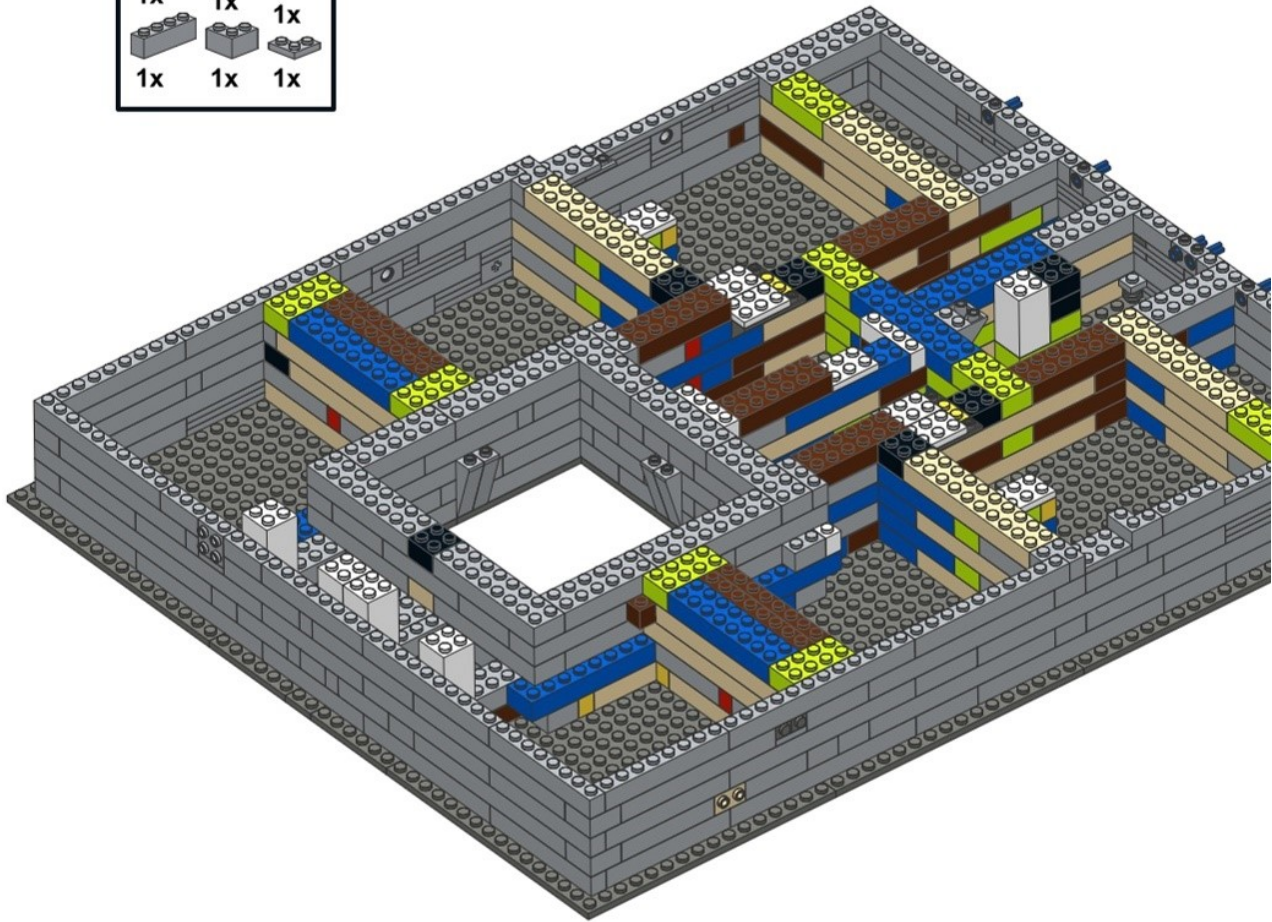
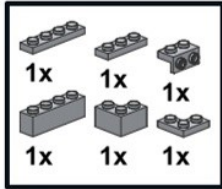

55

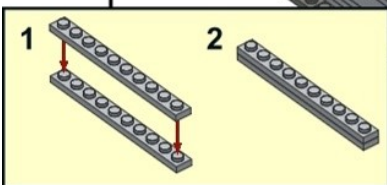
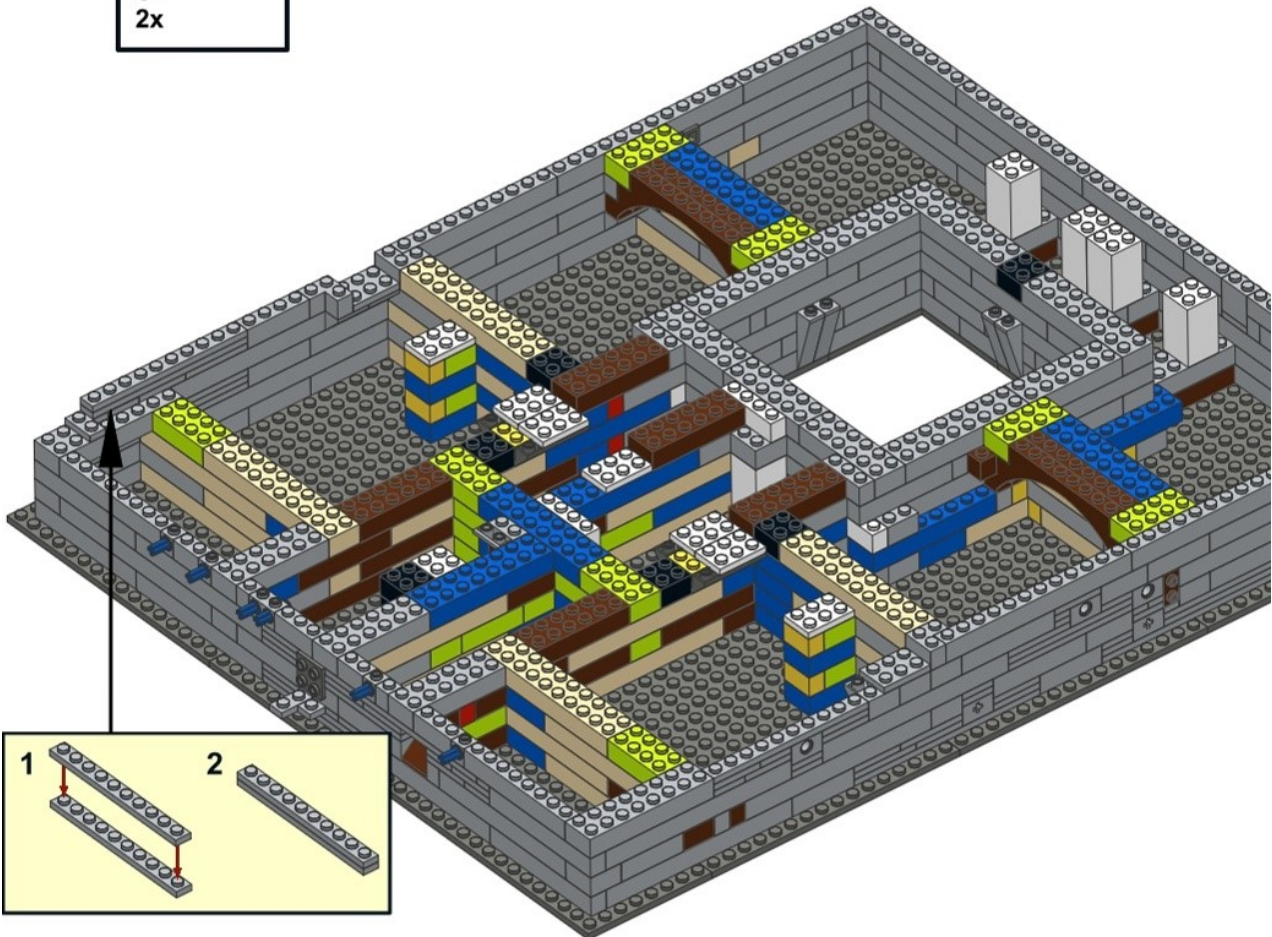
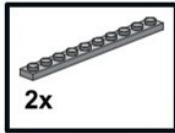



56

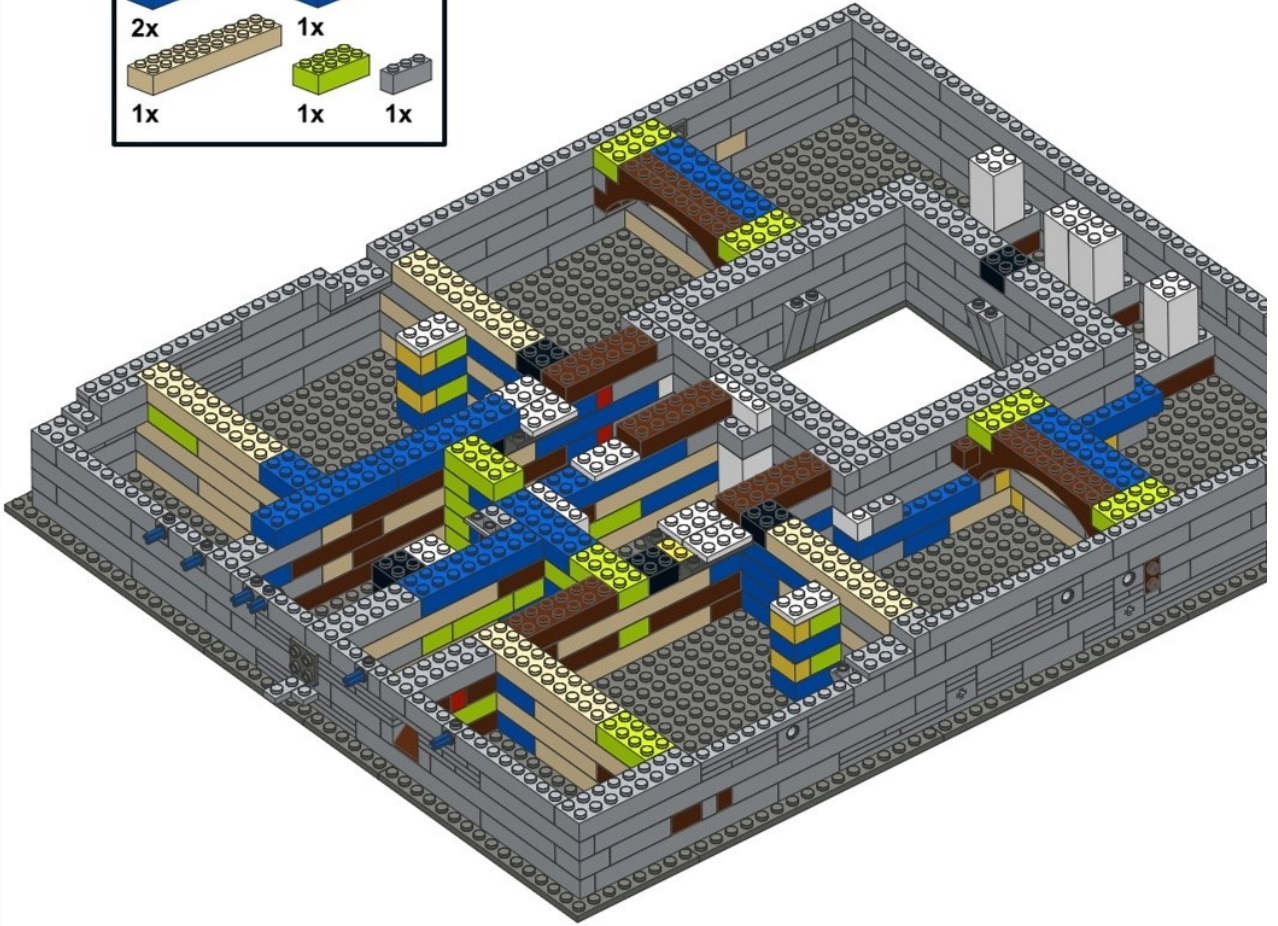
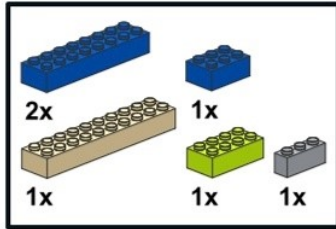

57

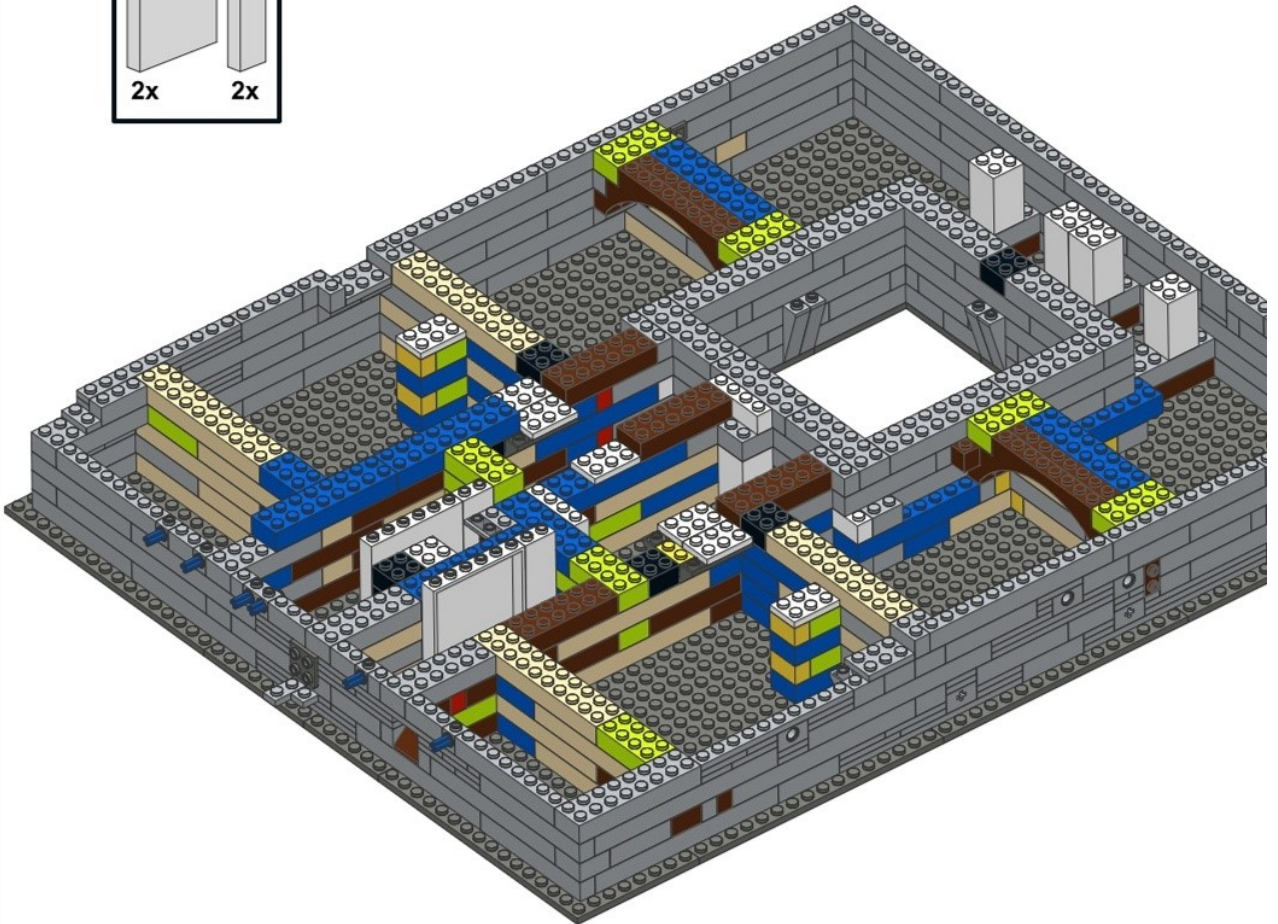
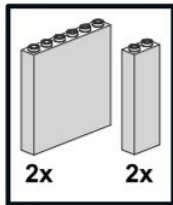



58

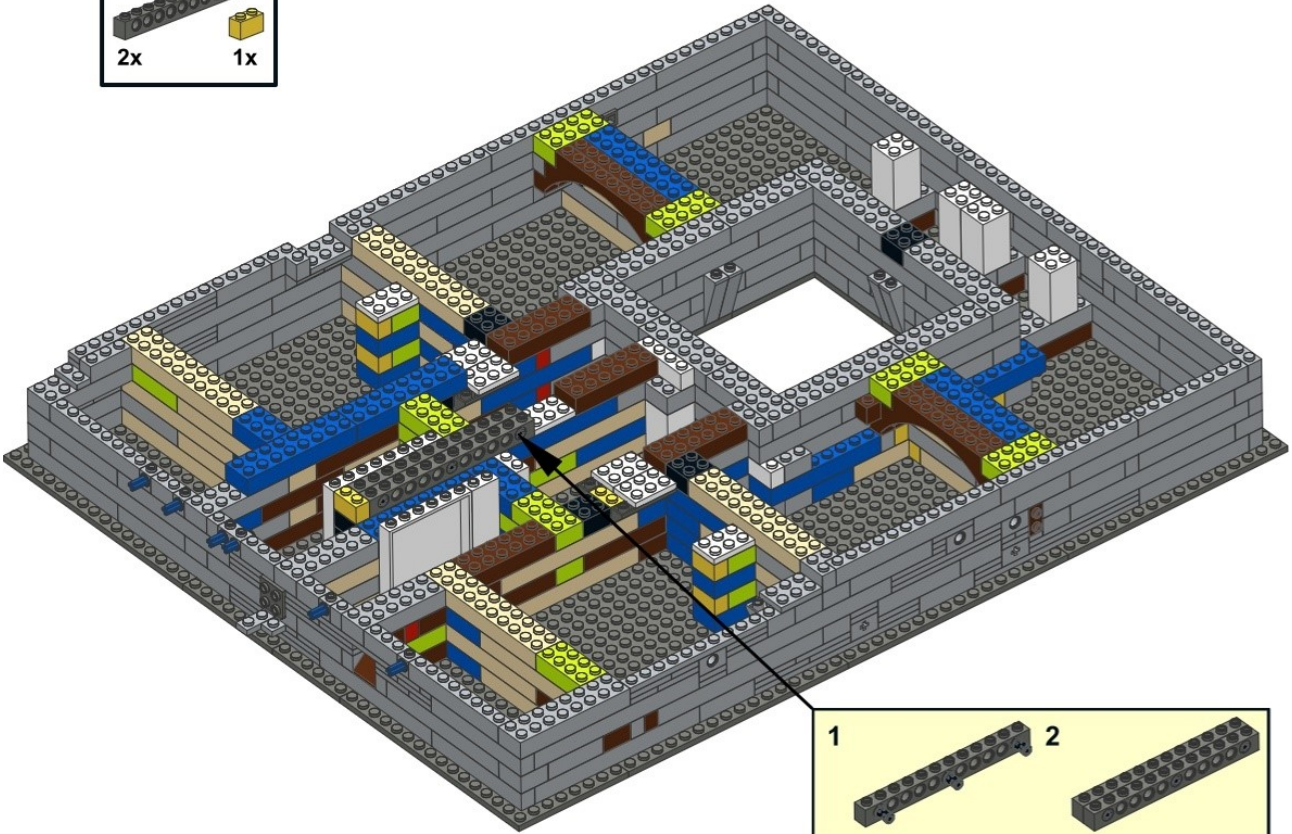
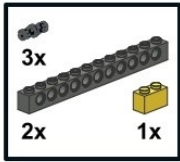

59

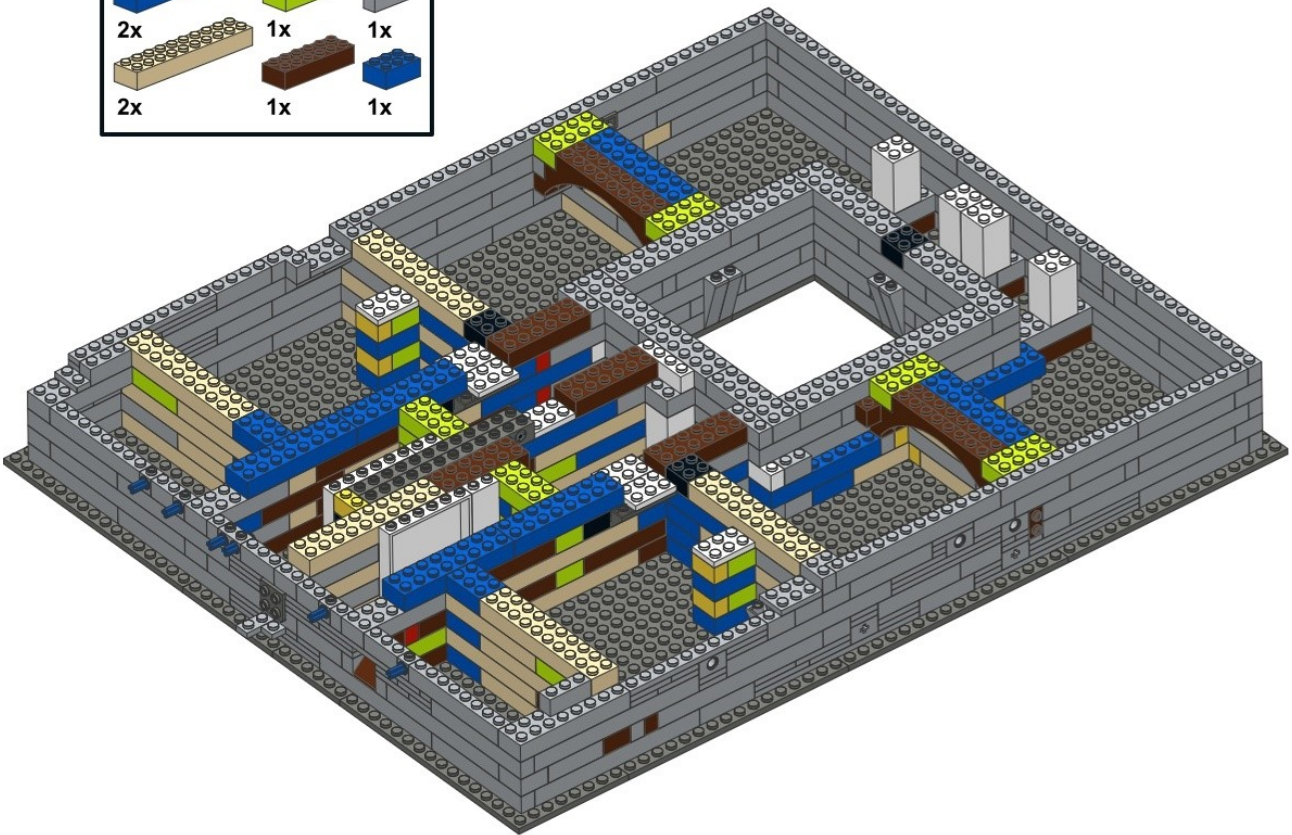
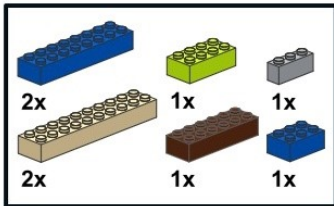



60

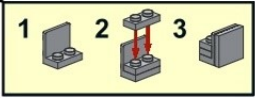
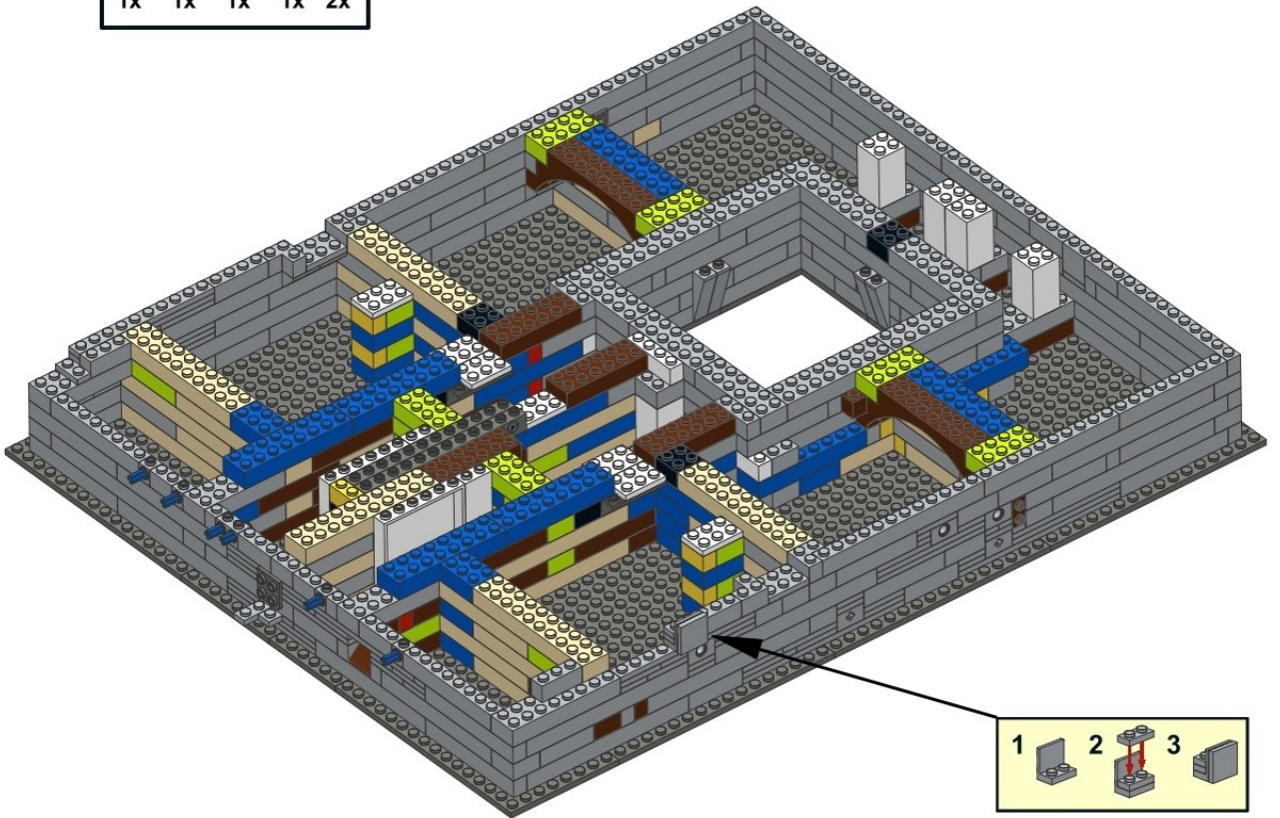
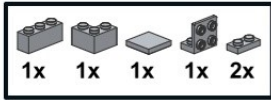

61

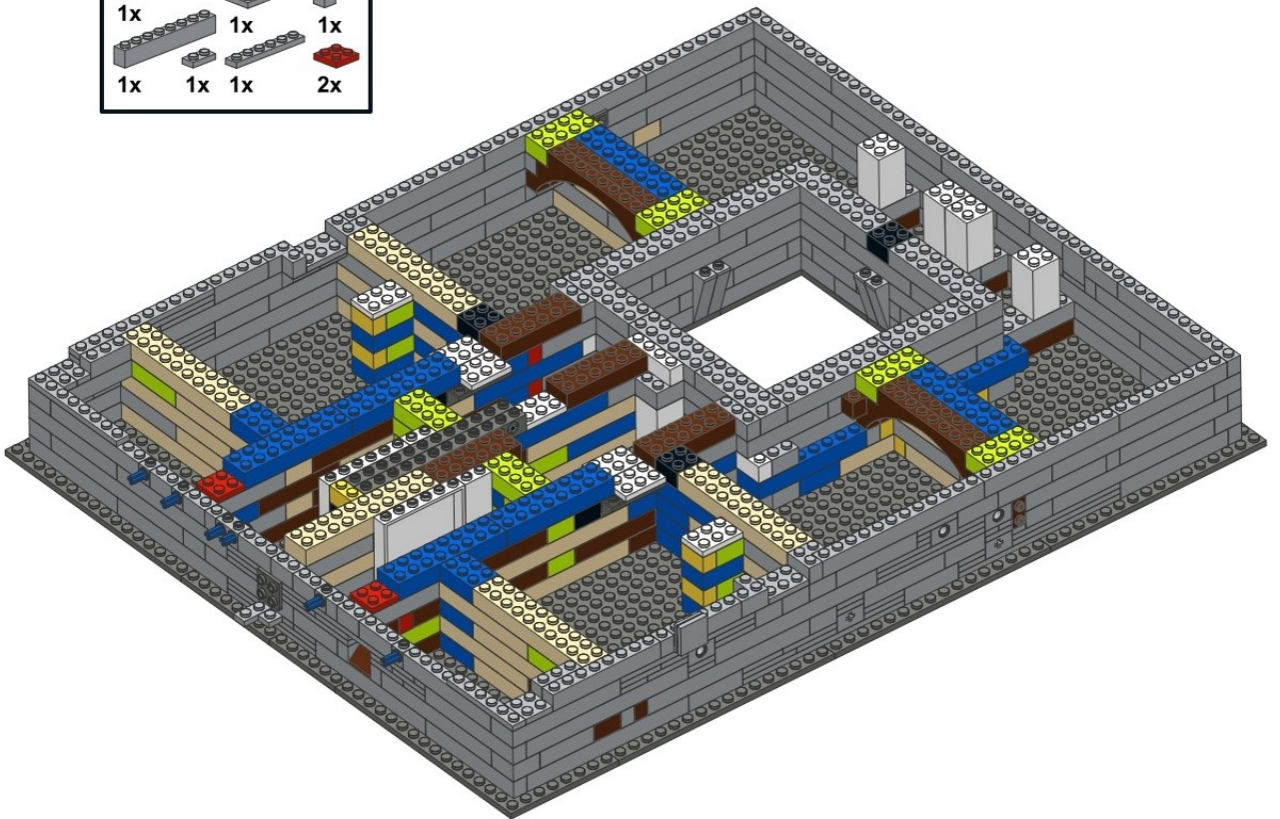
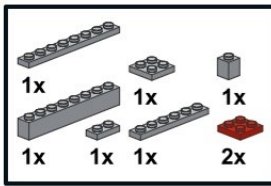



62

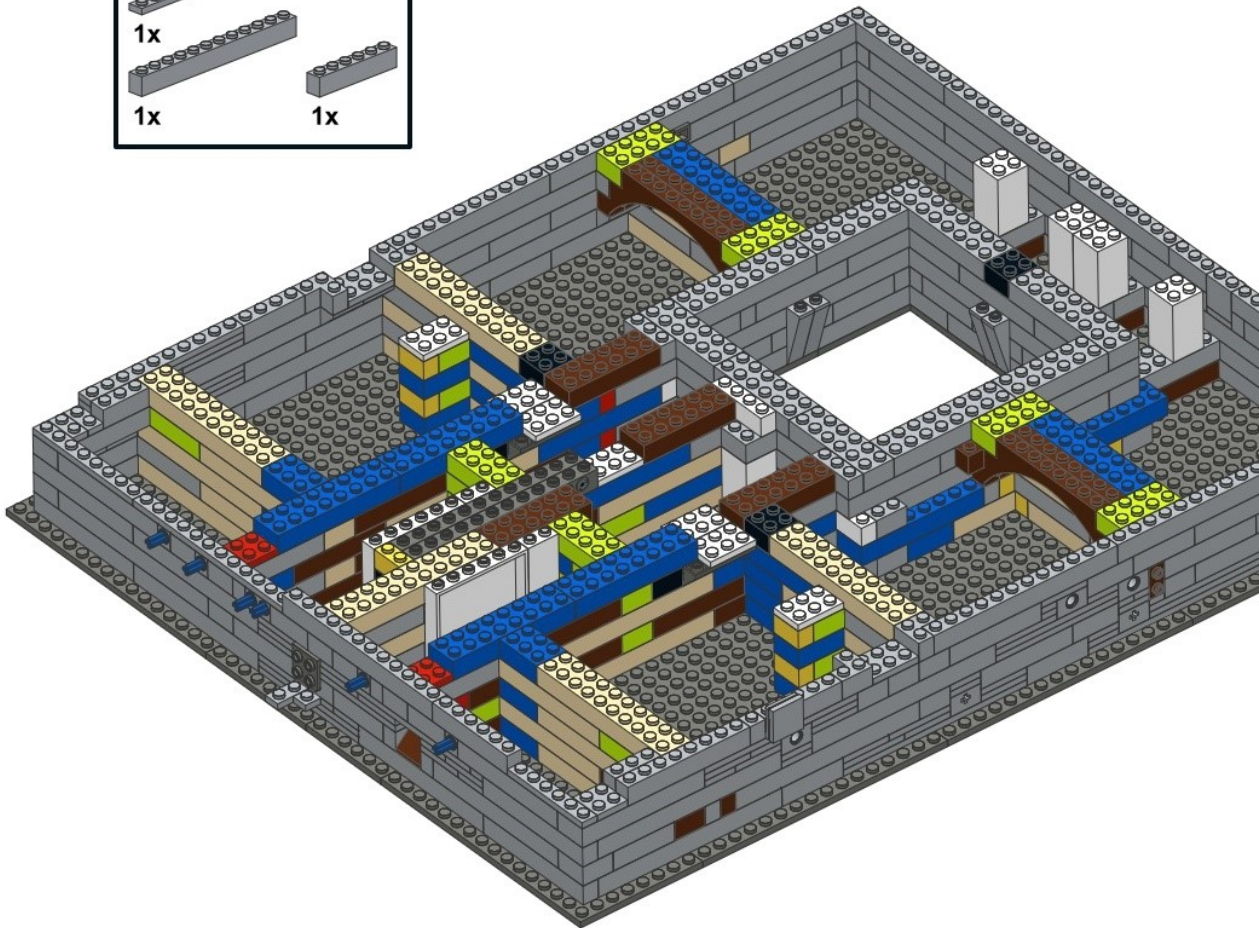
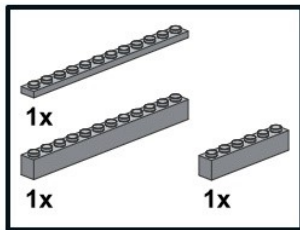

63

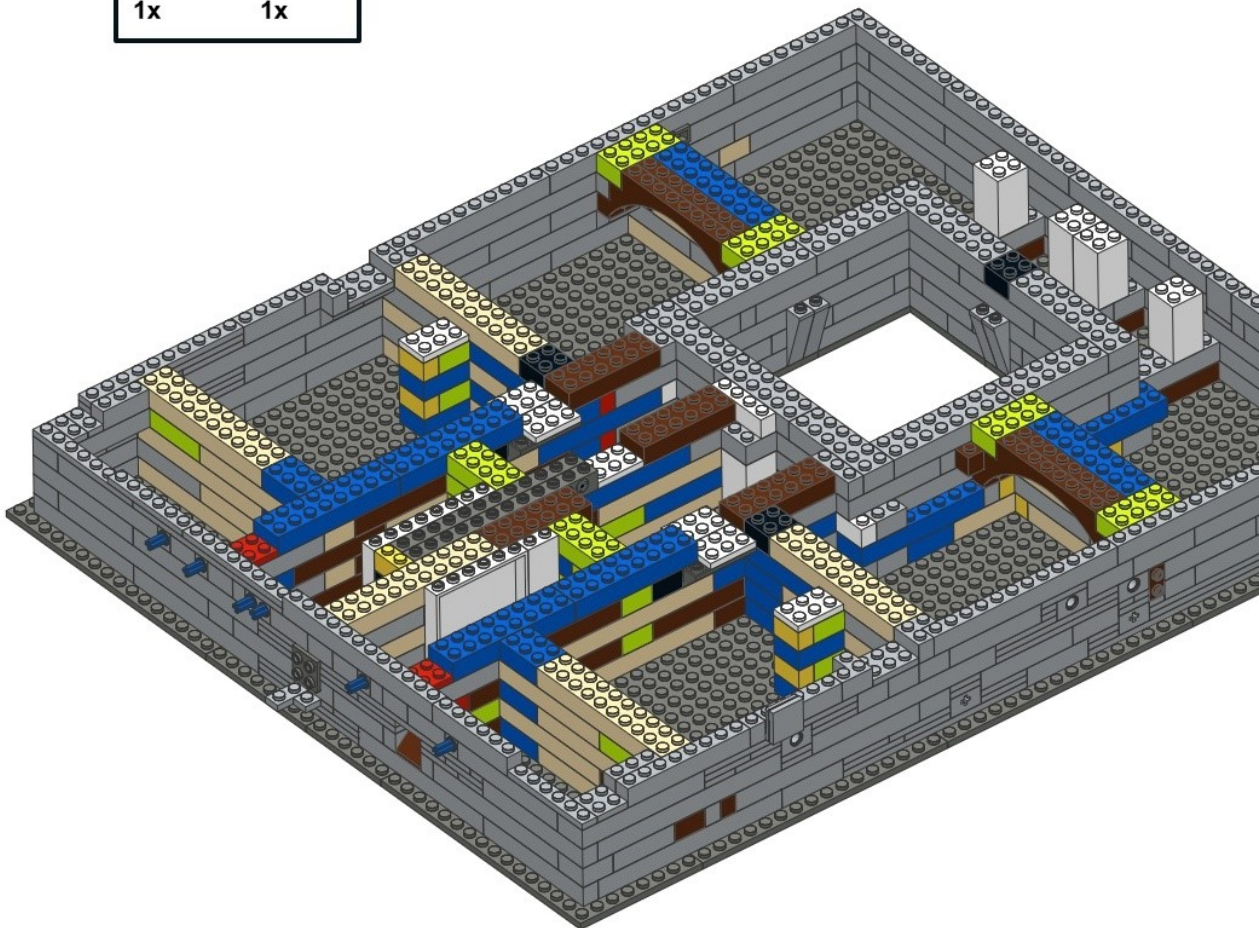
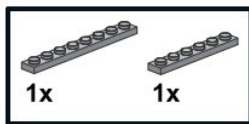



64

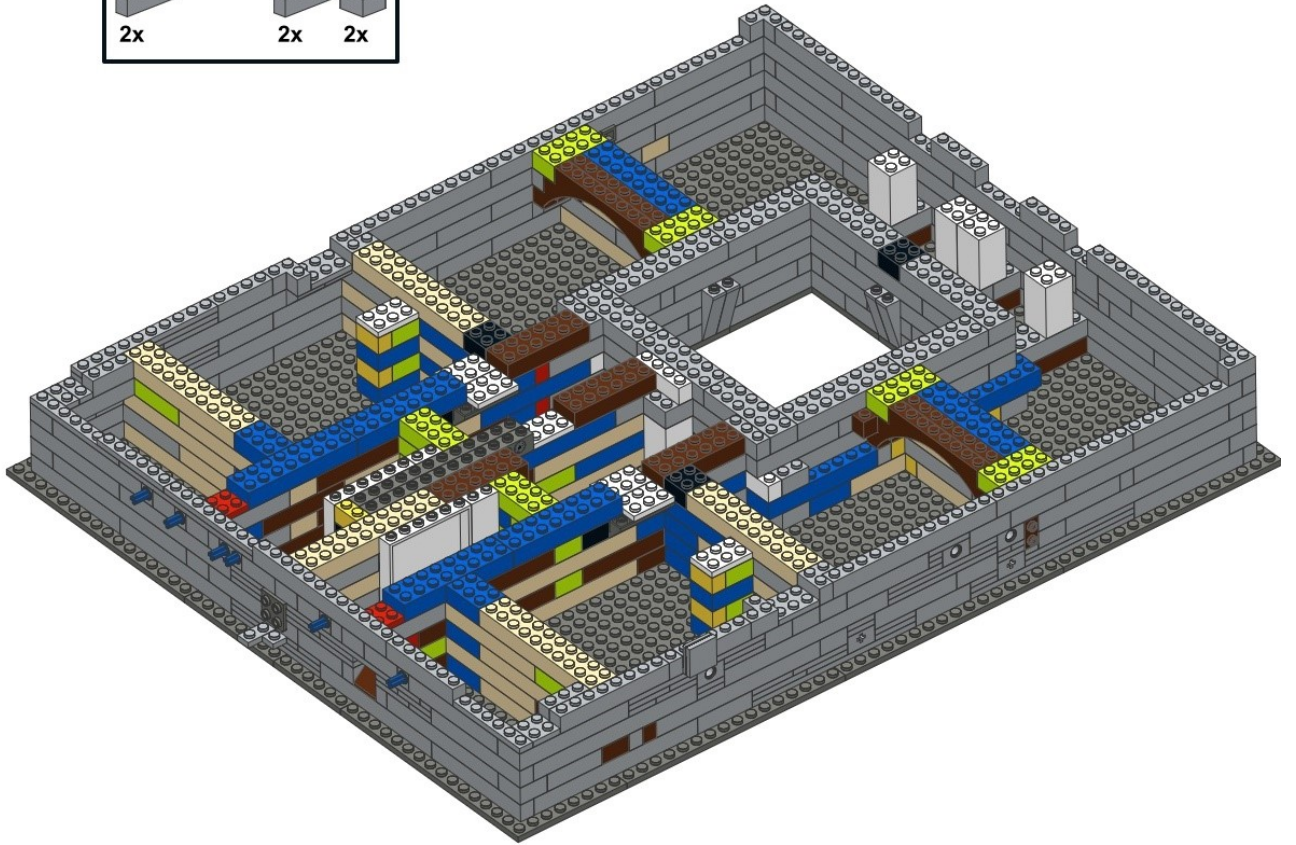
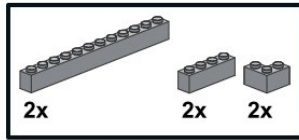

65

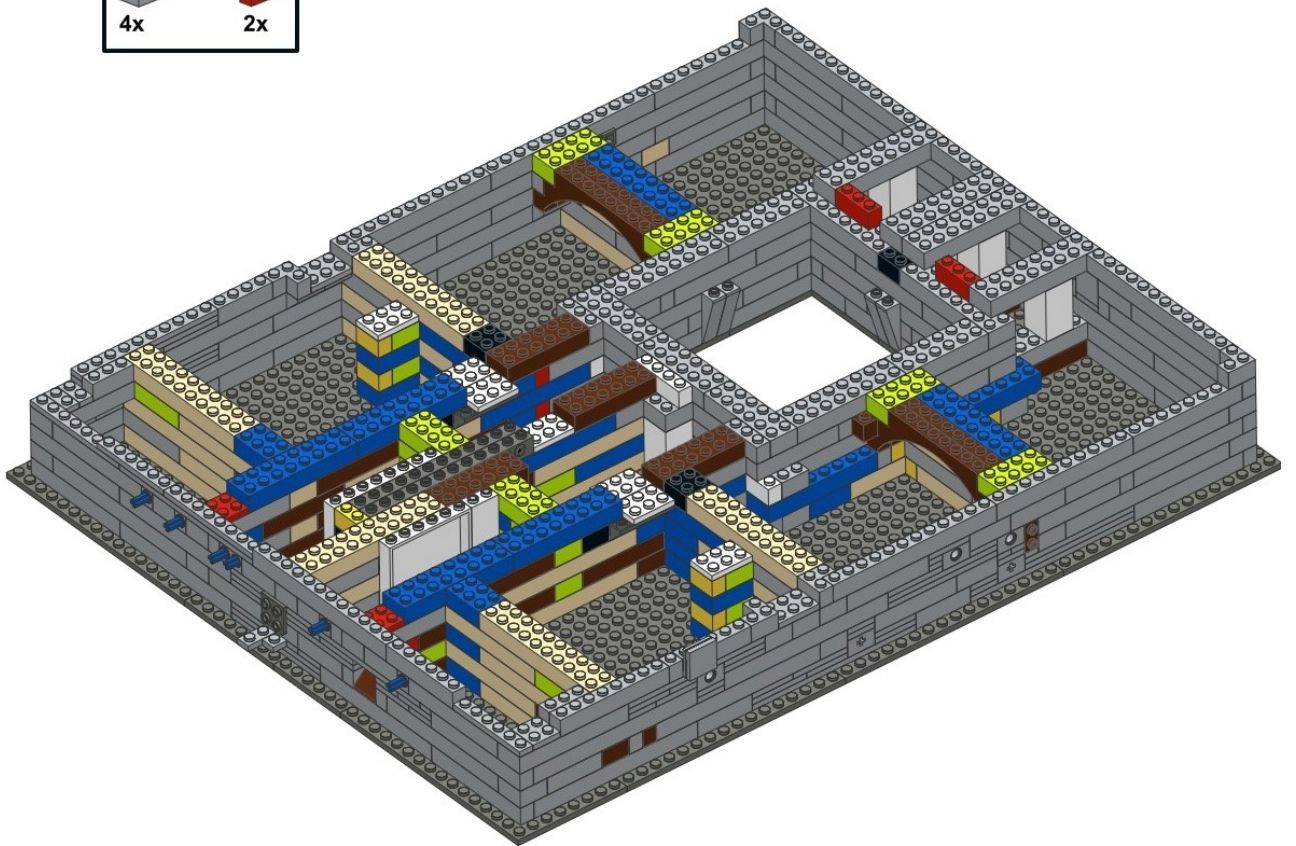
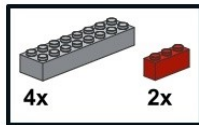



66

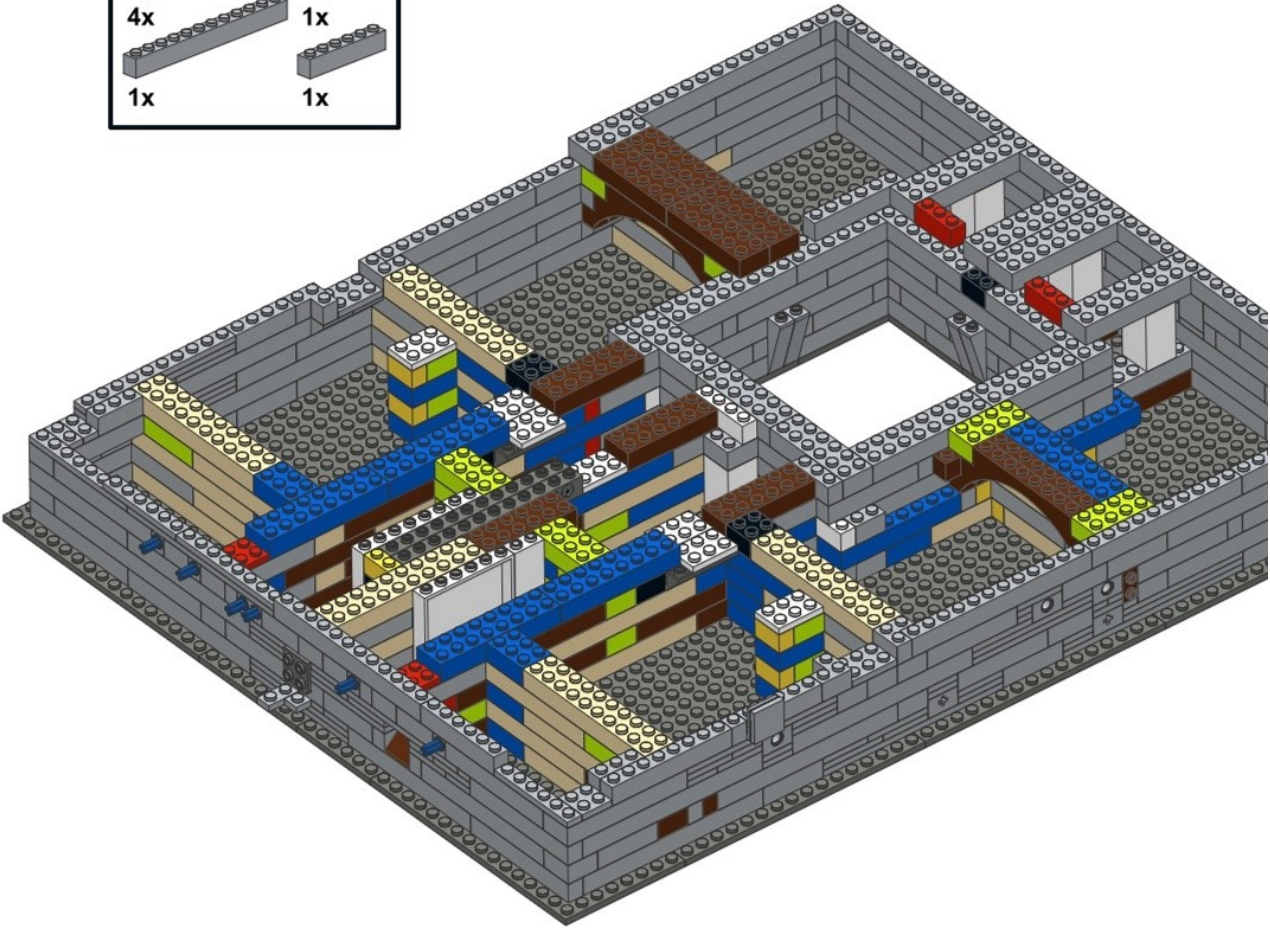
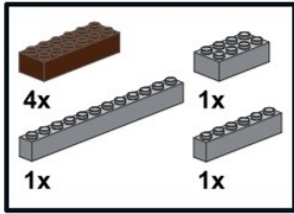

67

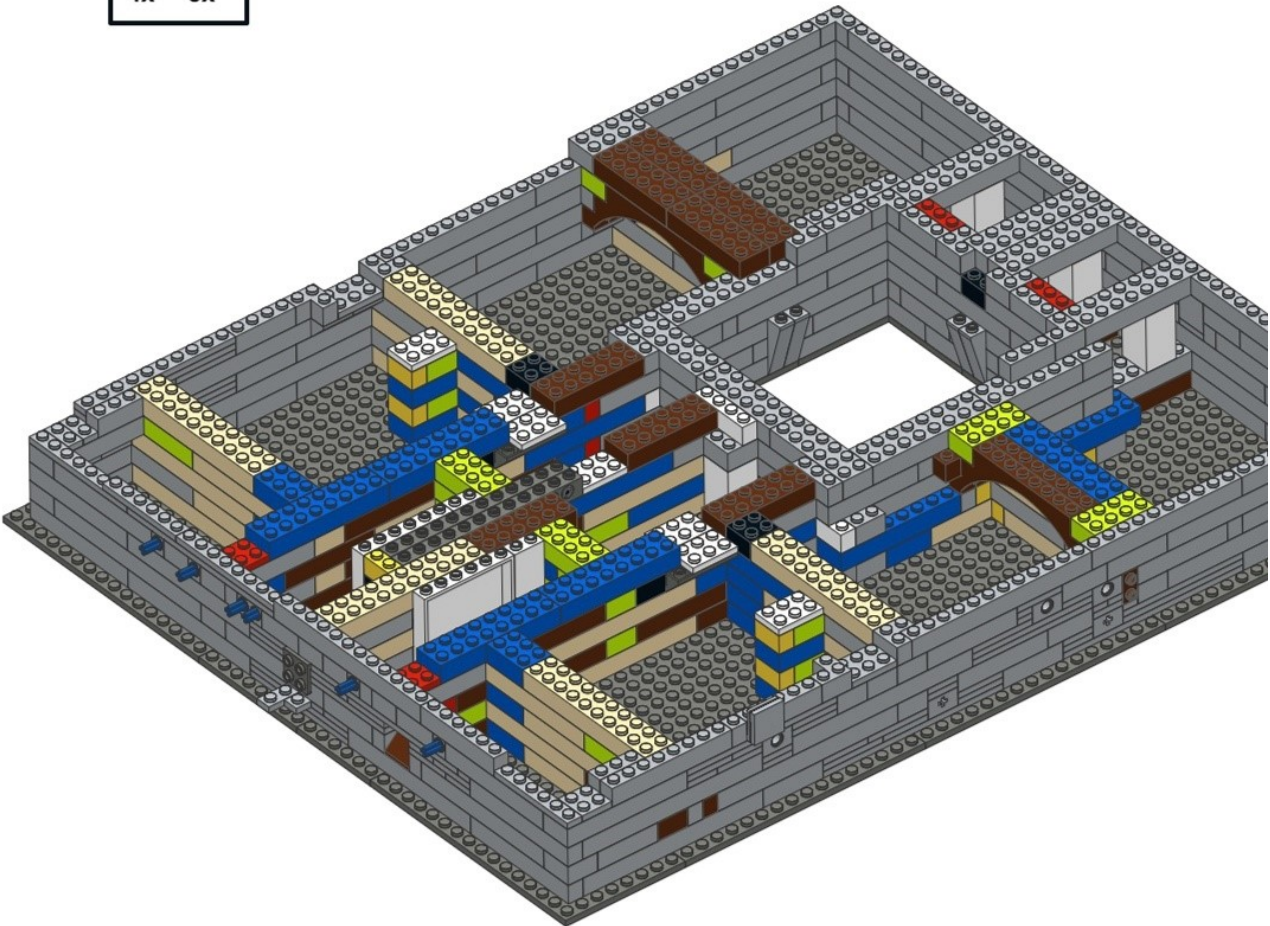
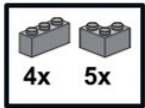



68

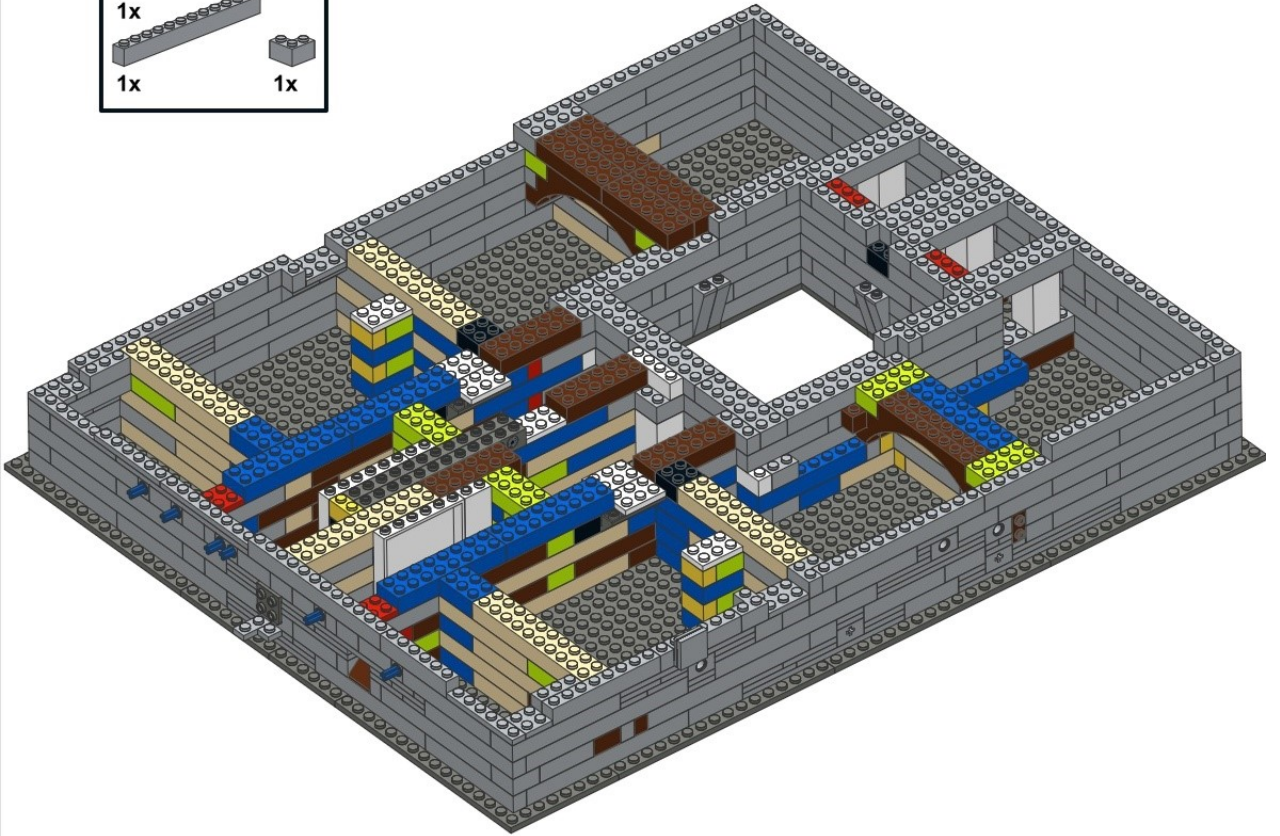
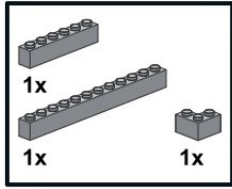

69

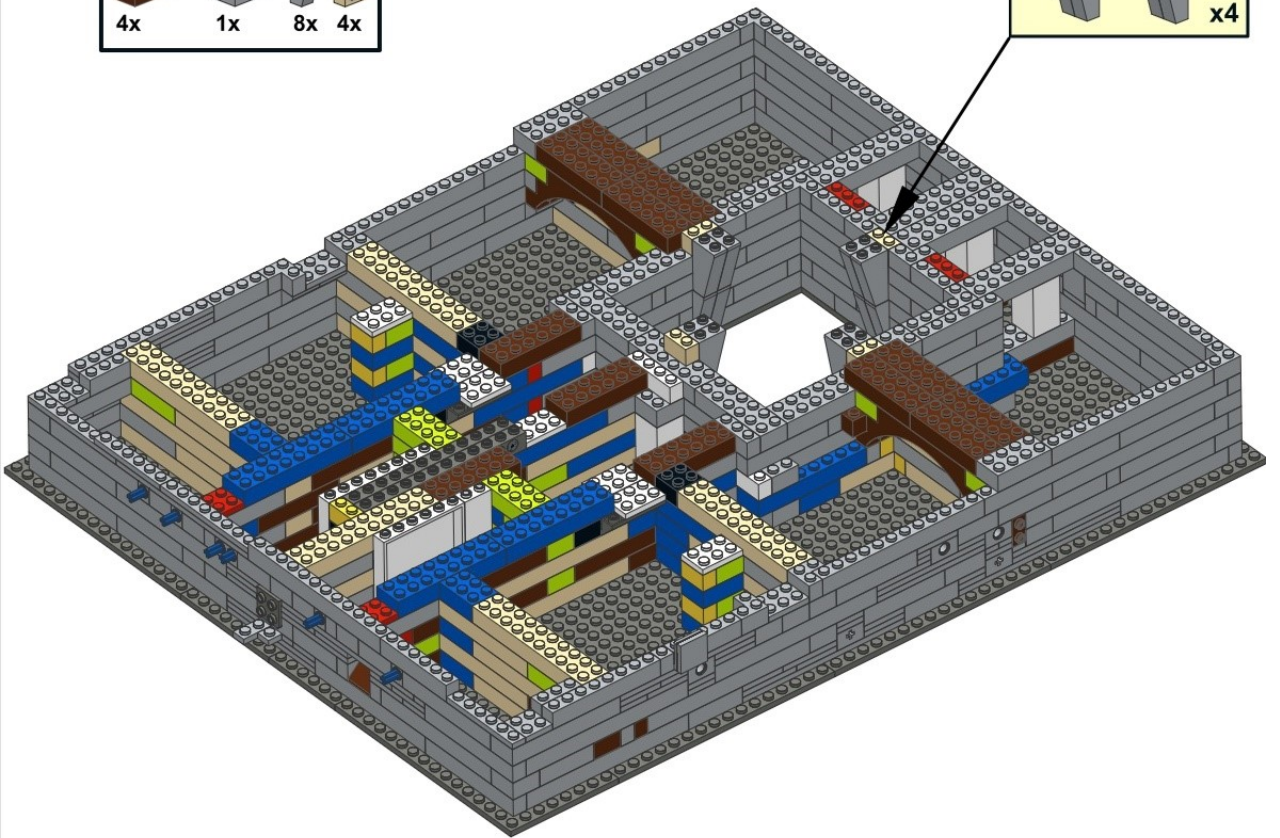
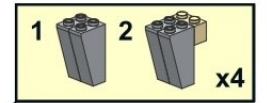
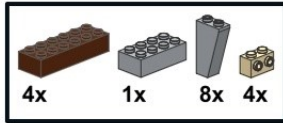



70

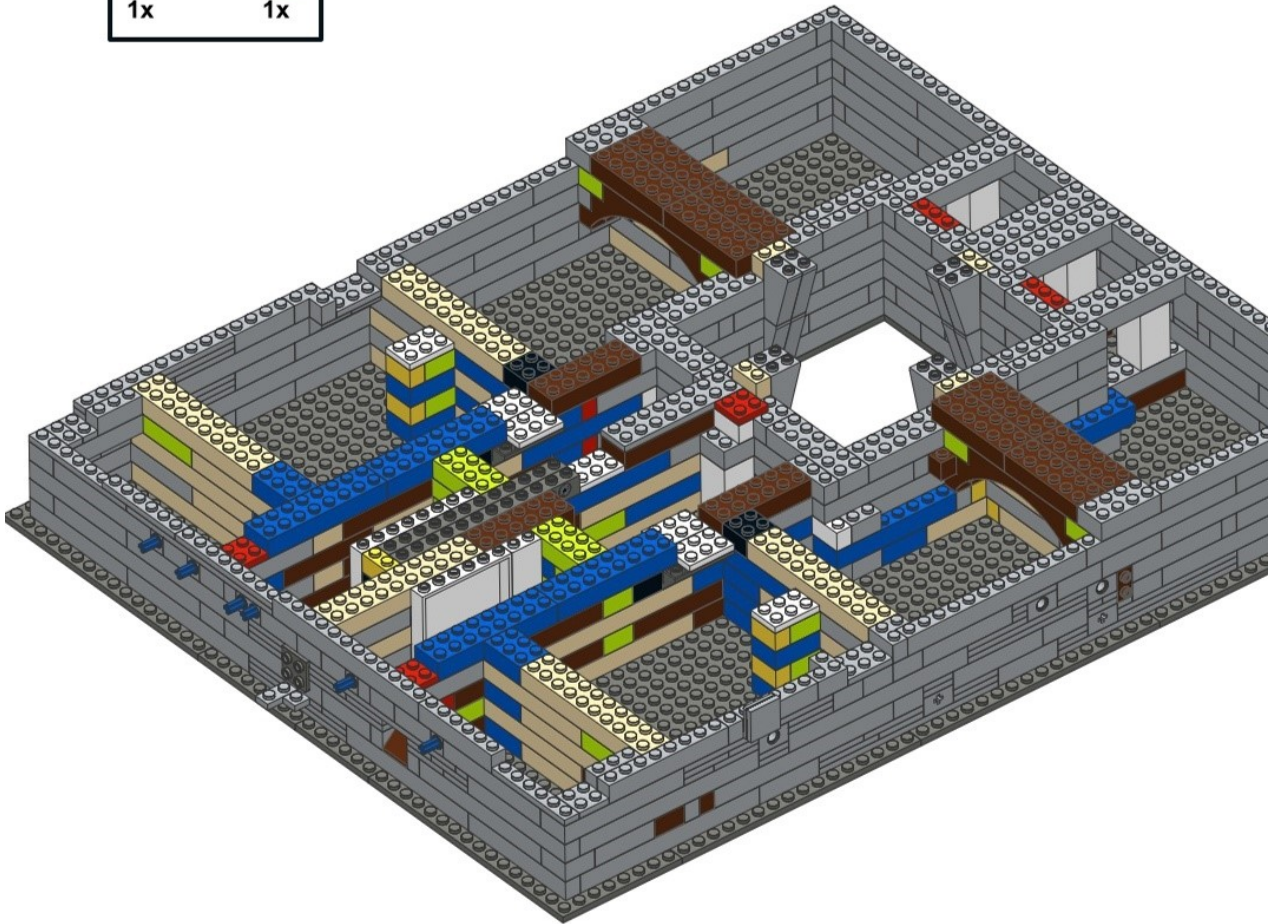
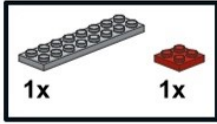

71

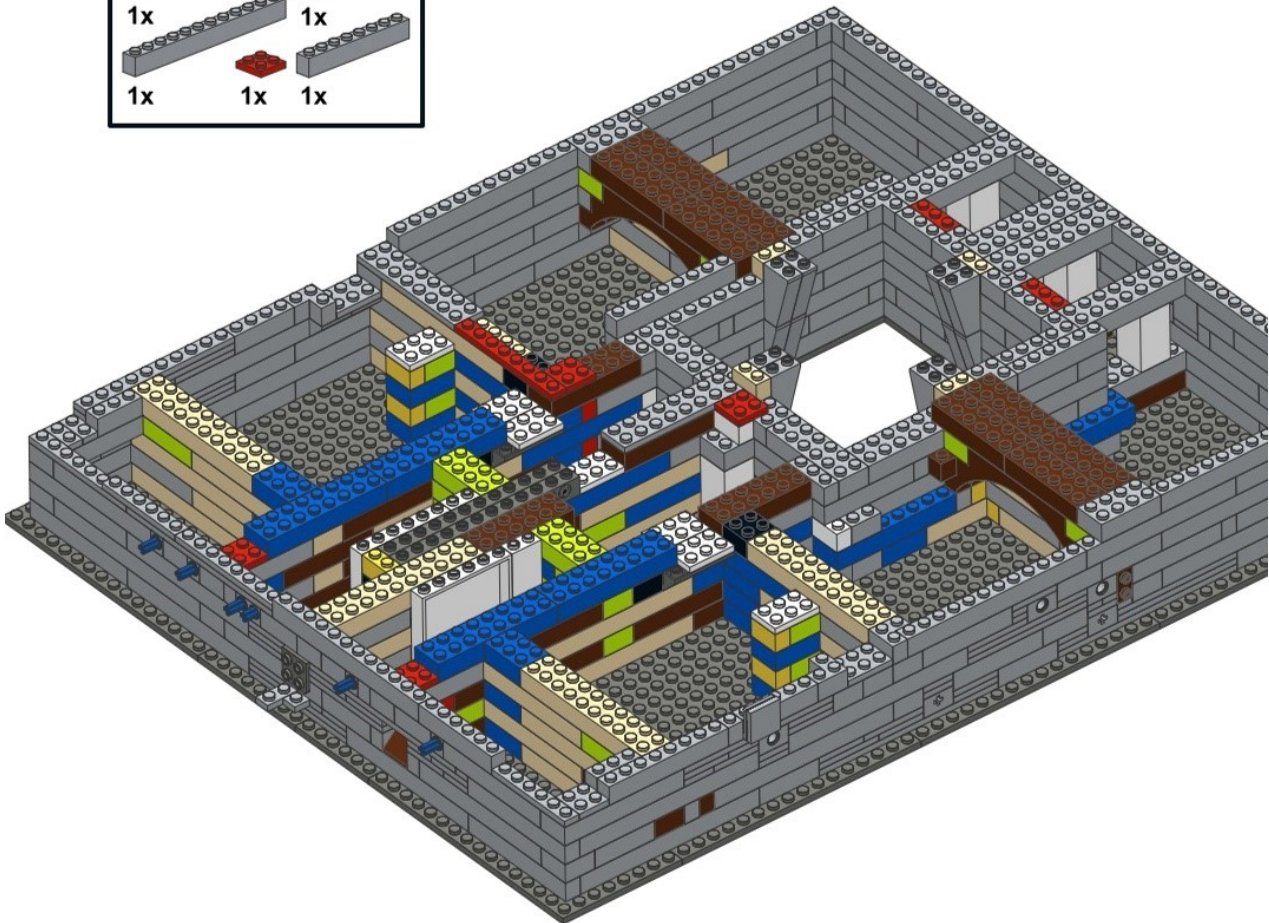
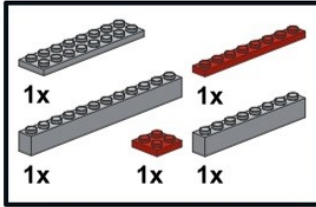



72

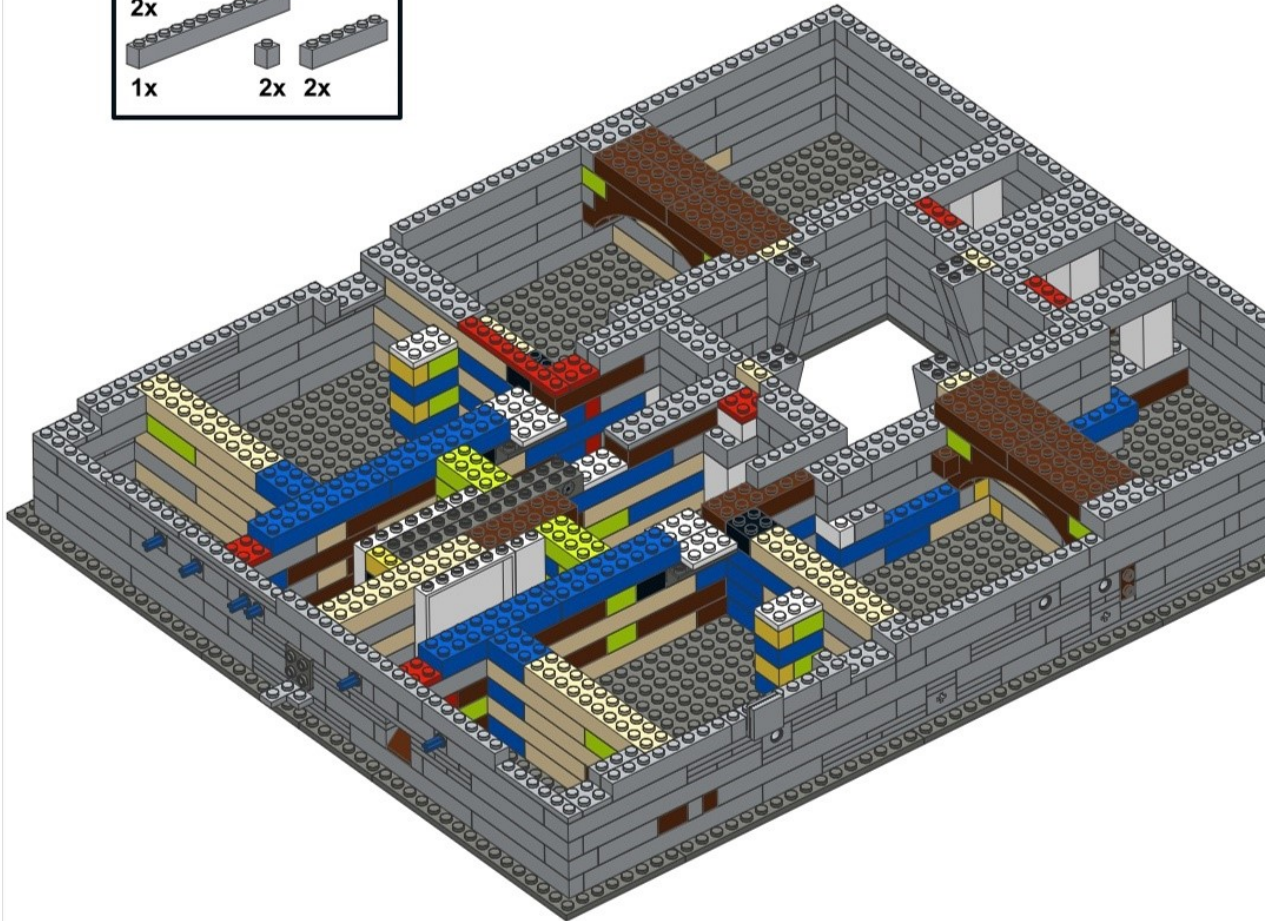
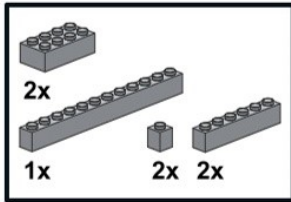

73

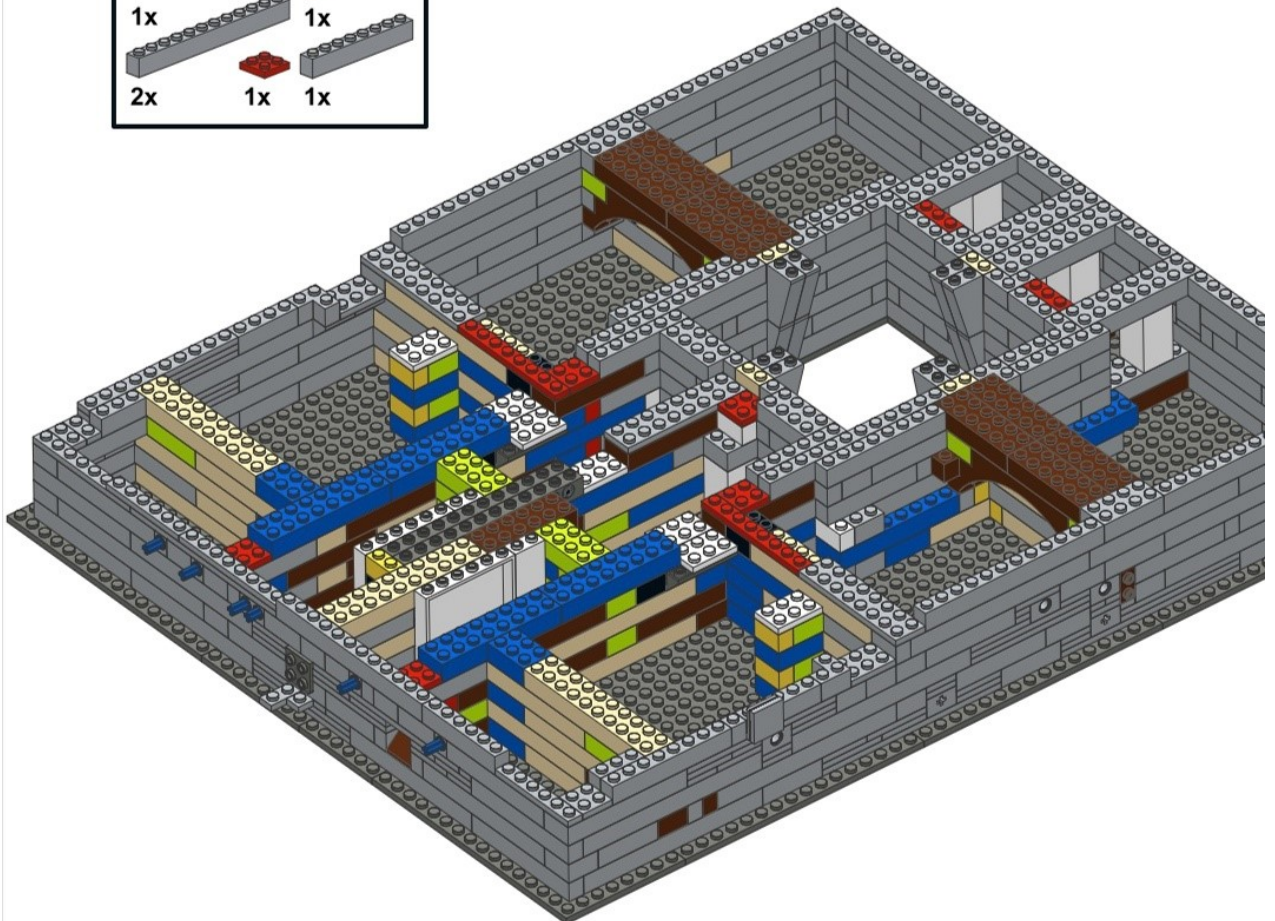
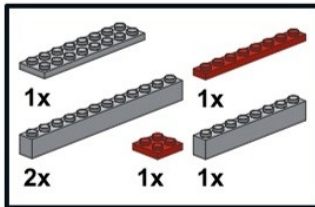



74

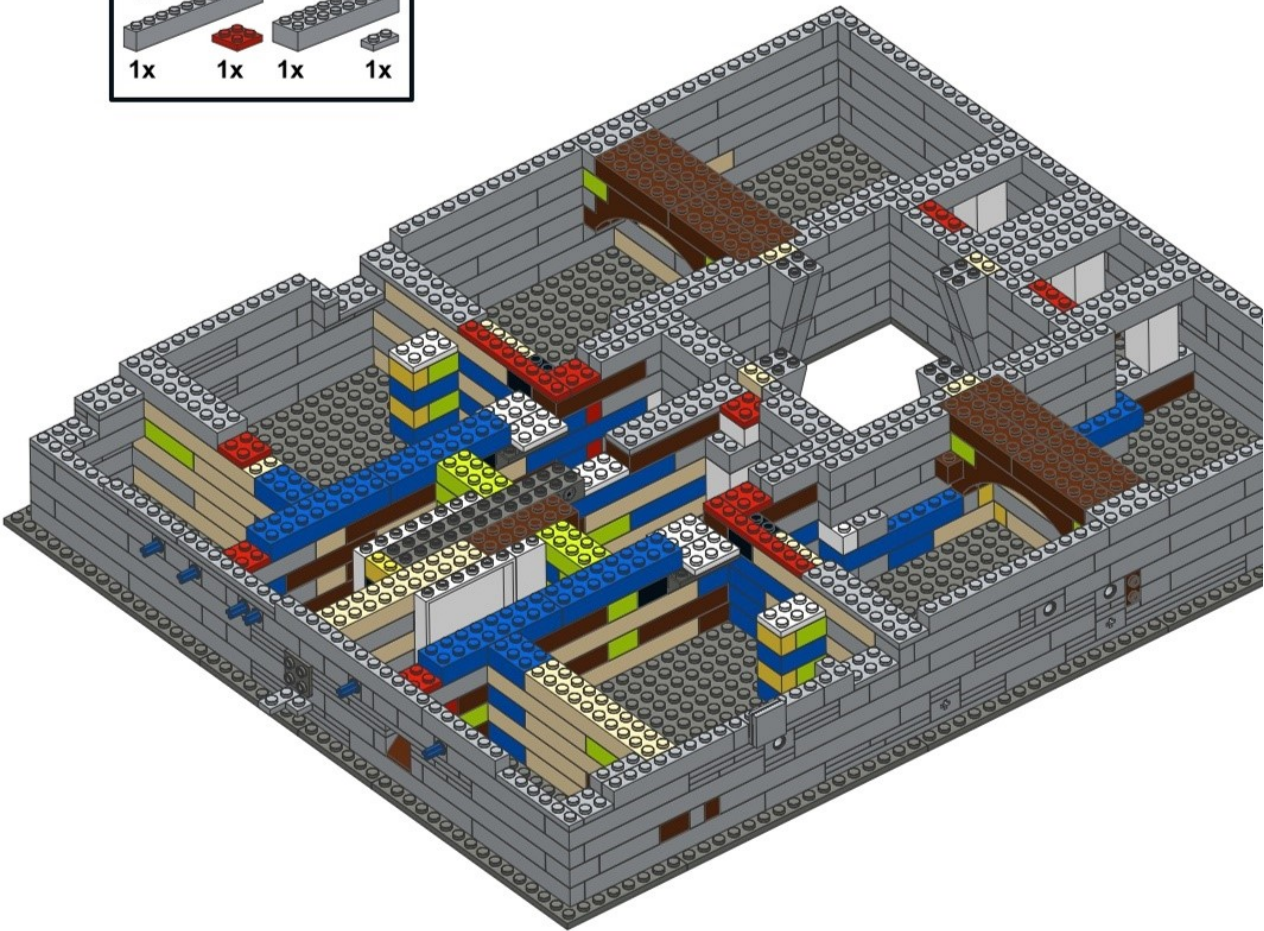
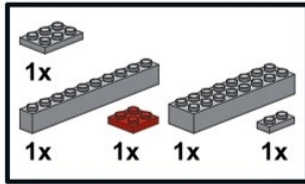

75

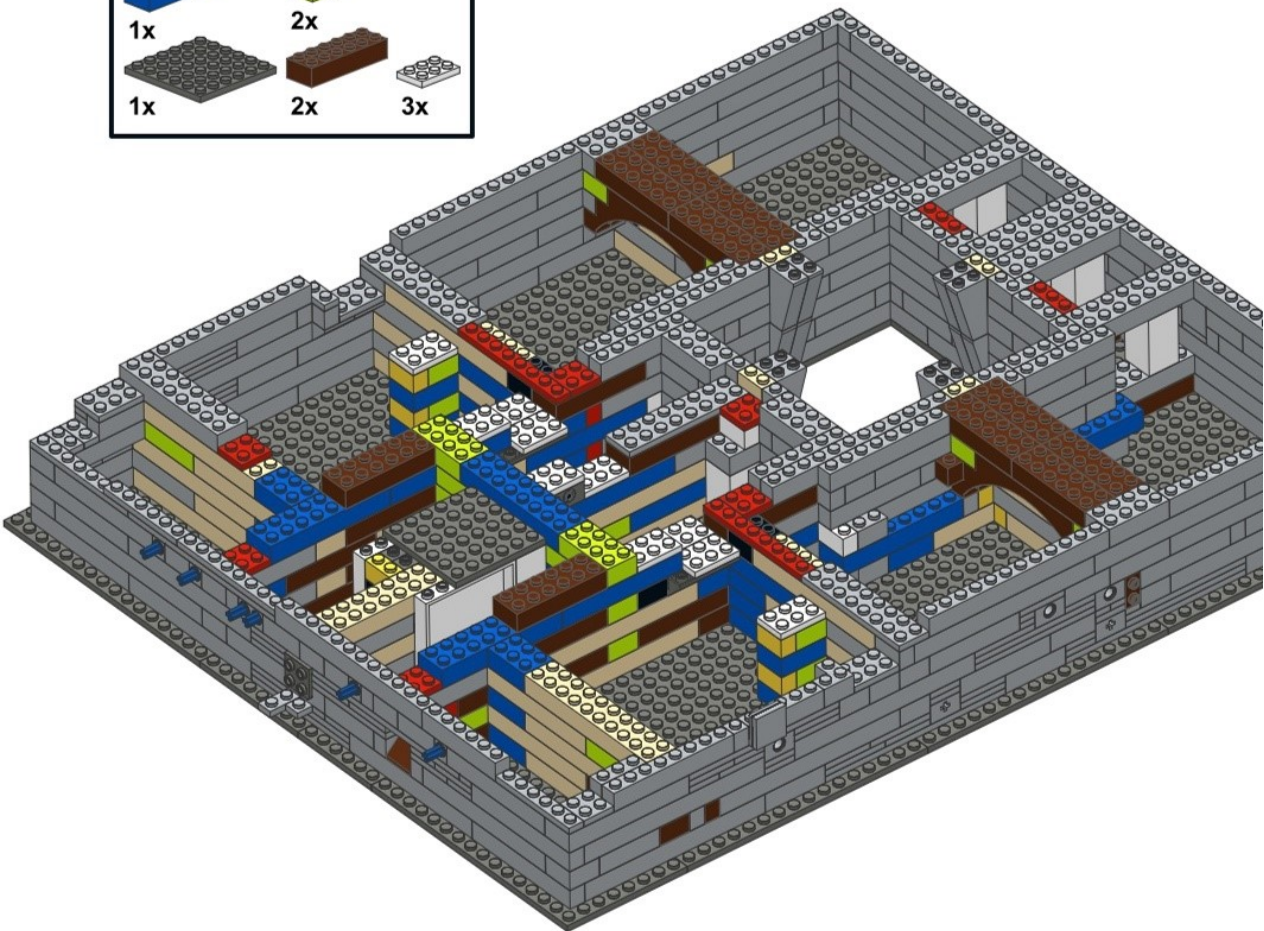
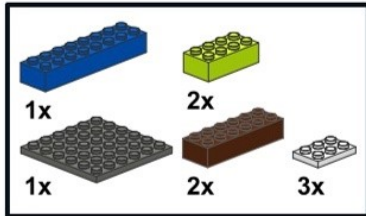



76

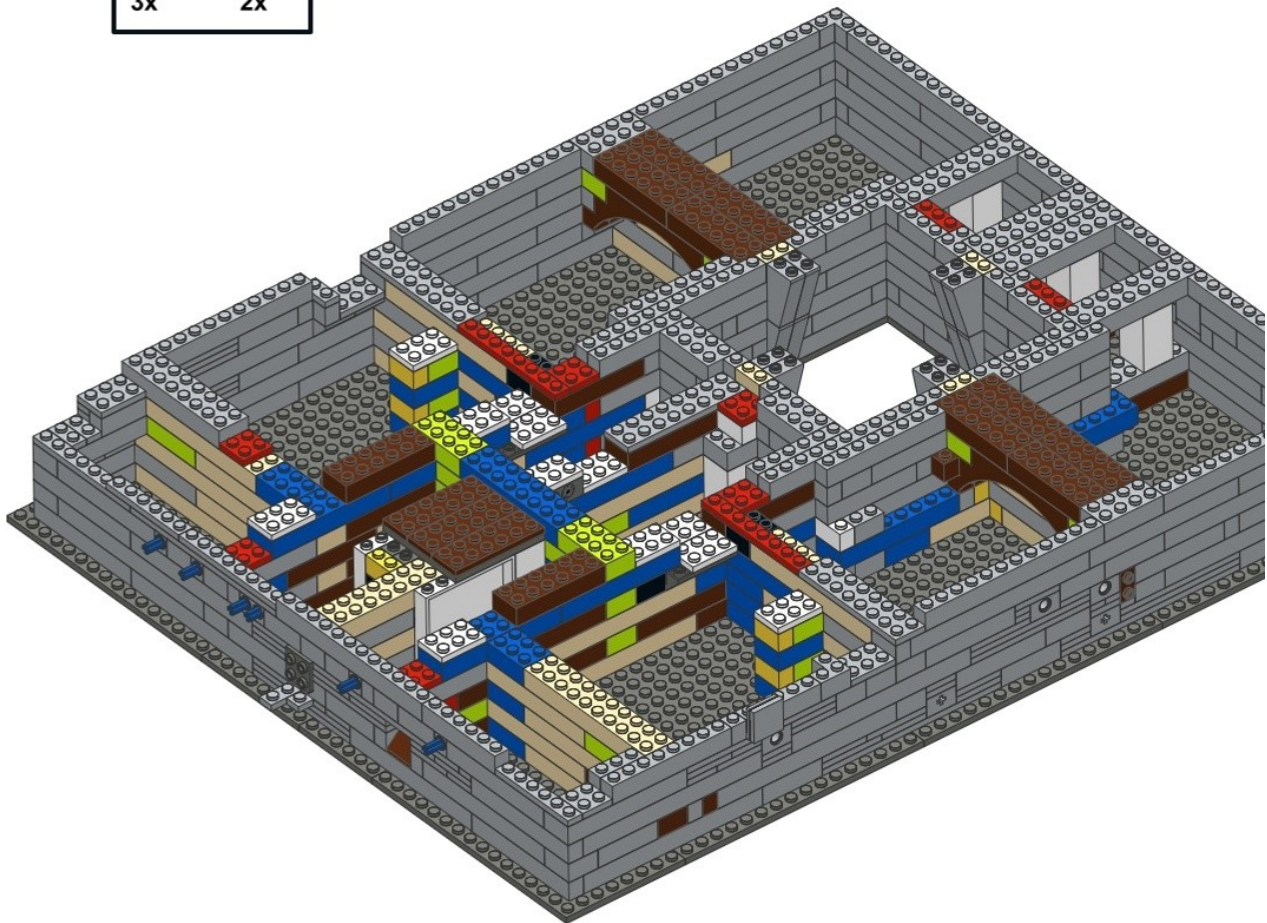
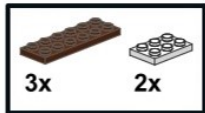

77

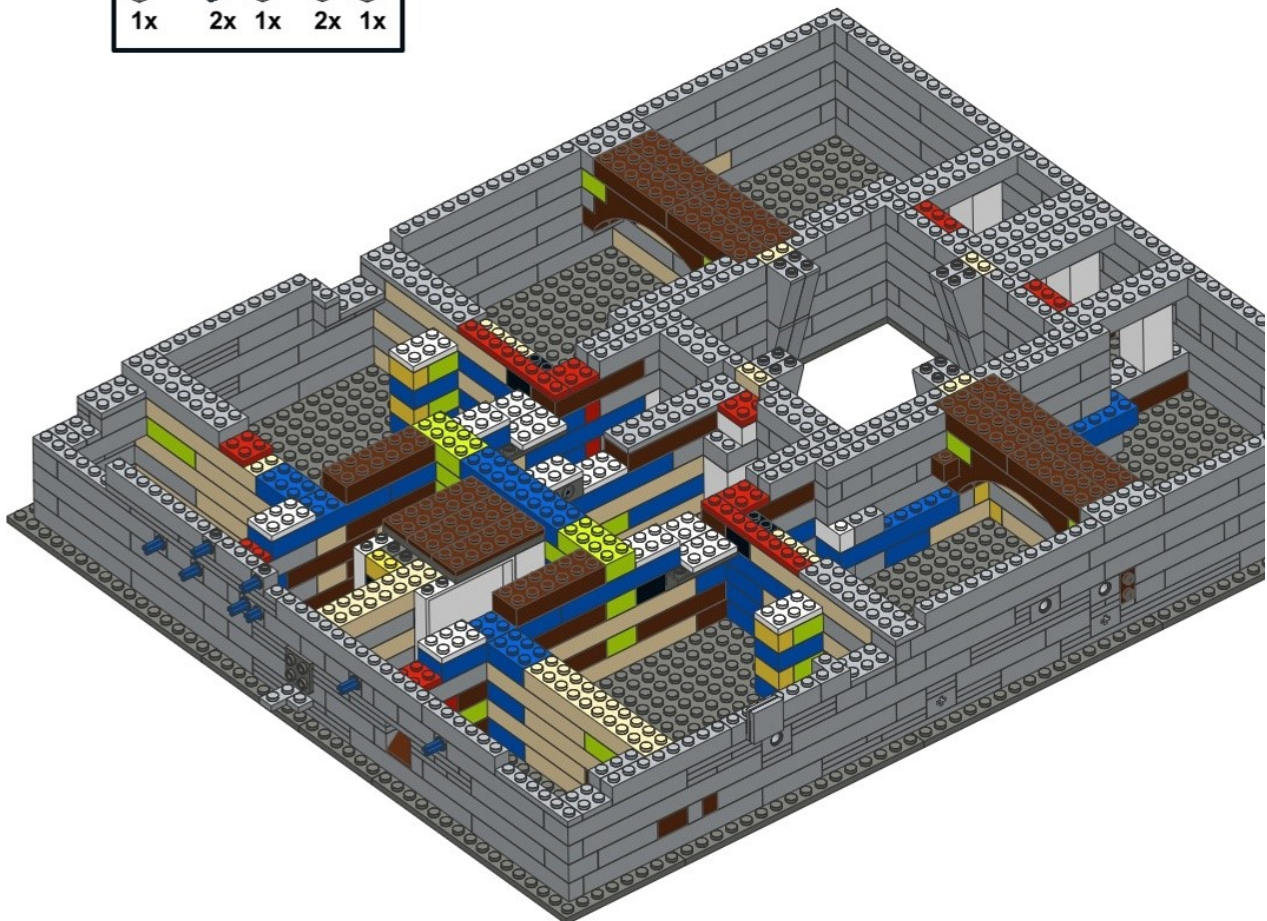
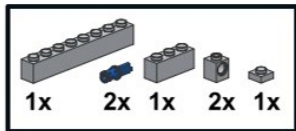



78

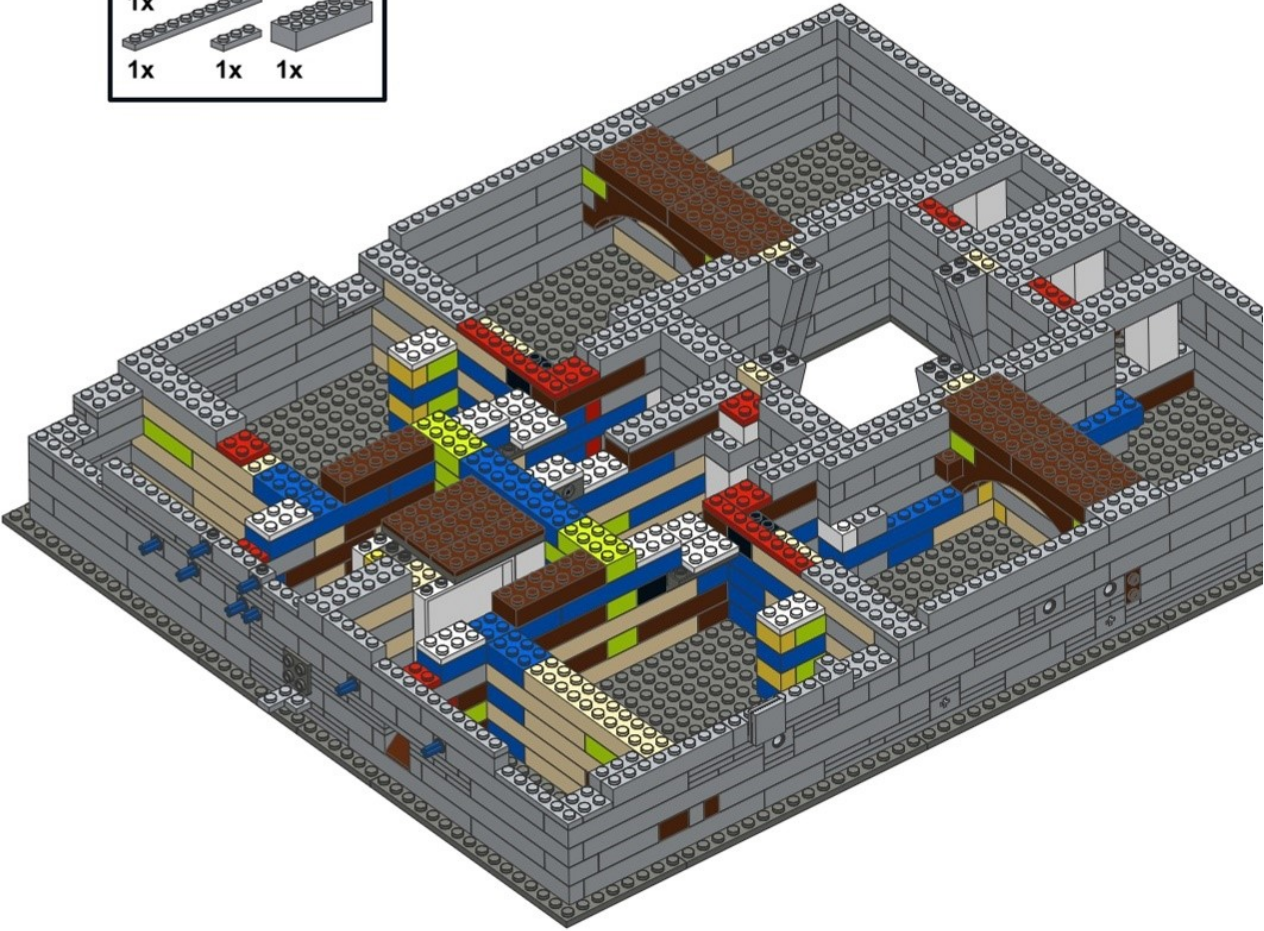
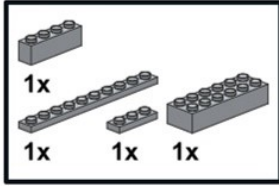

79

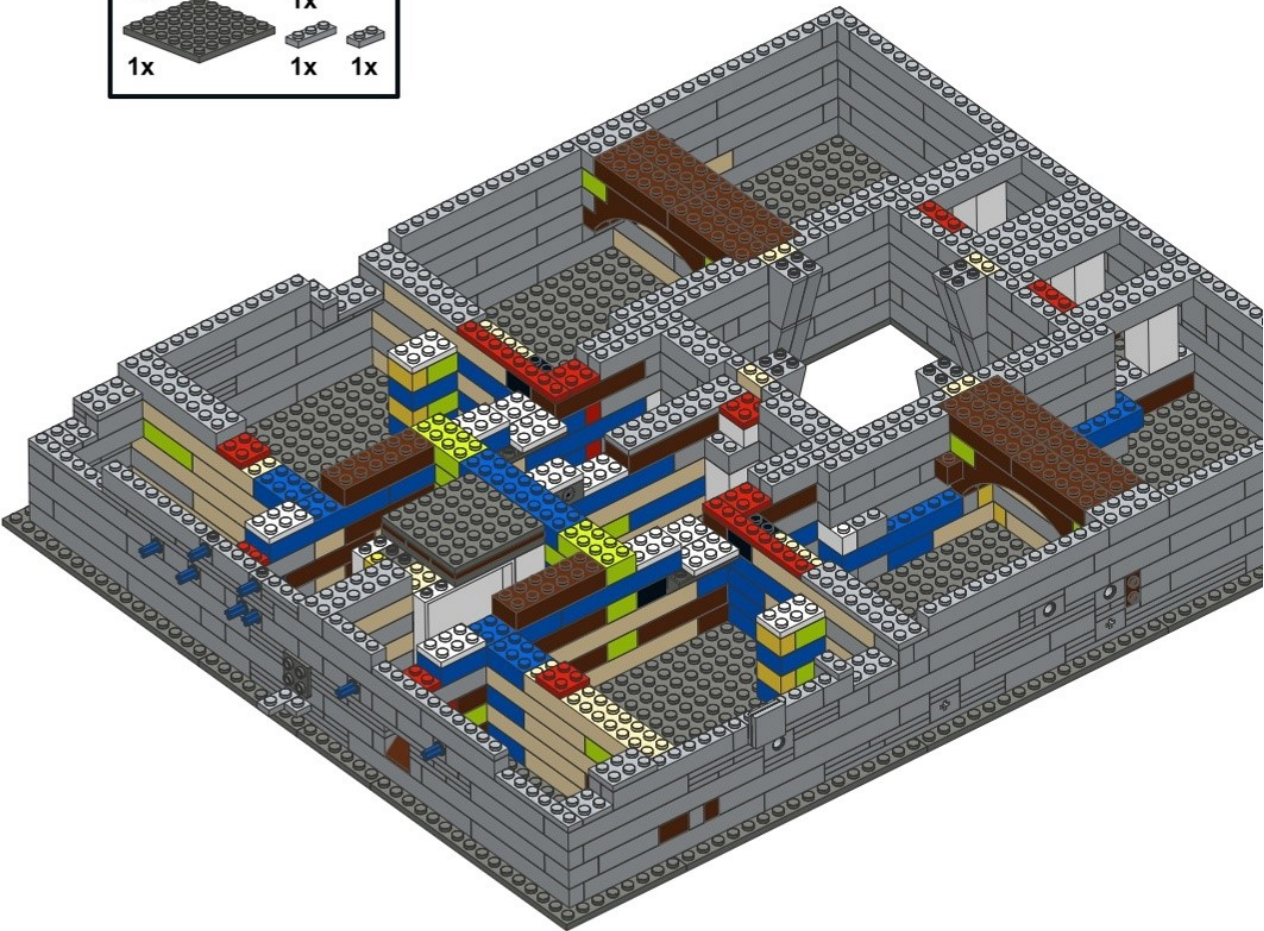
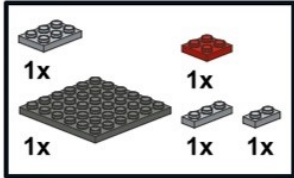



80

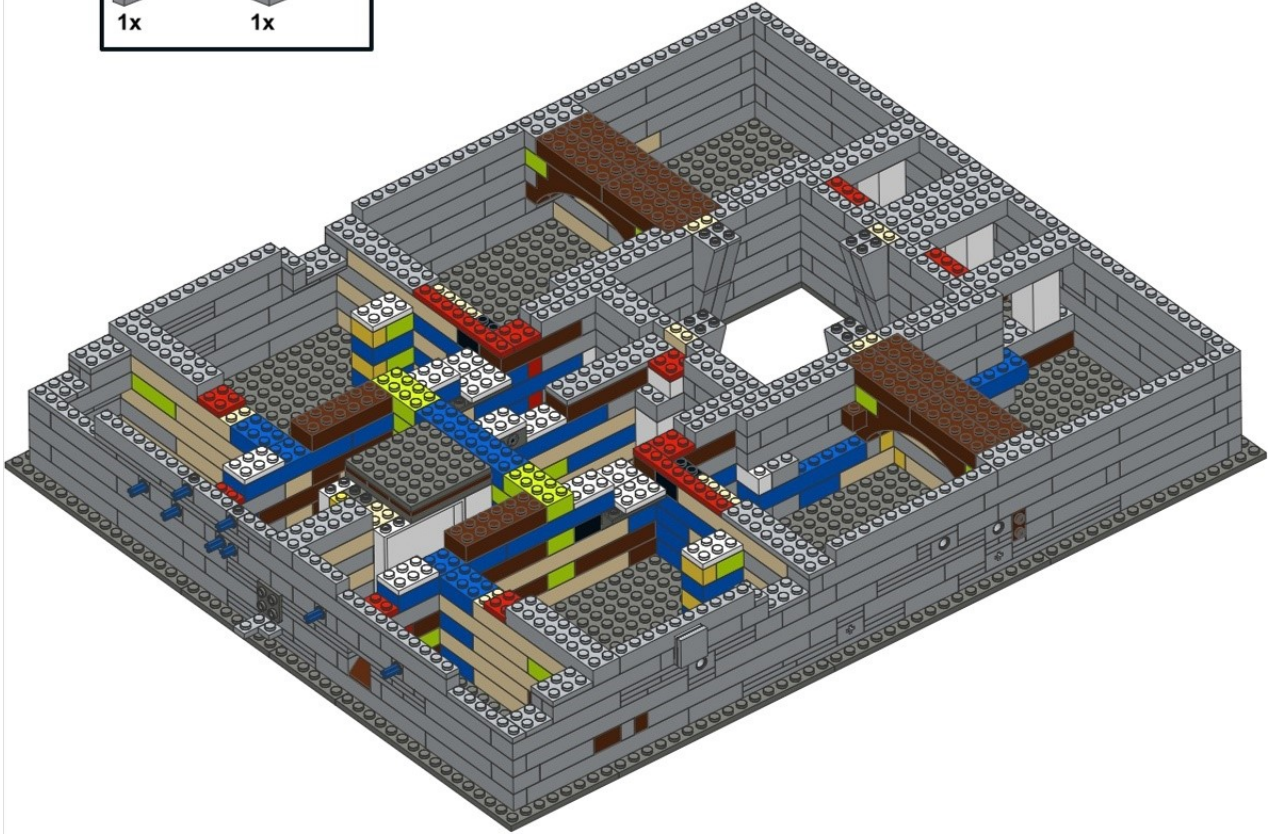
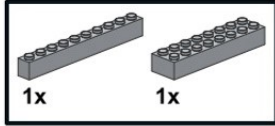

81

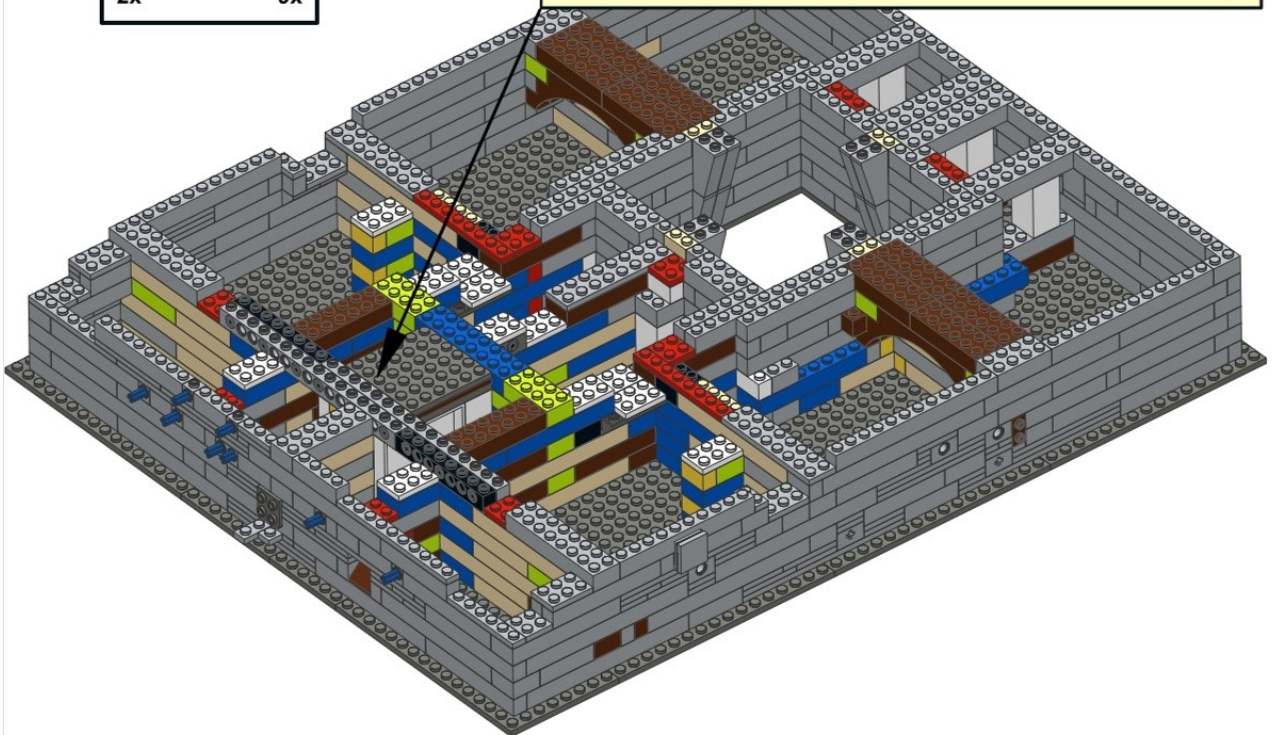
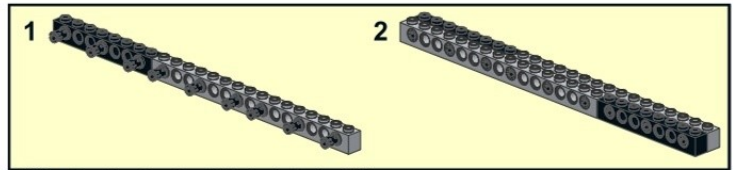
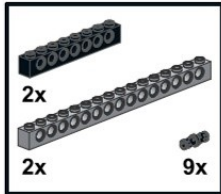



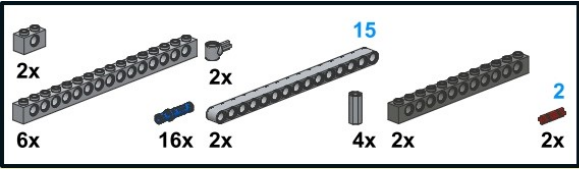

1

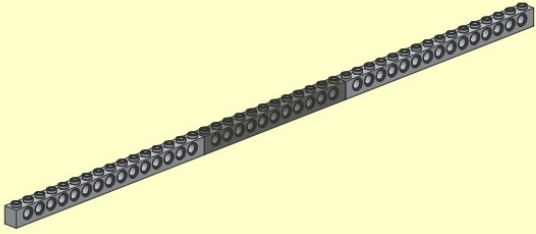

2

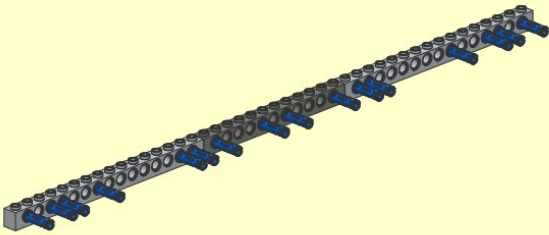

3

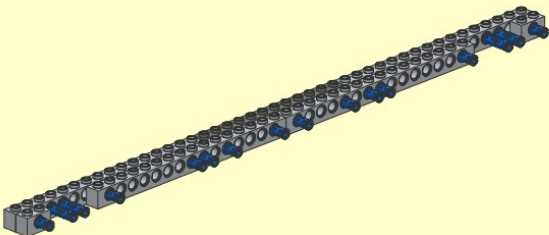

4

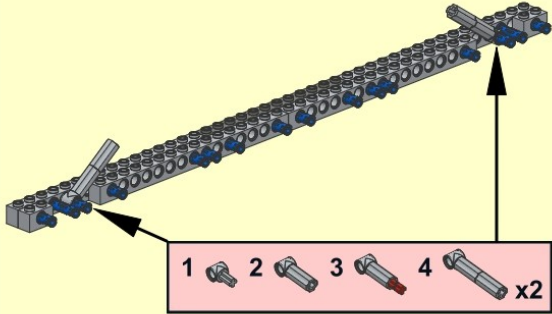

5

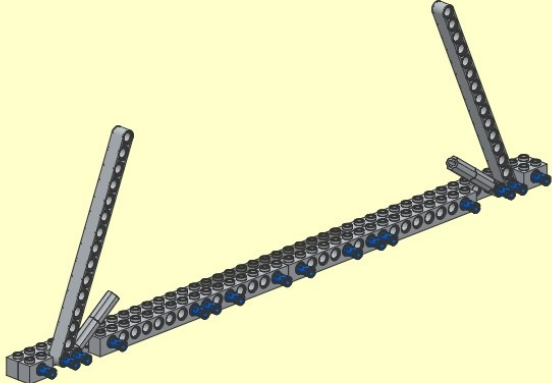

6

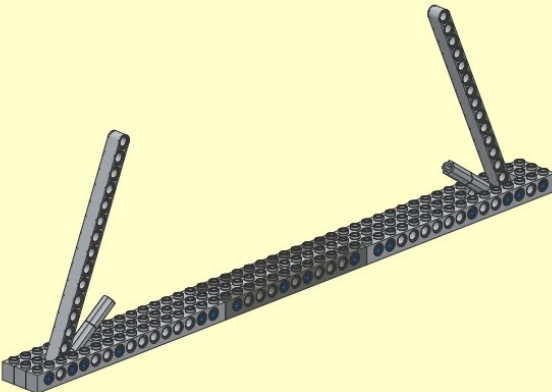

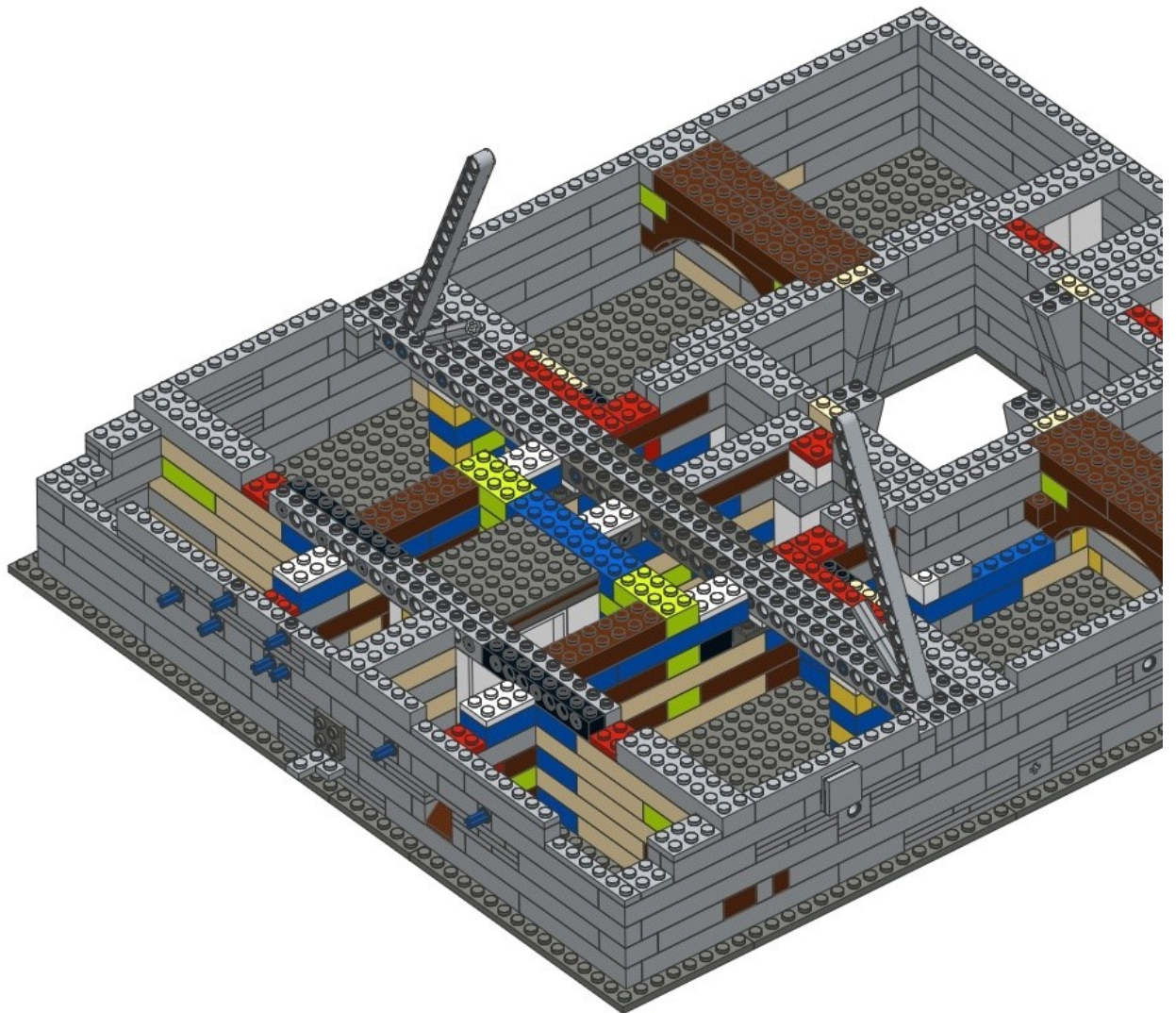



83

3x	15	1x
1x		2
1x		1x
1x	1x	2x
		2x

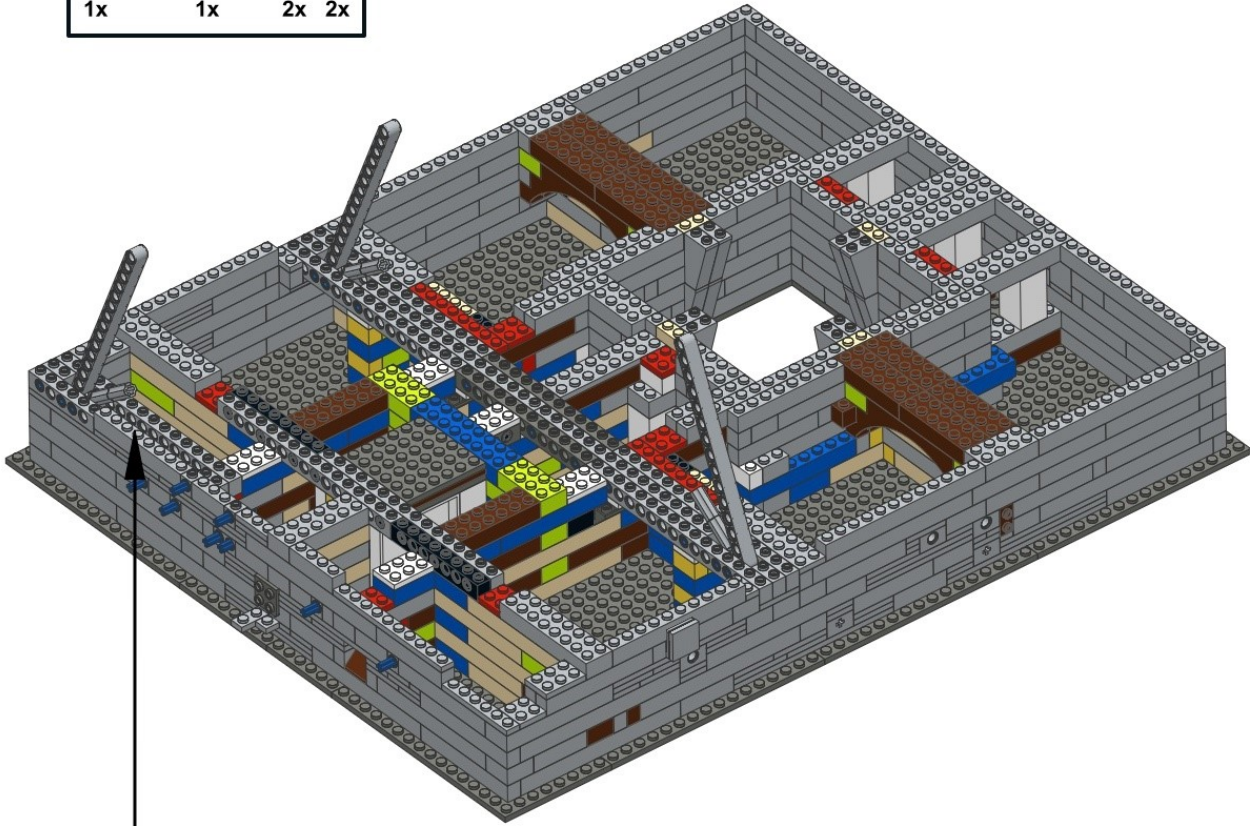

1	2	3	1	
			2	
			3	
			4	

4	5

# 84



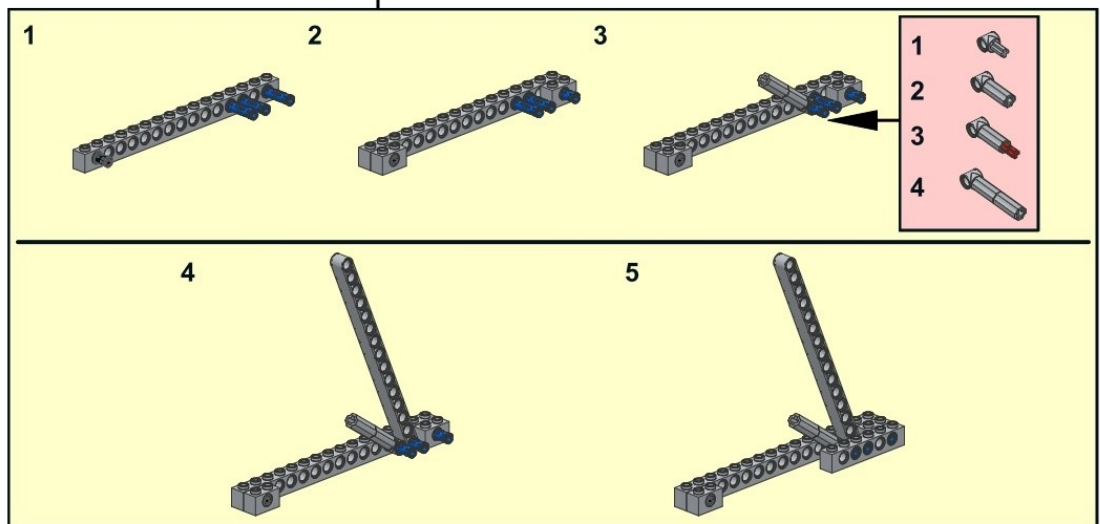
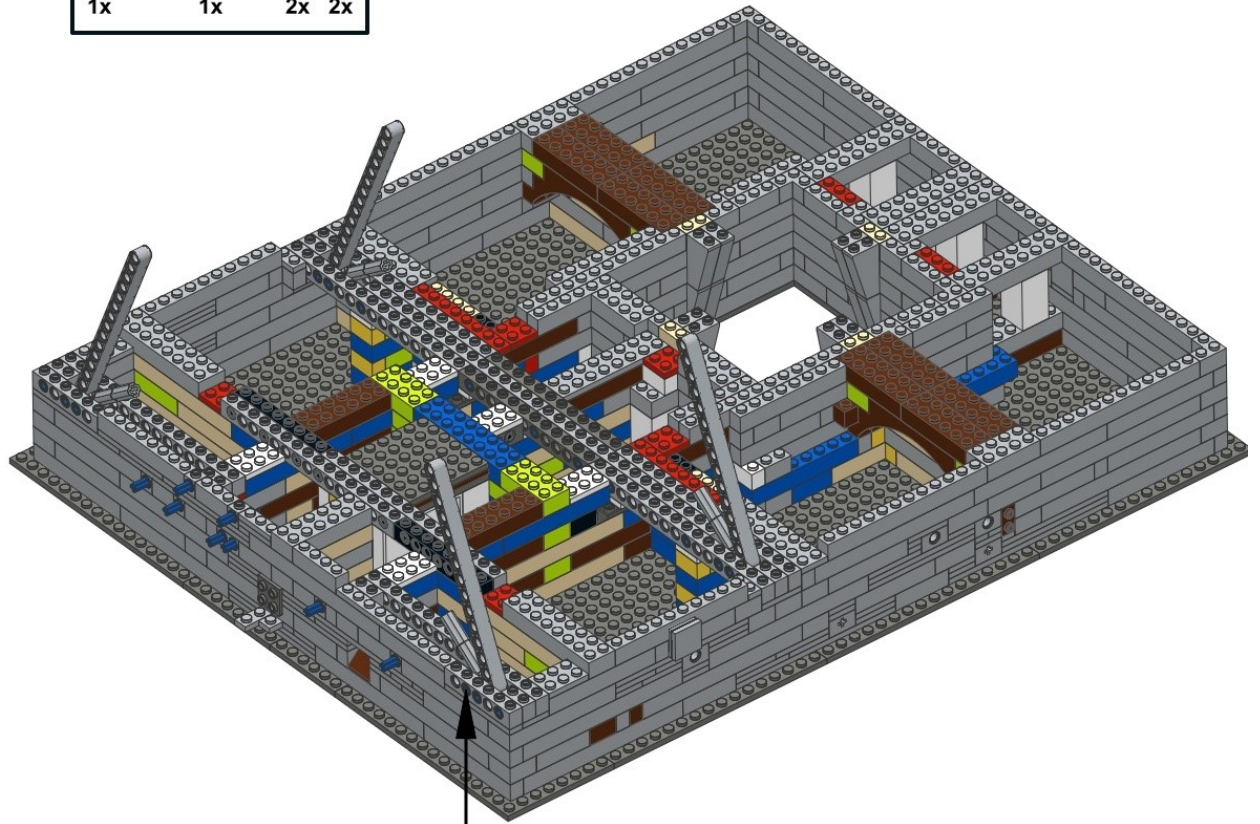
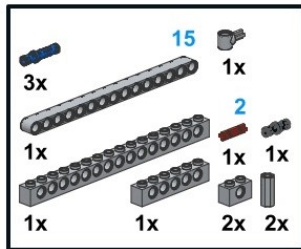

85

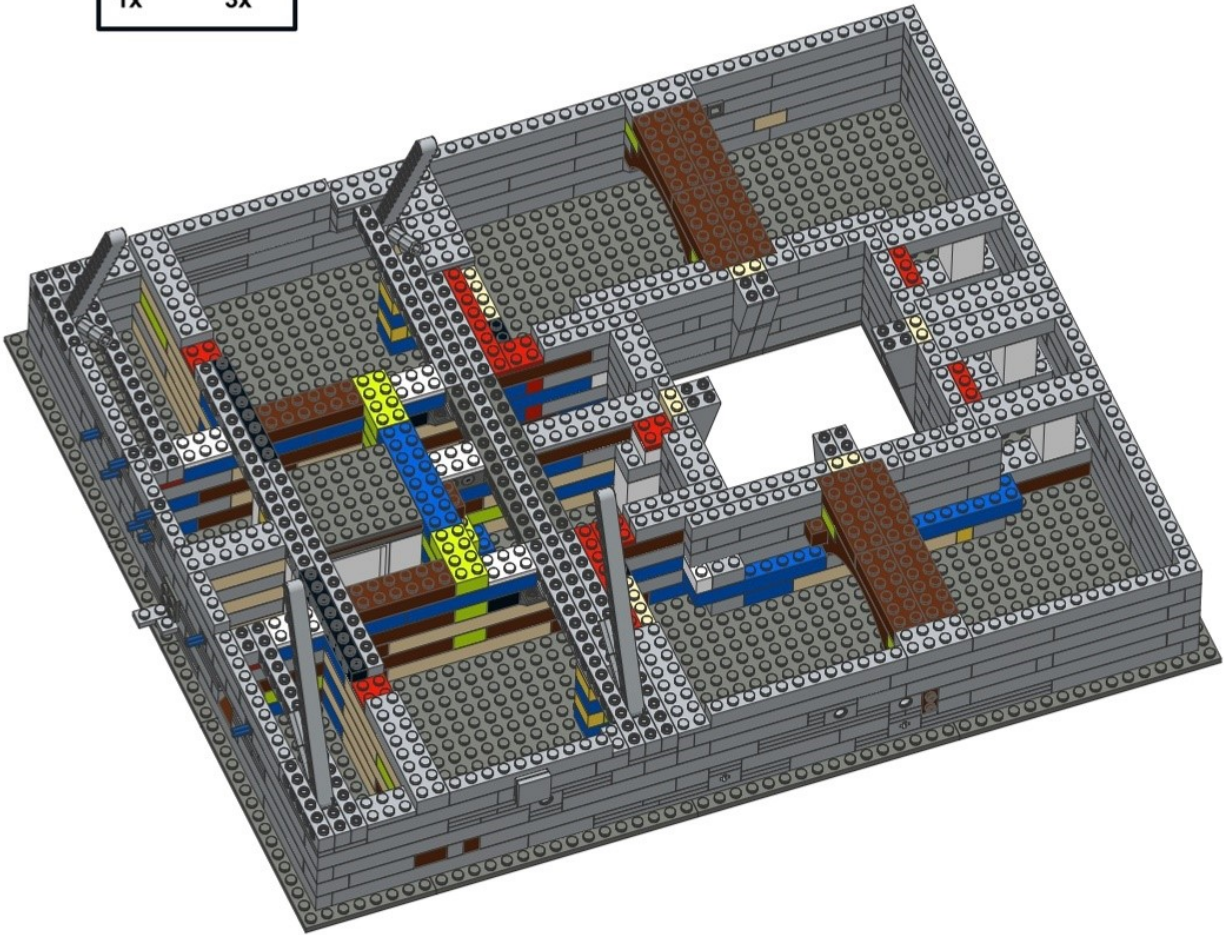
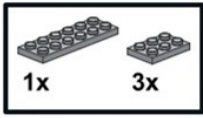

86

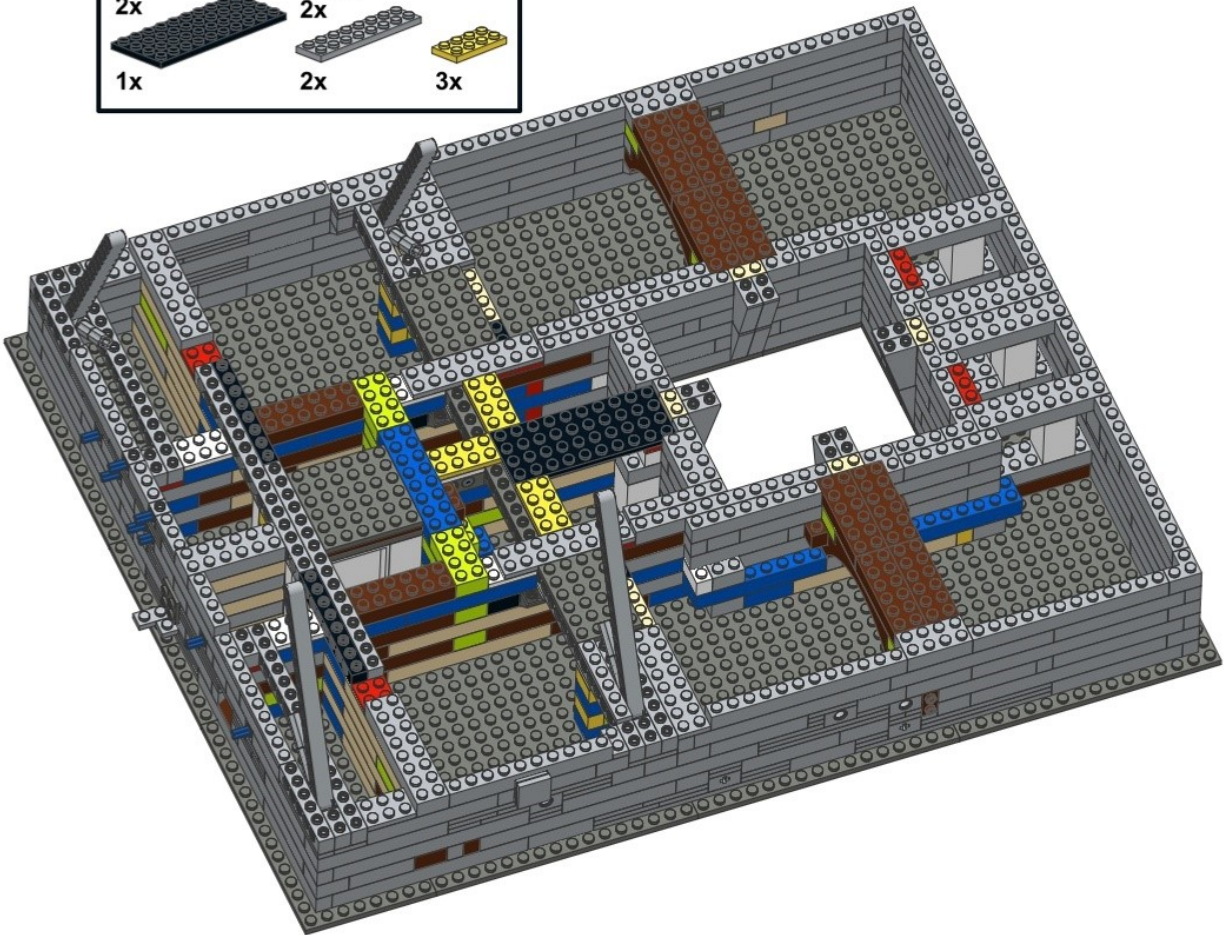
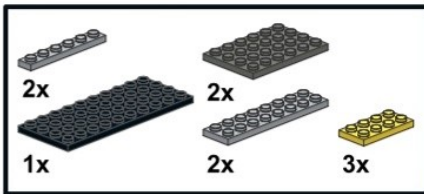



87

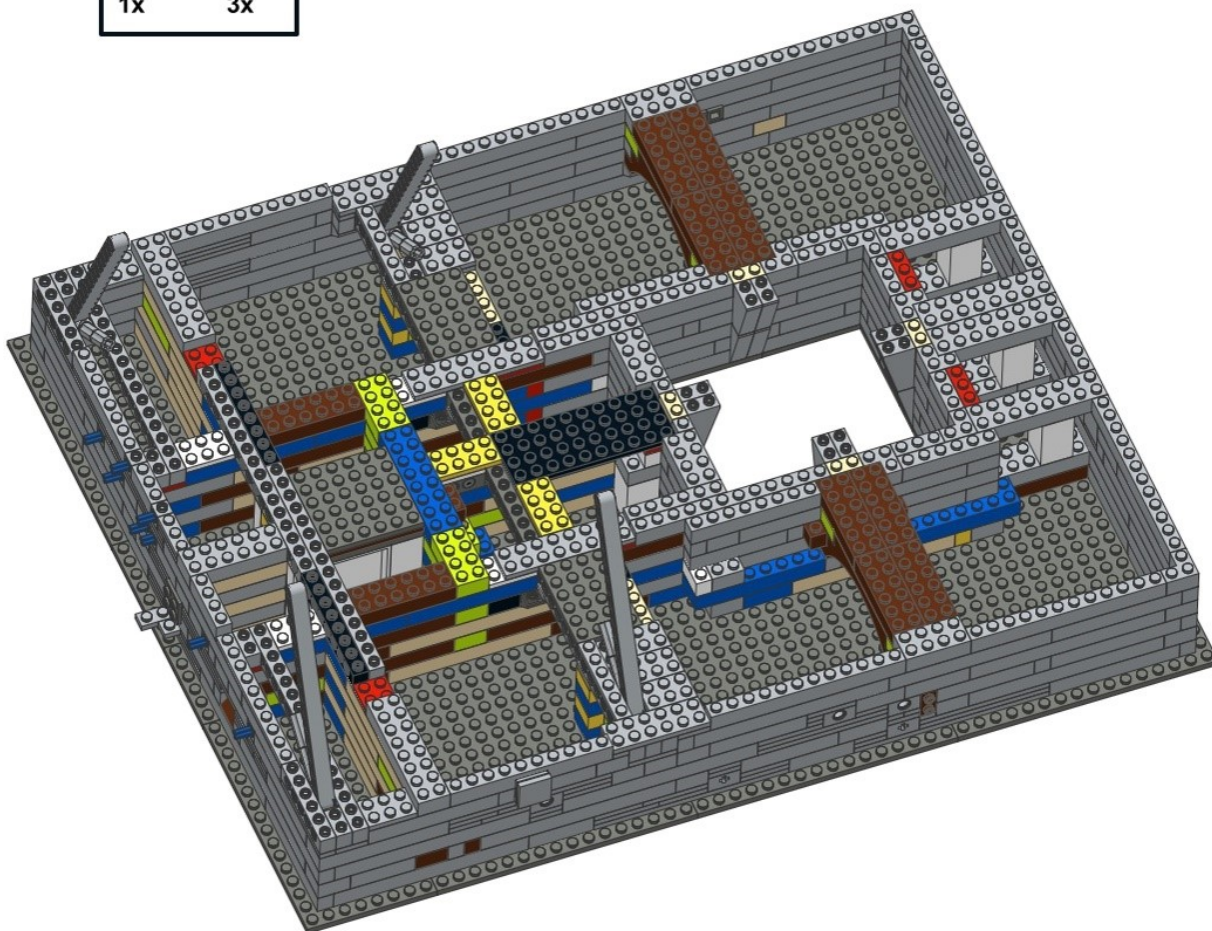
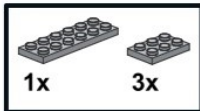

88

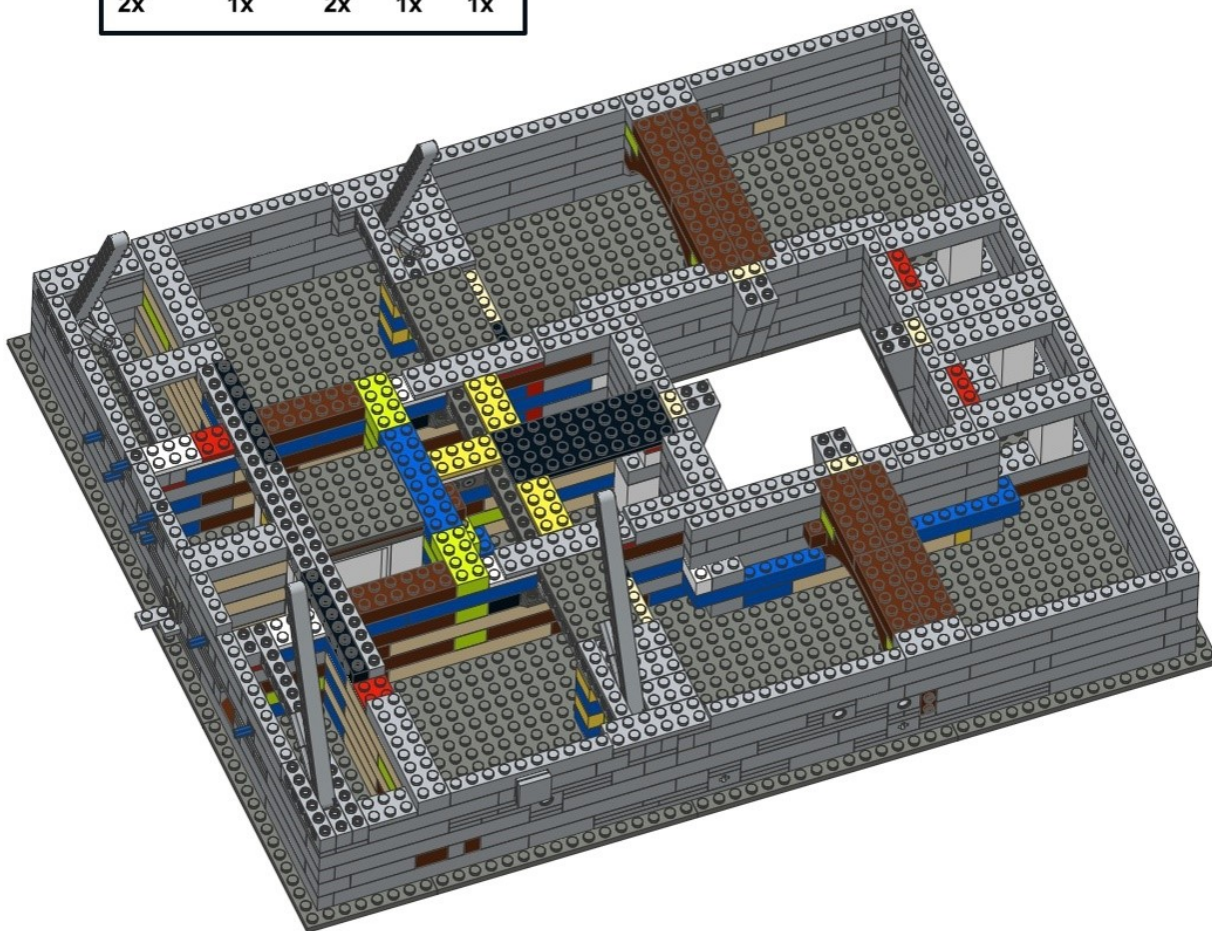
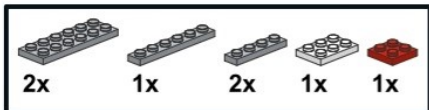



89

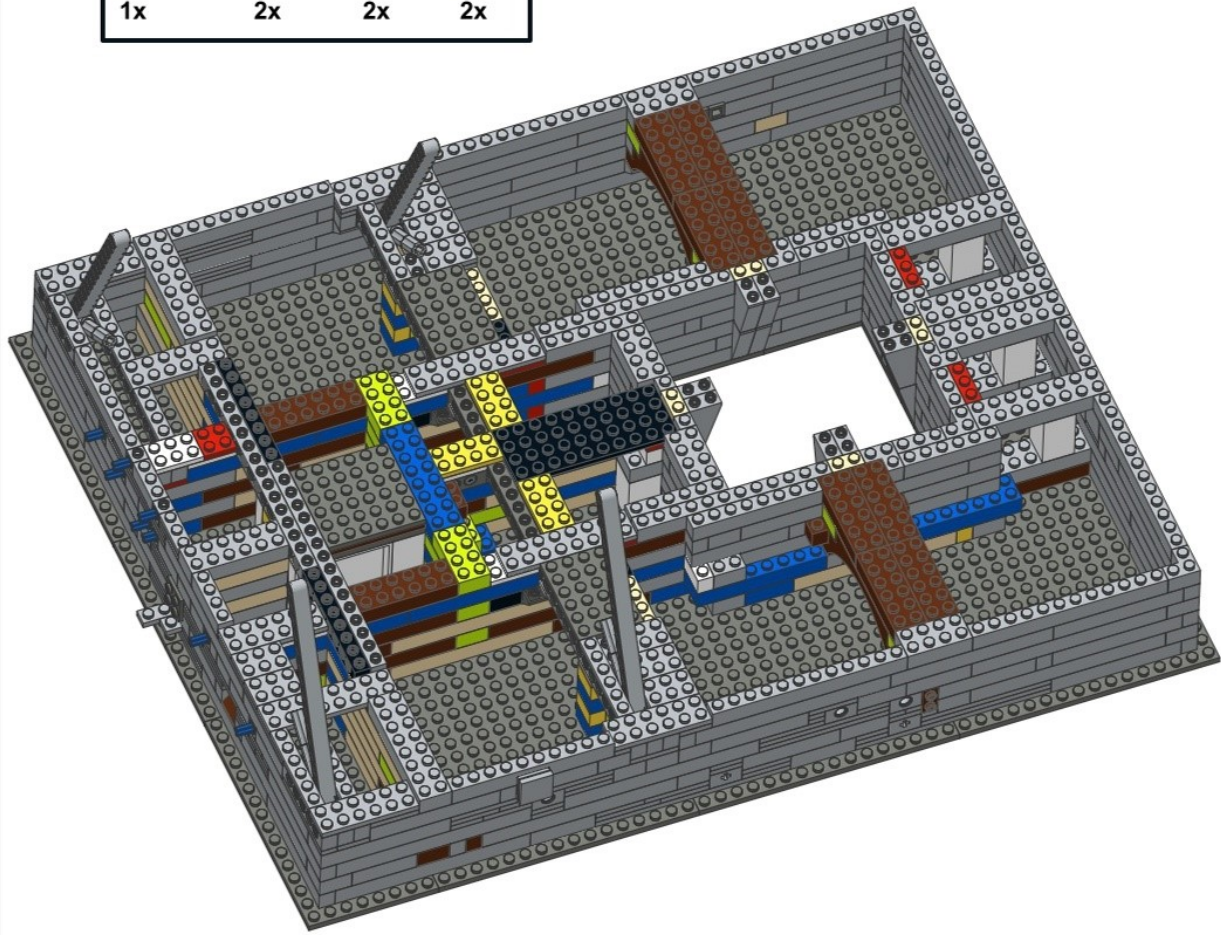
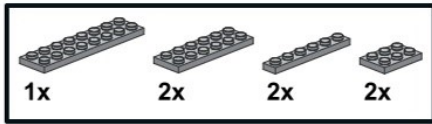

90

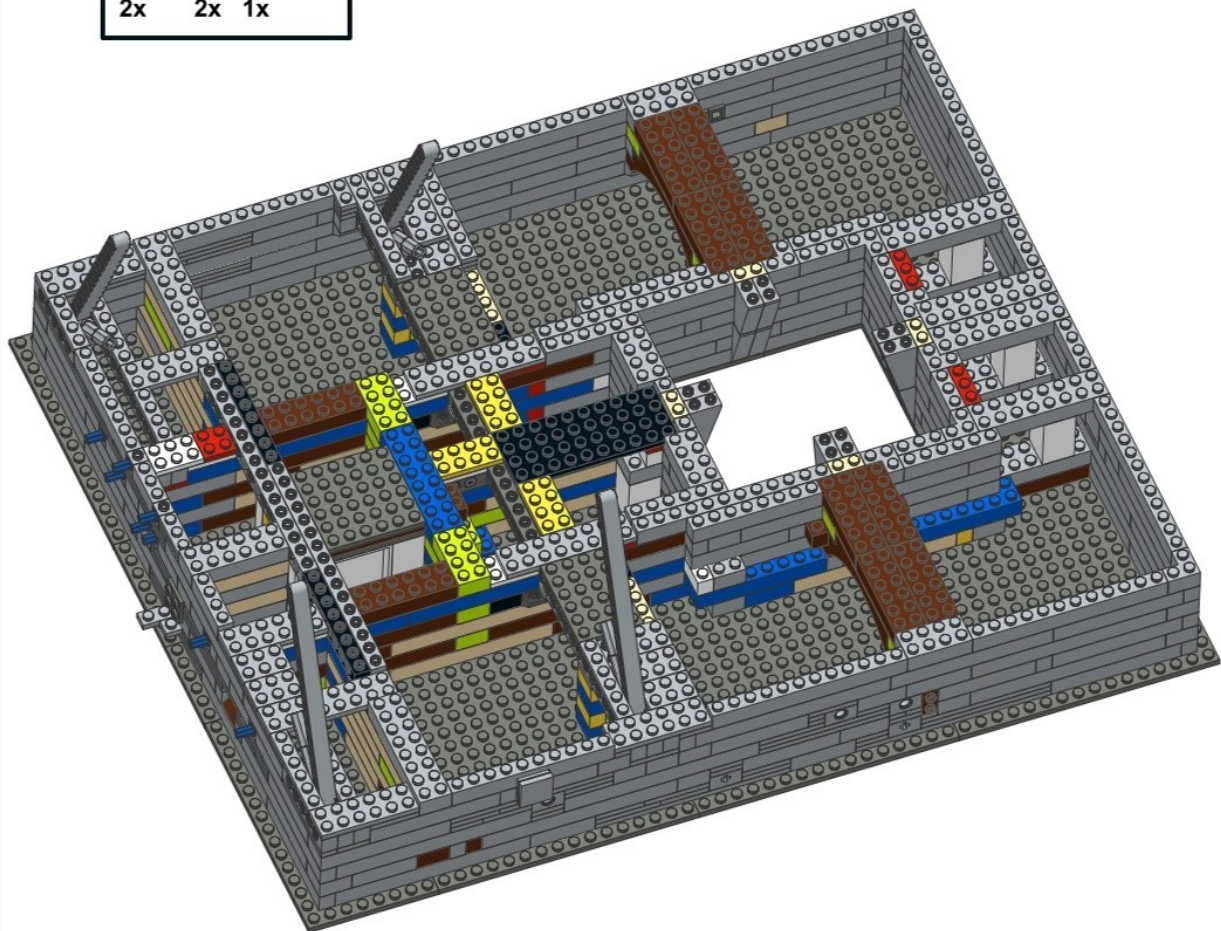
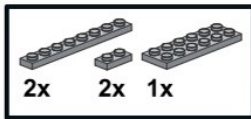



# 91

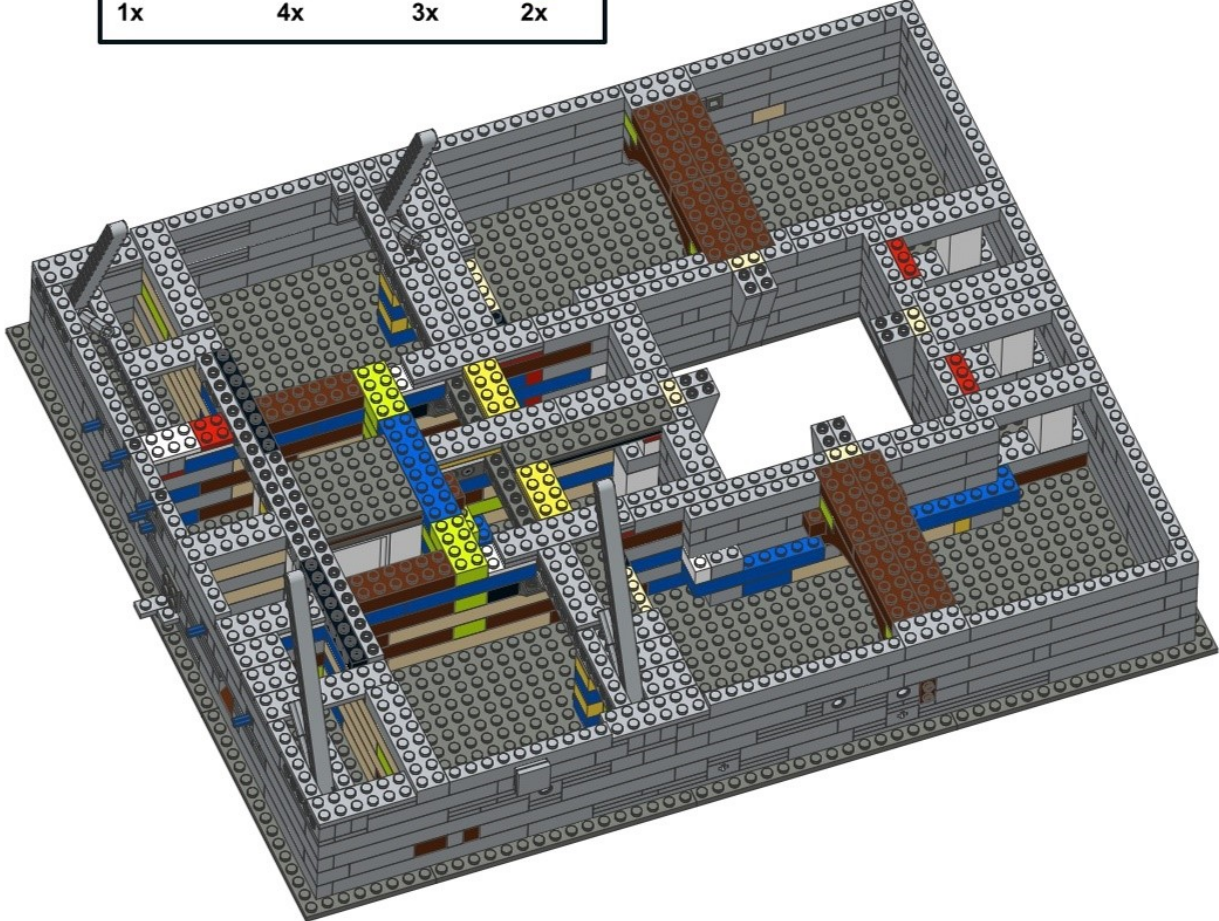
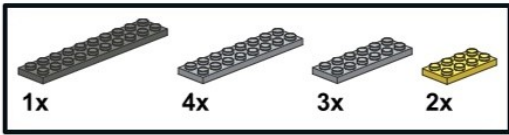

# 92

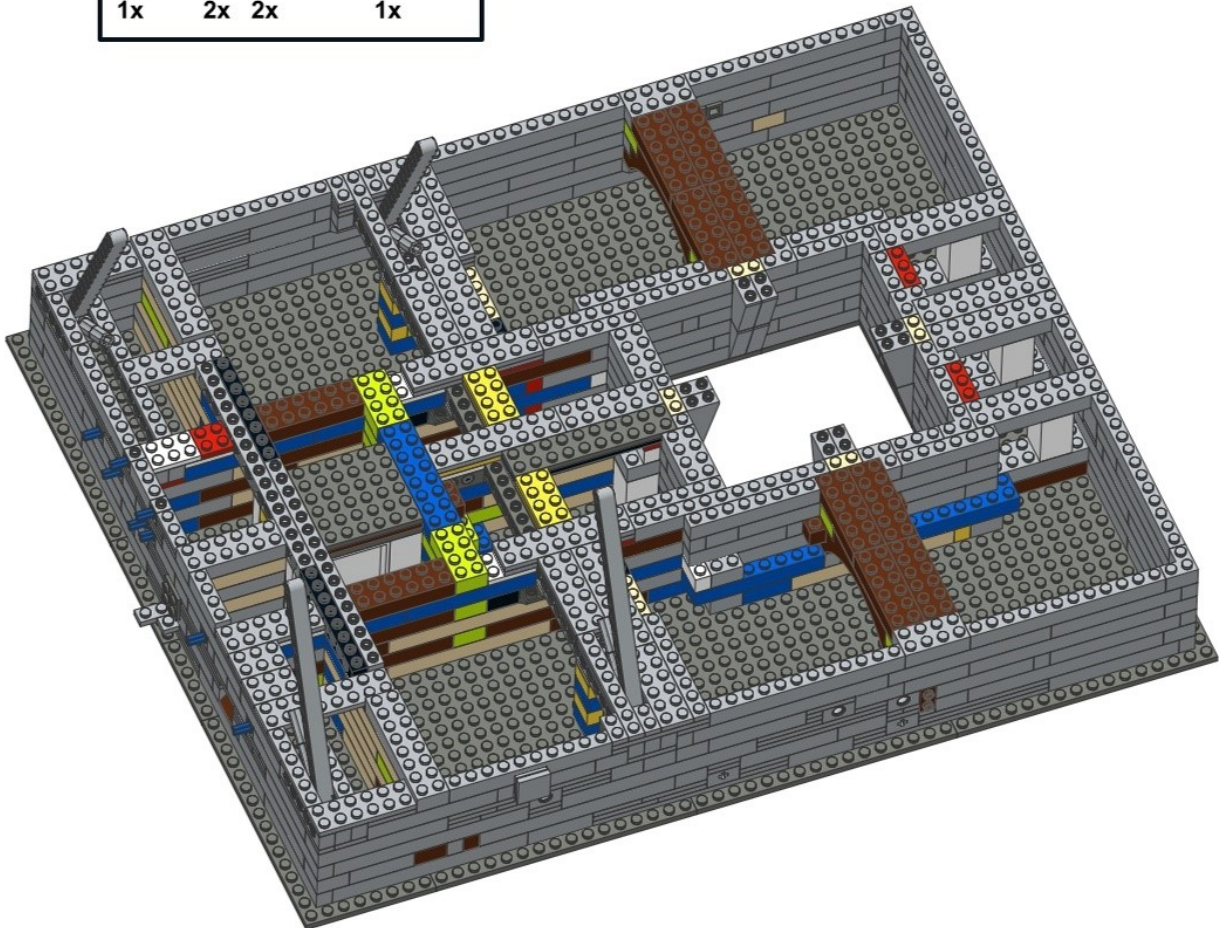
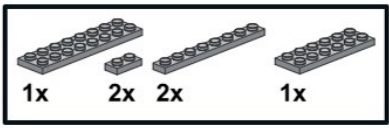



93

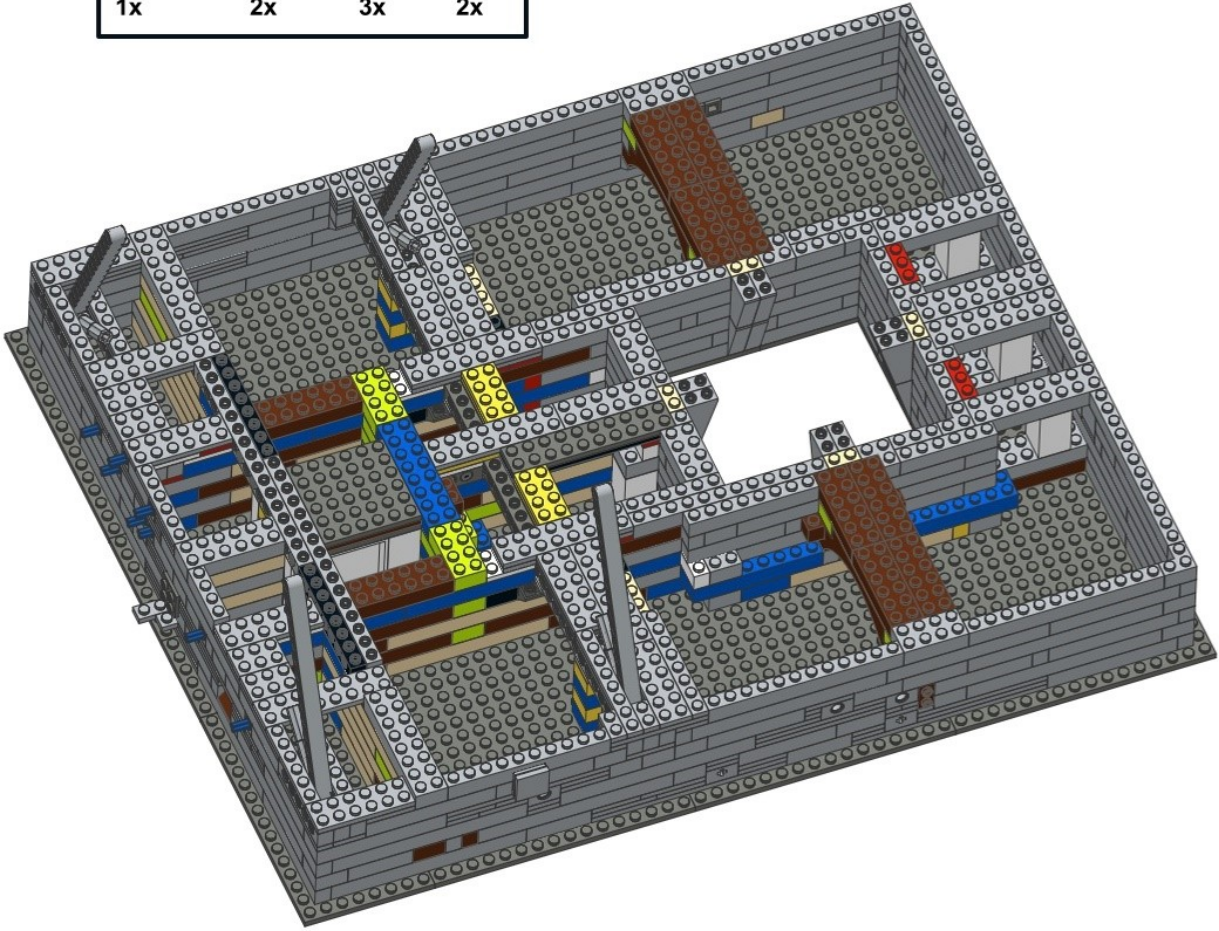
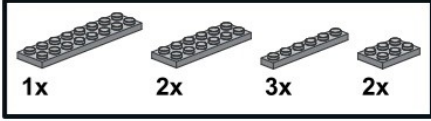

94

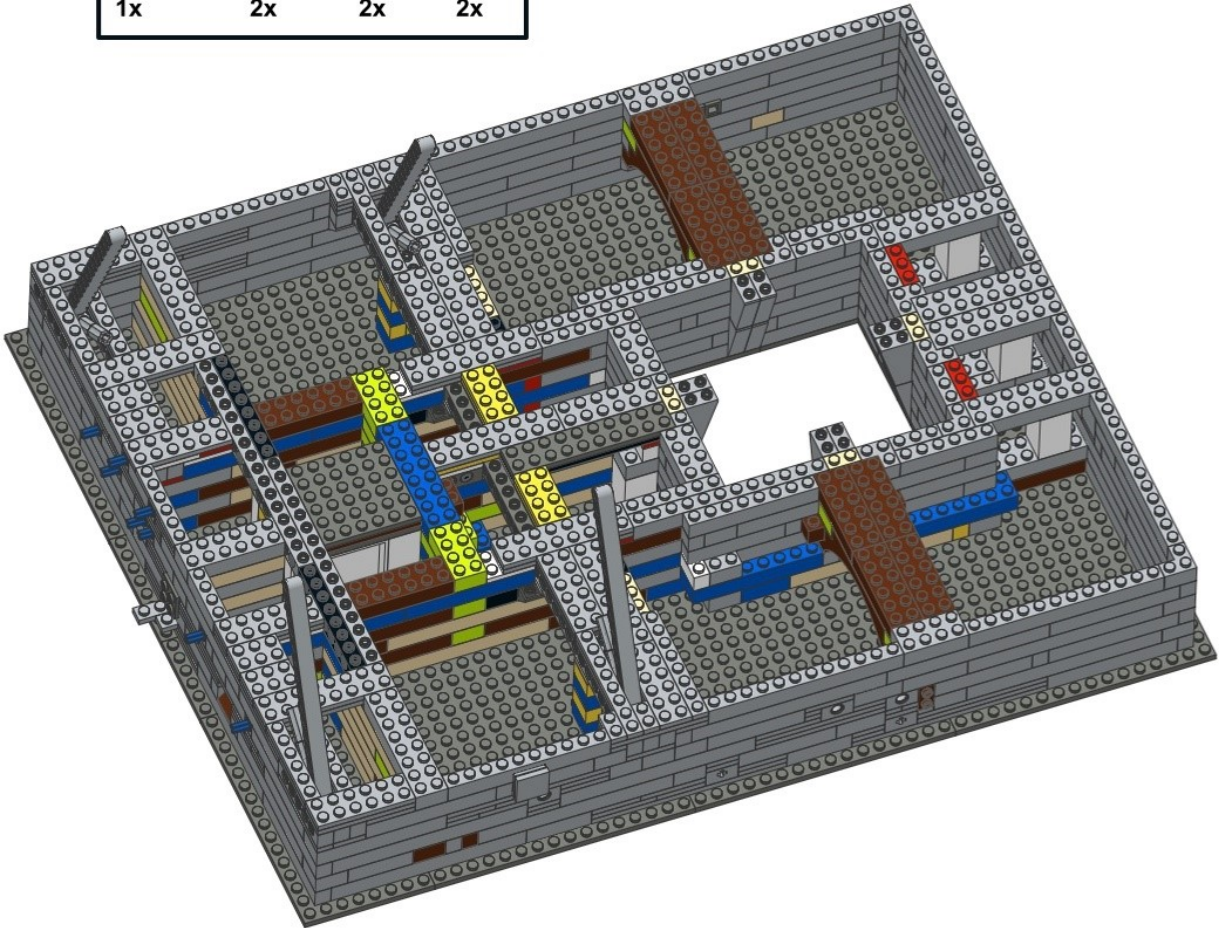
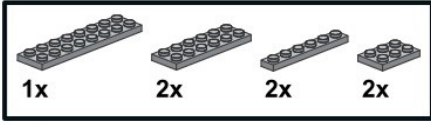



95

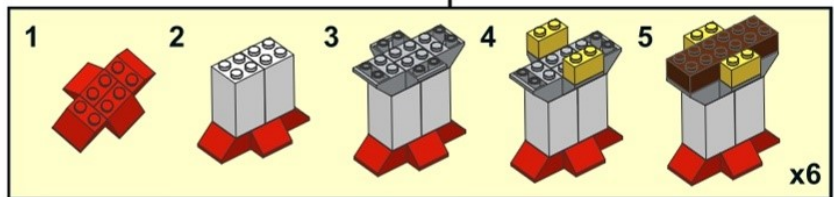
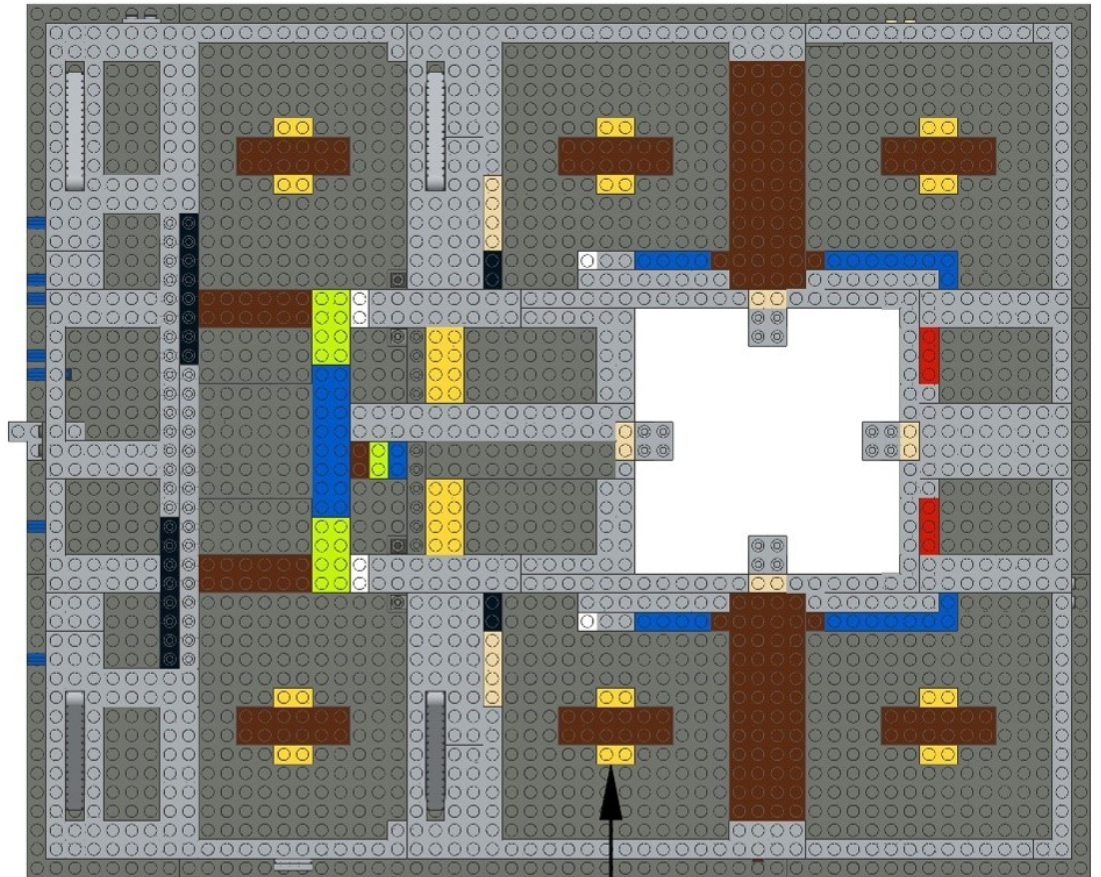
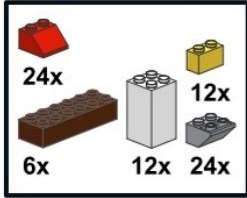



96

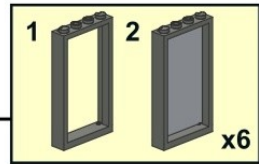
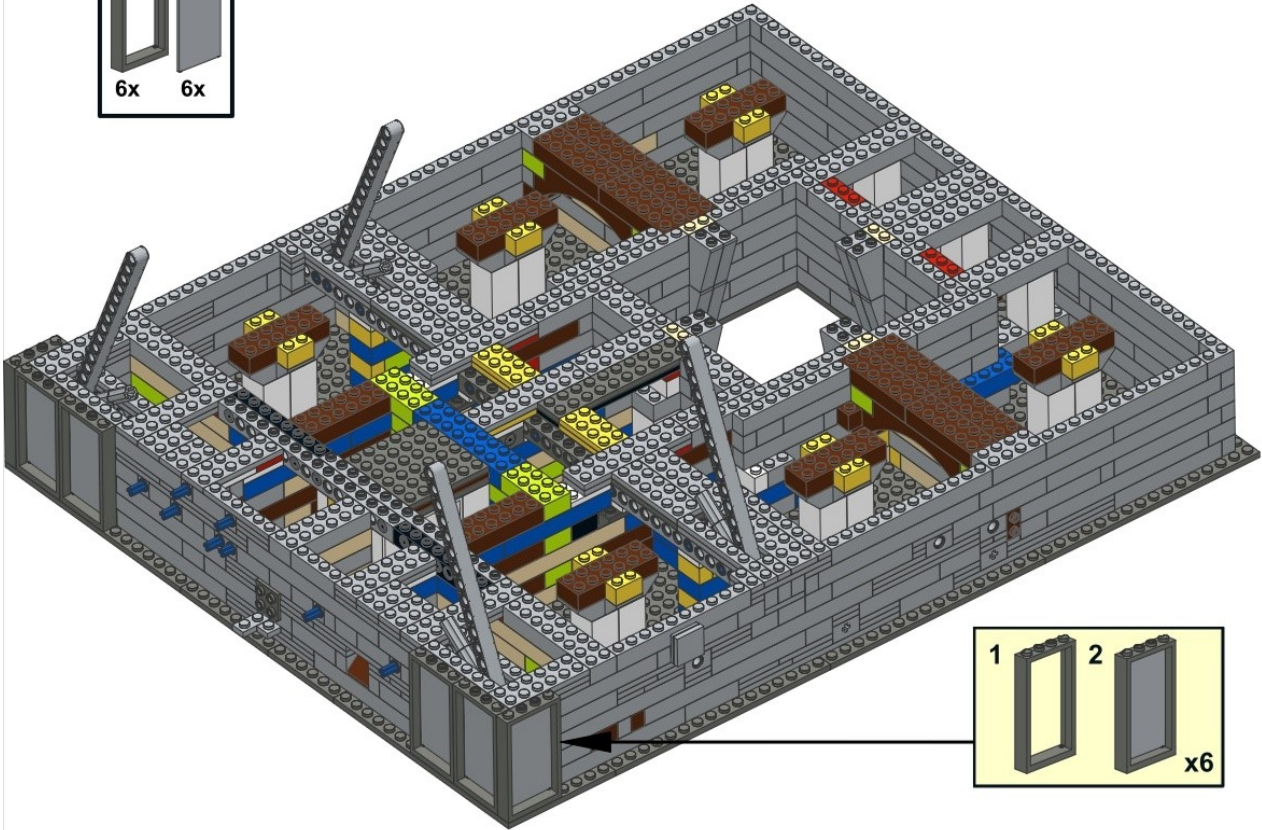
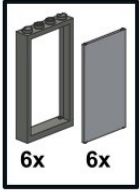

97

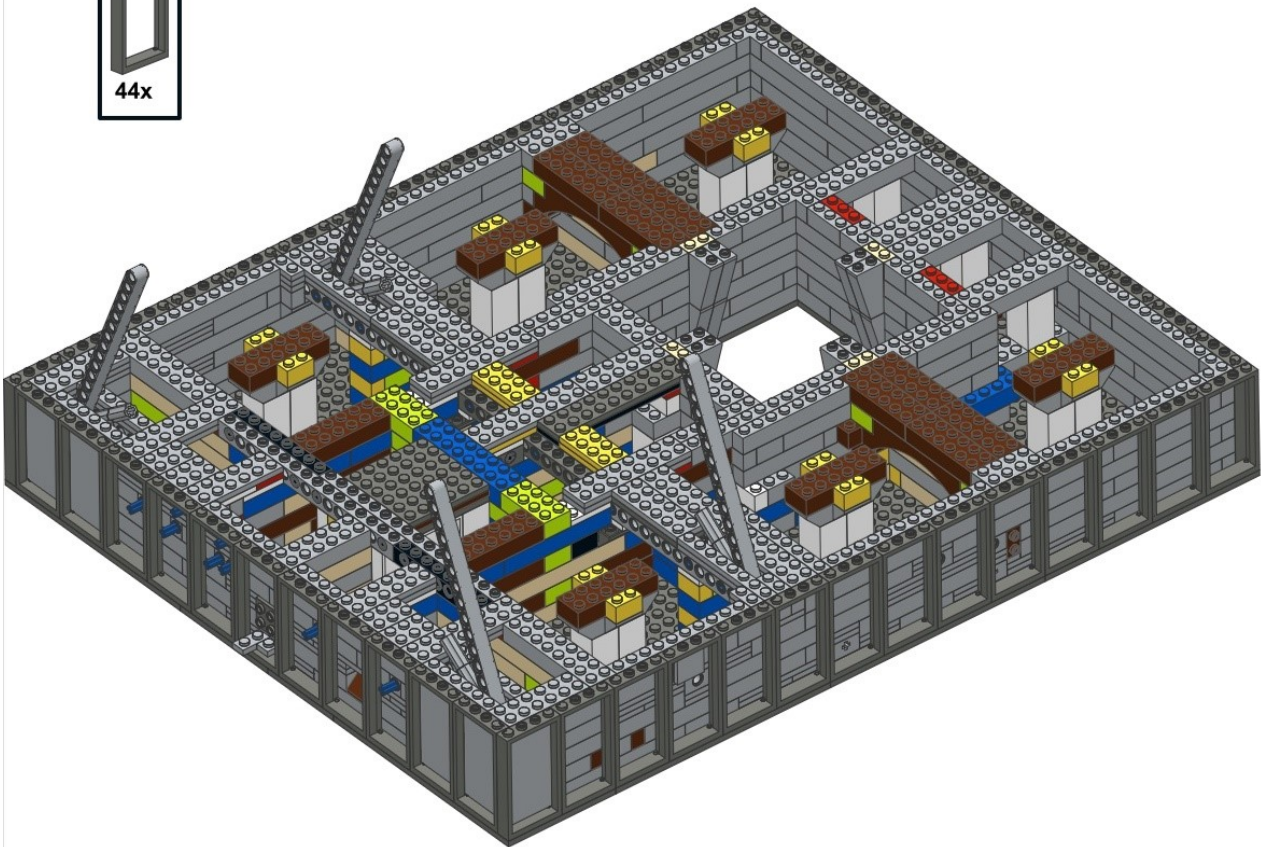



98

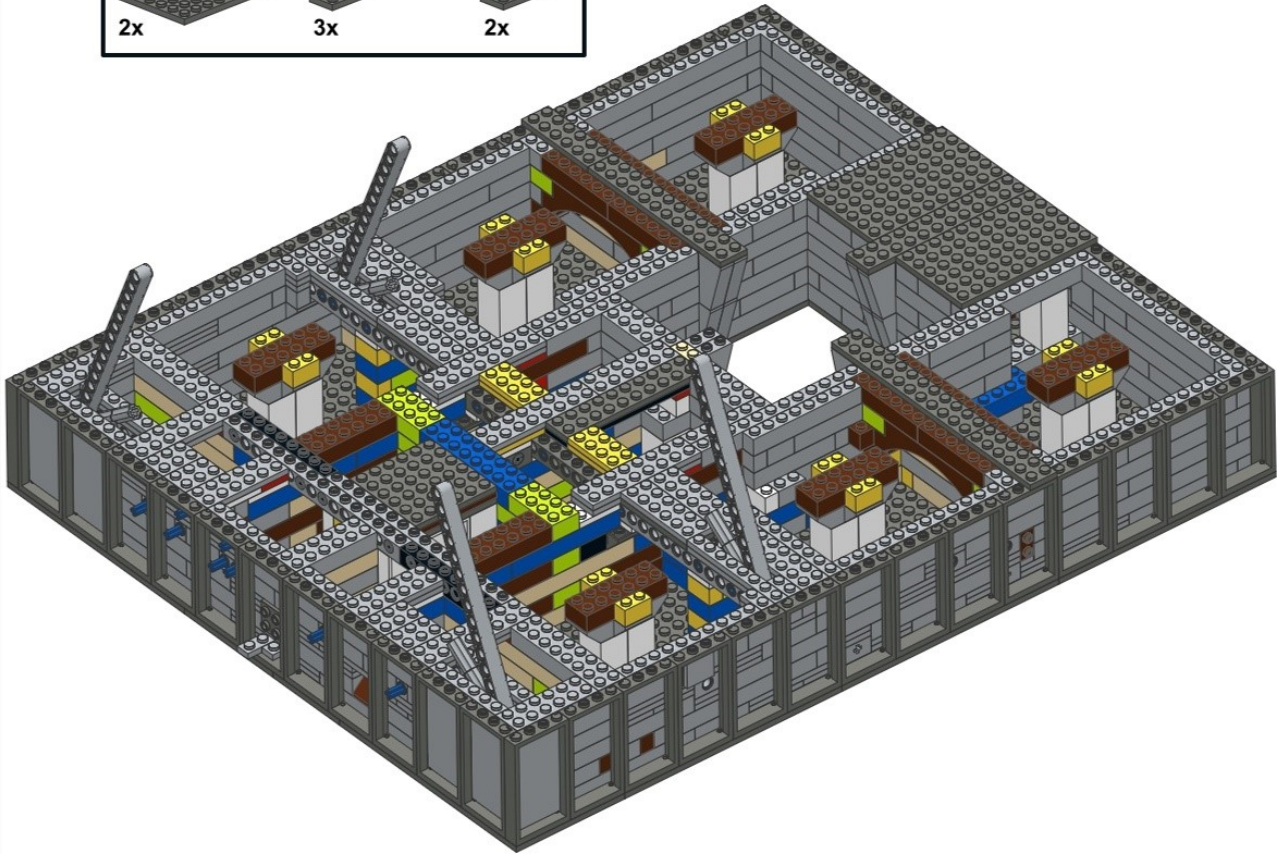
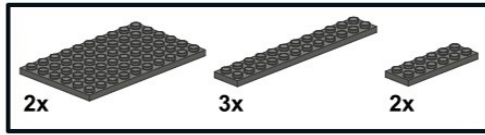

99

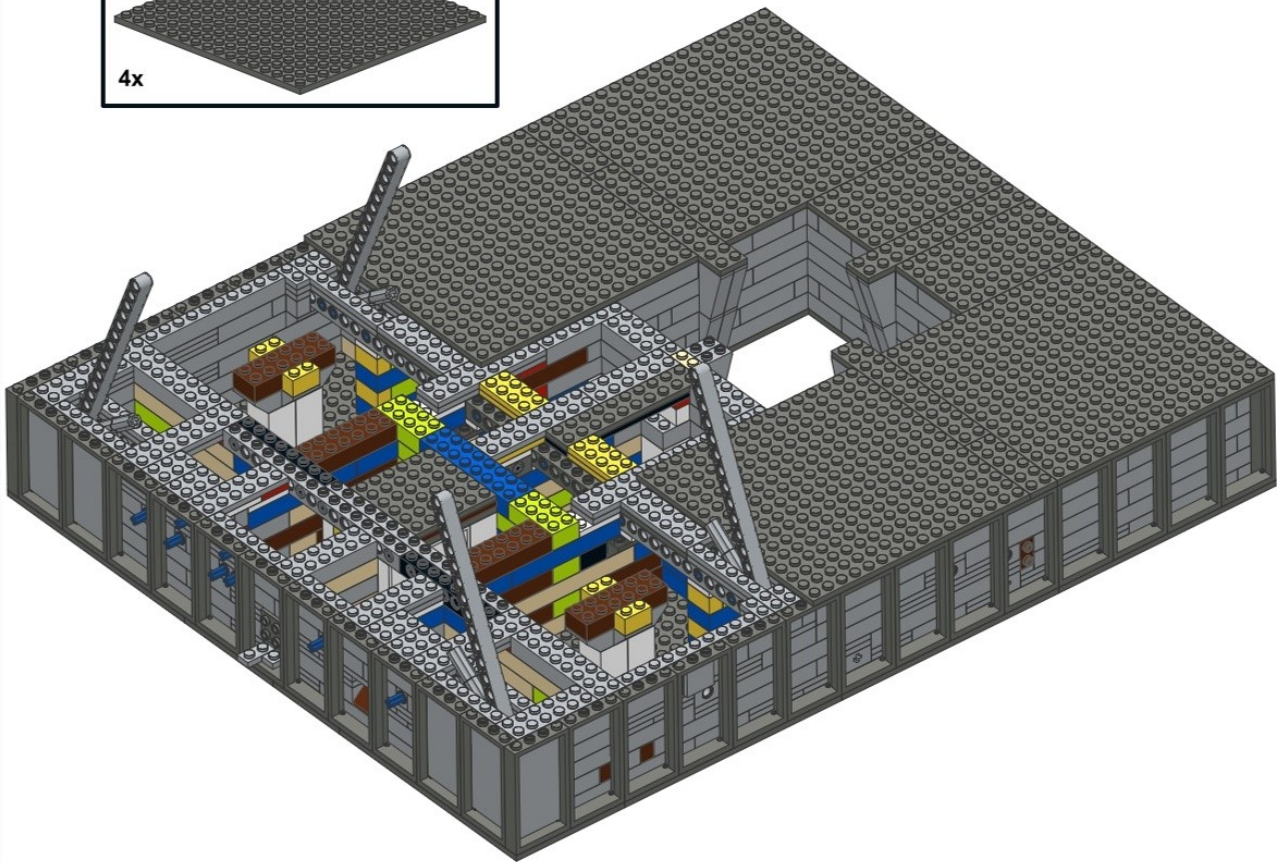
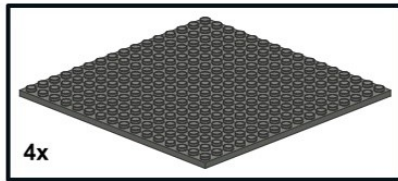



100

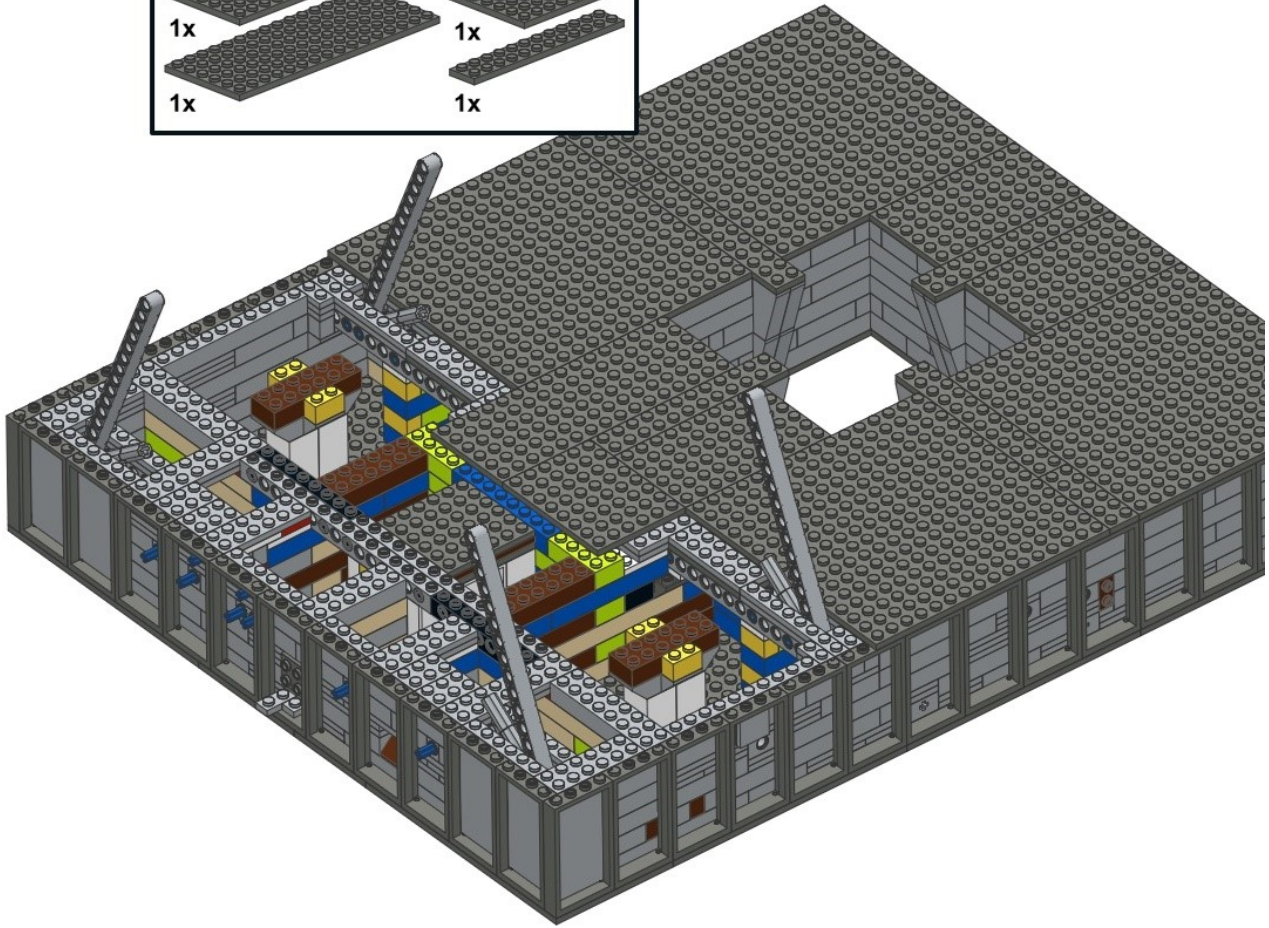
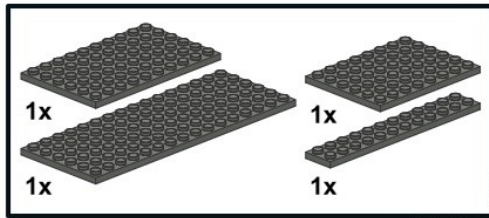

101

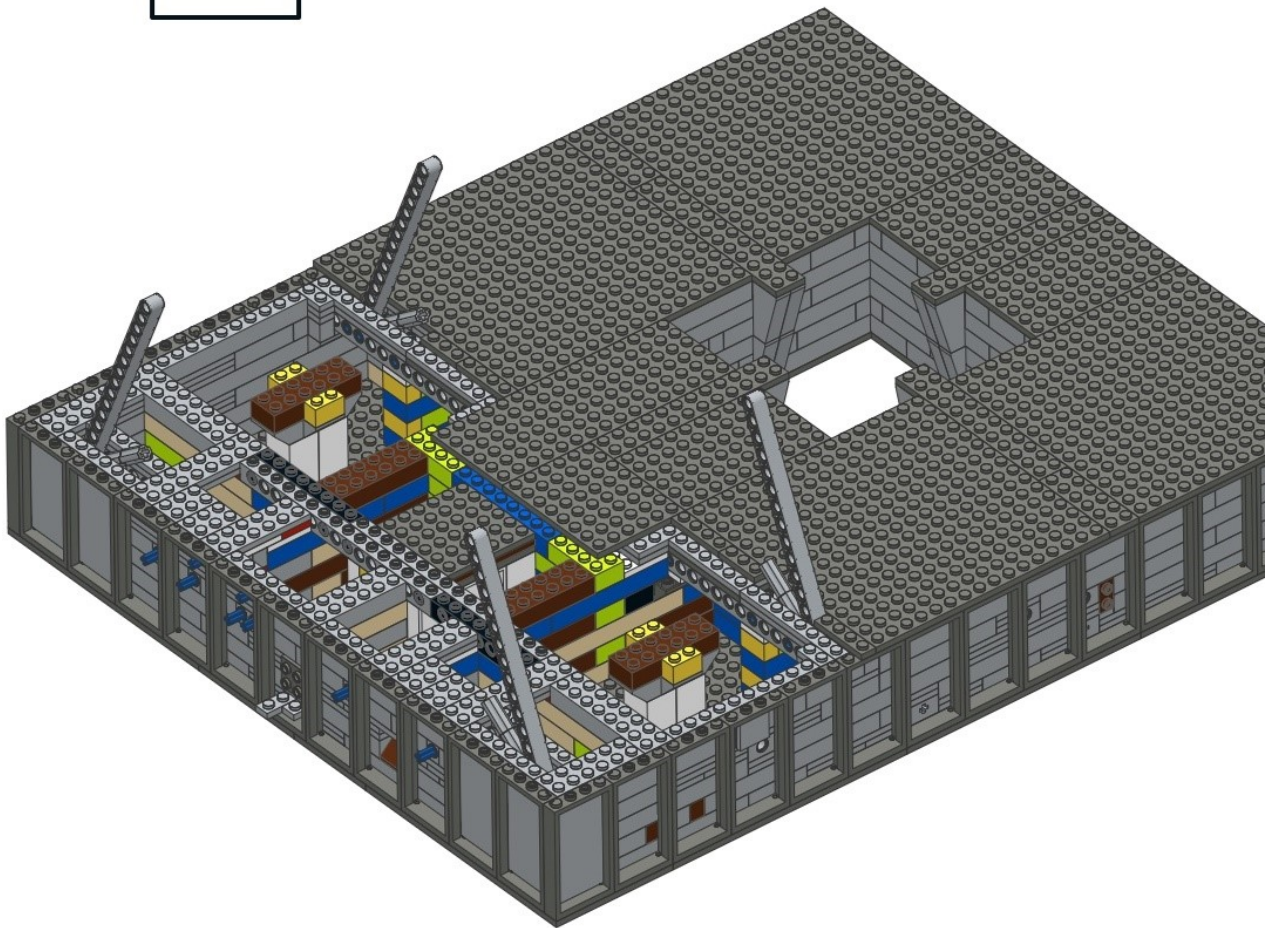
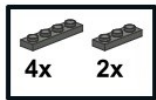



102

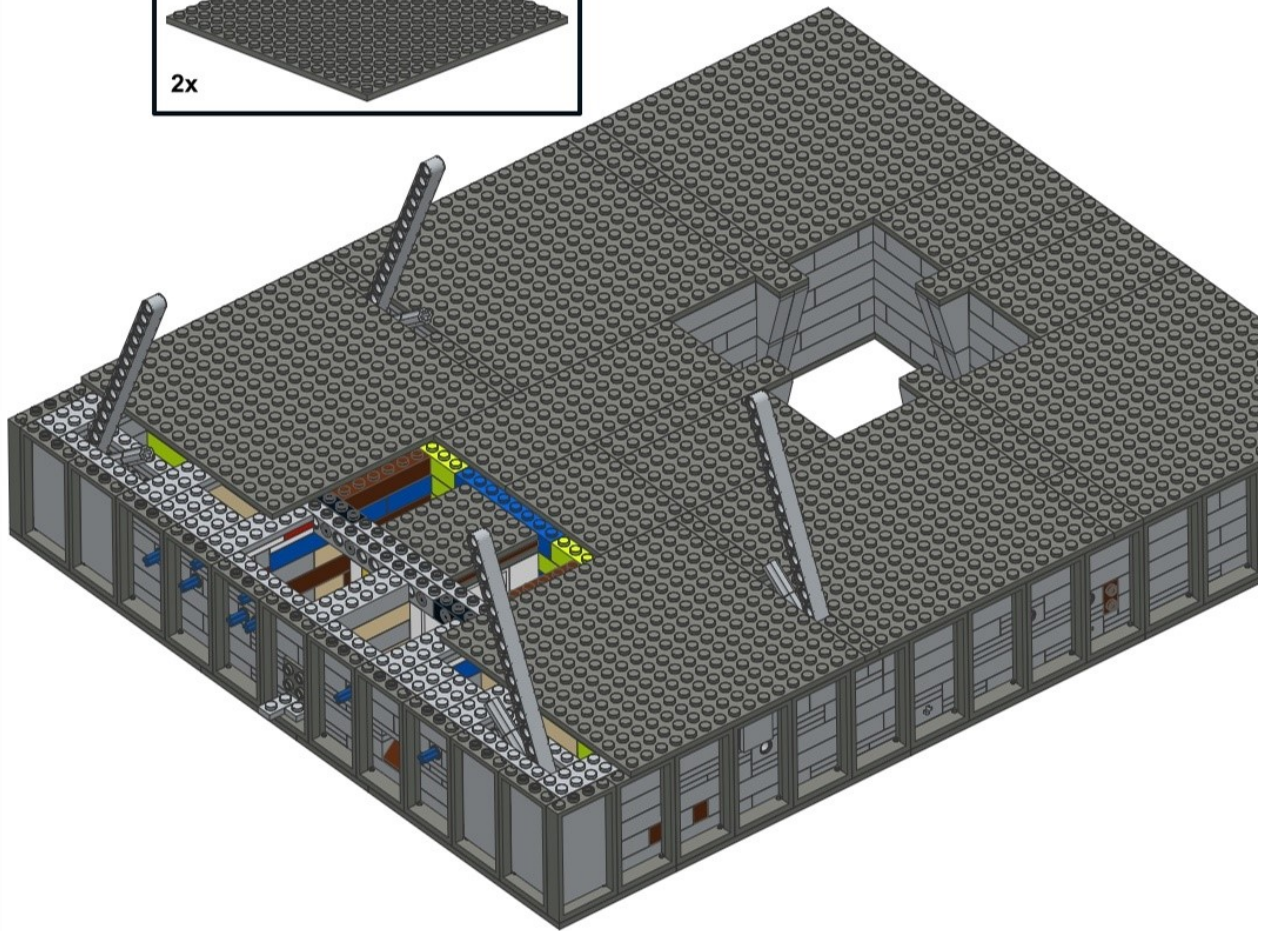
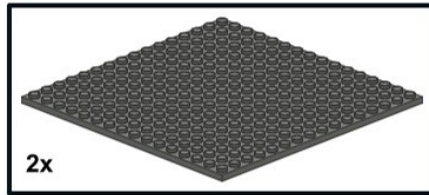

103

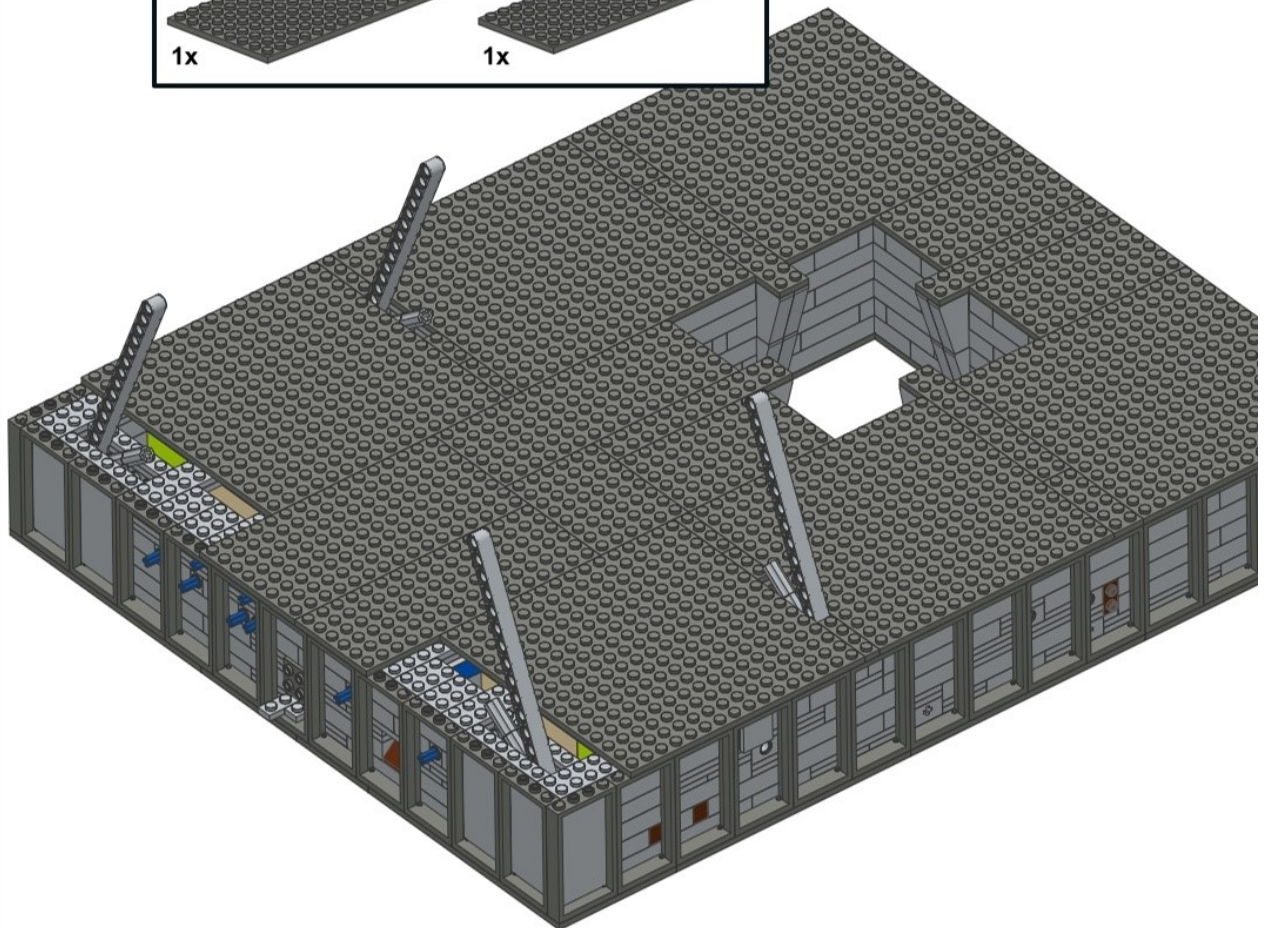
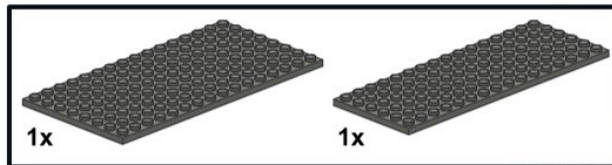



104

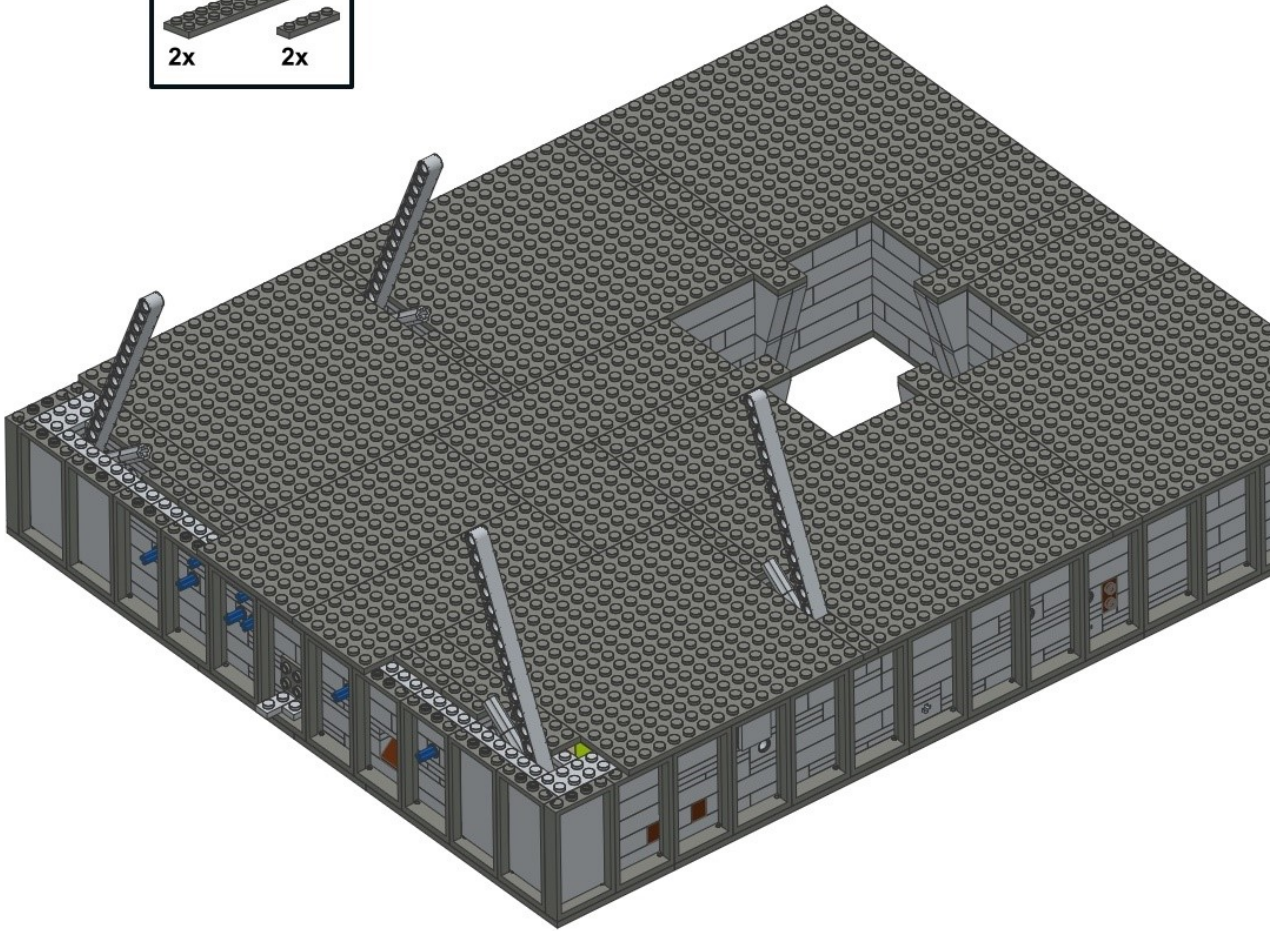
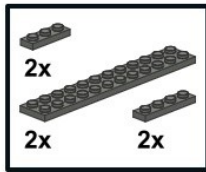

105

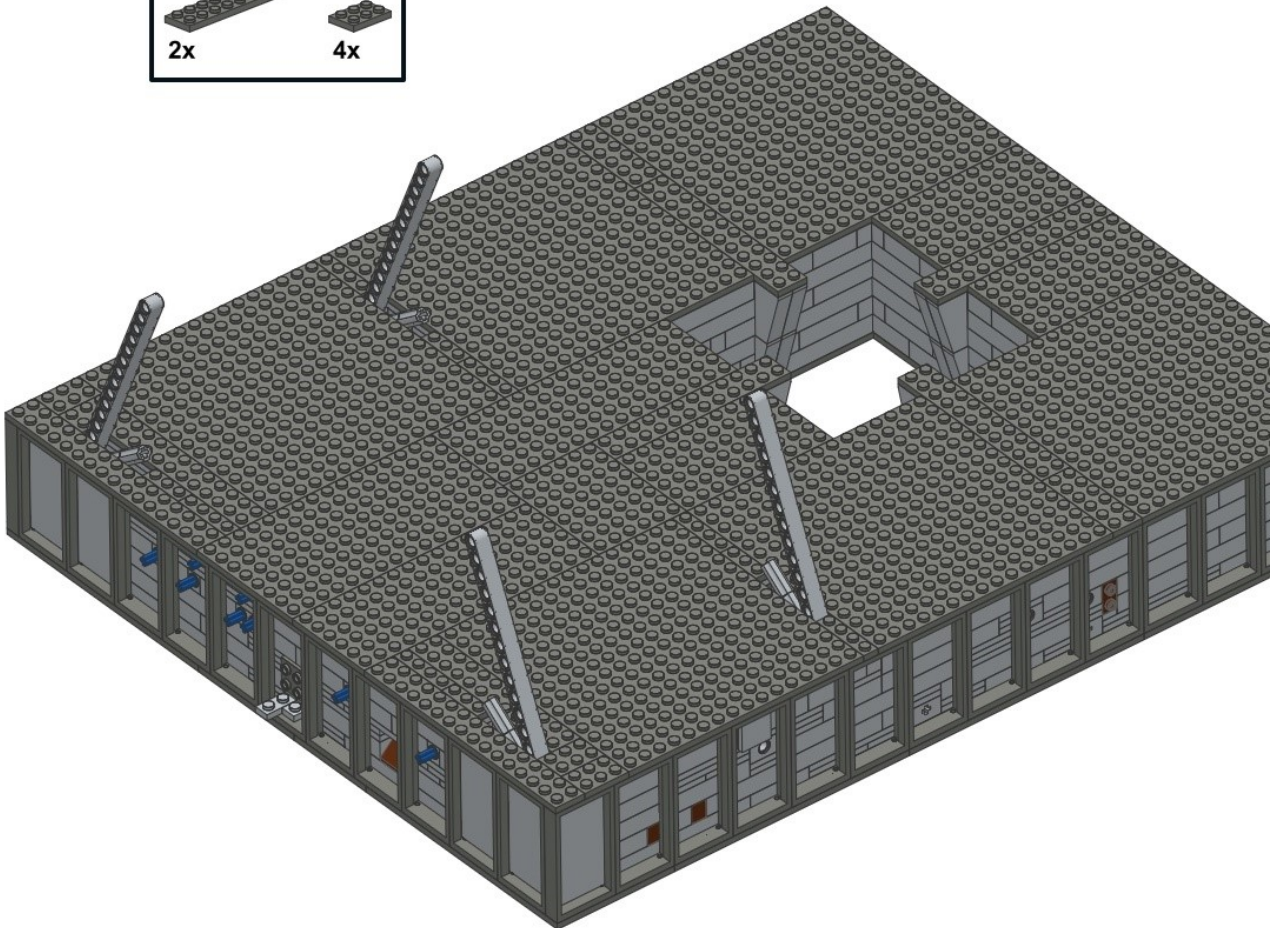
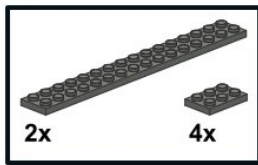



# 106

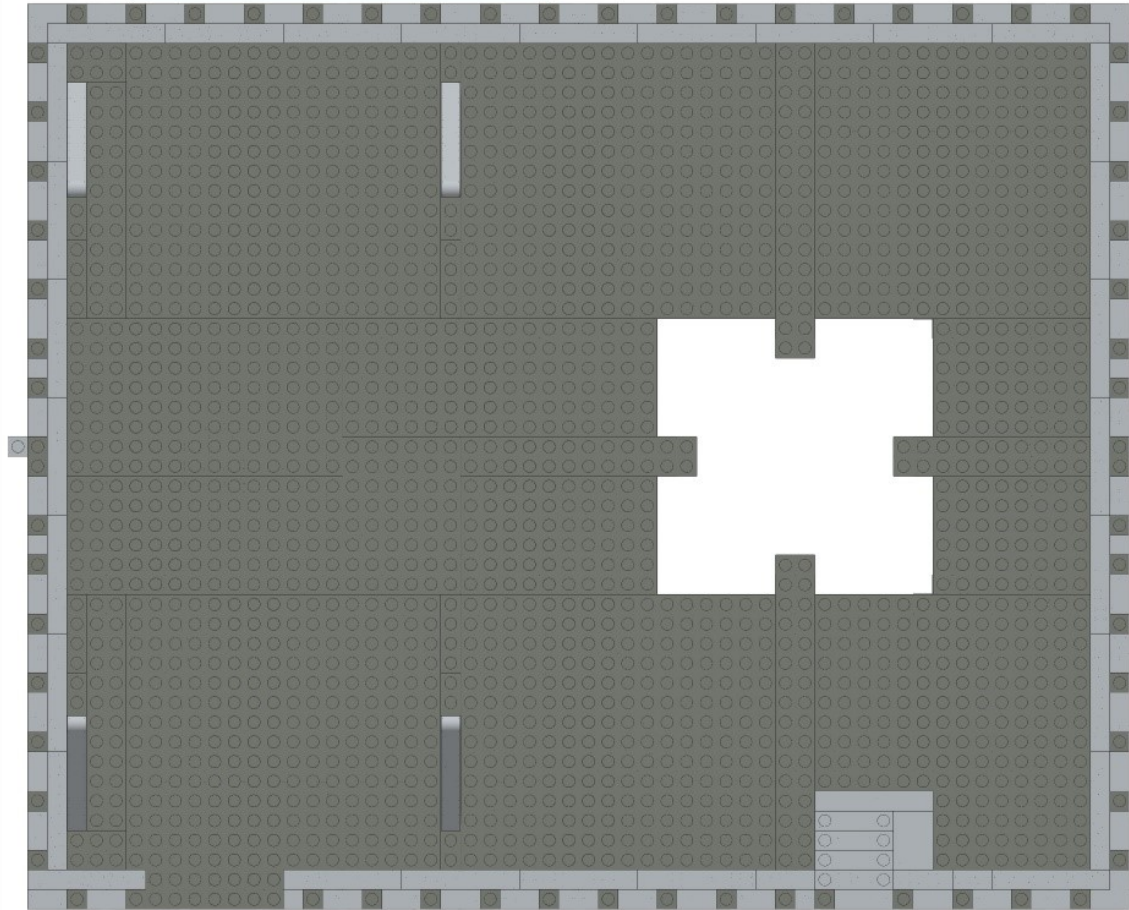
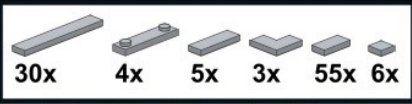

# 107

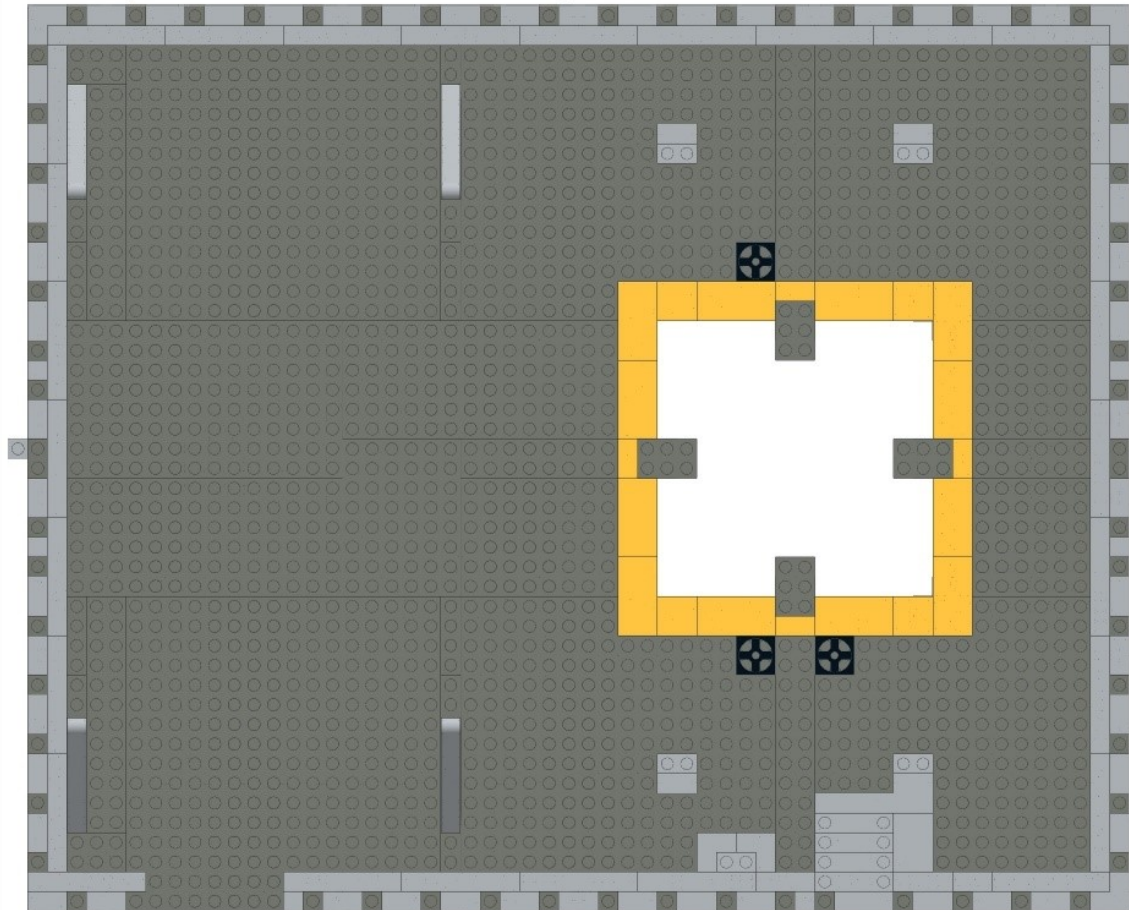
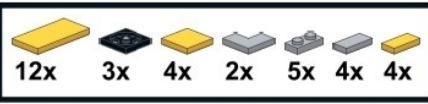



# 108

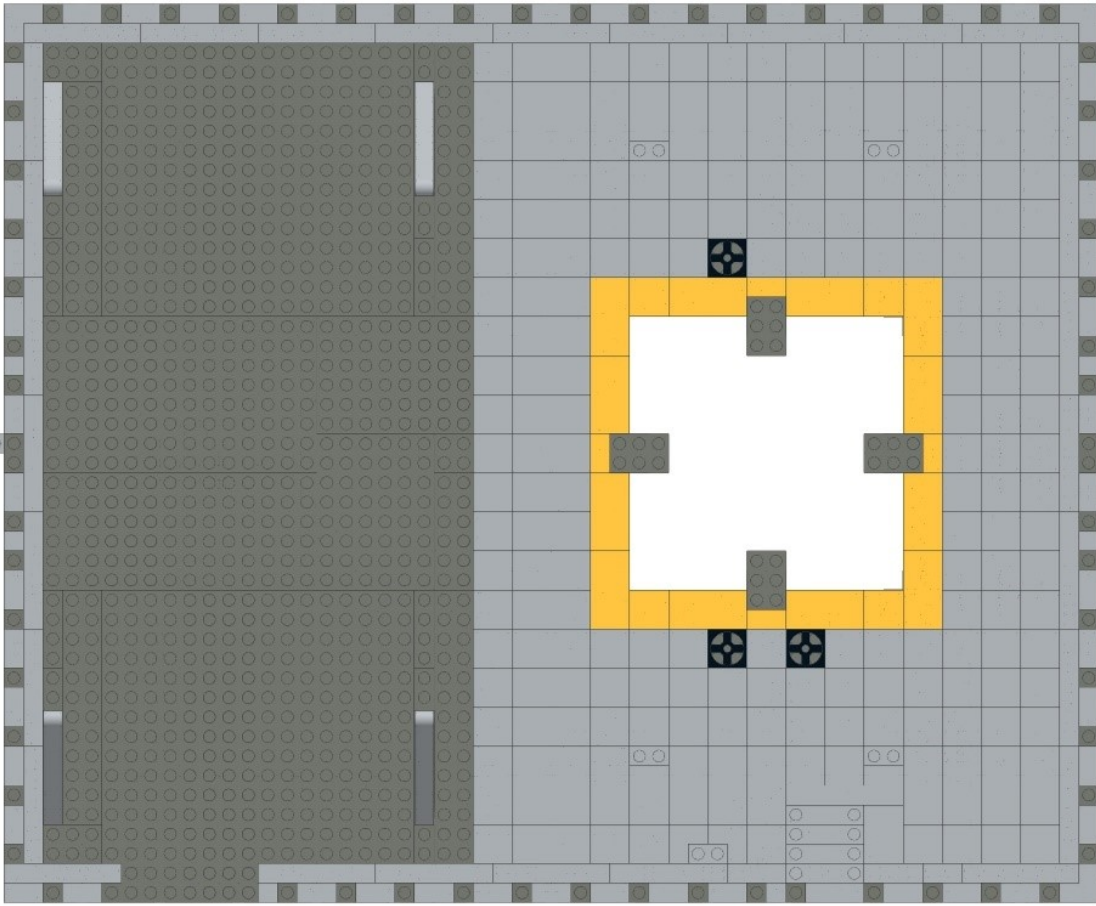



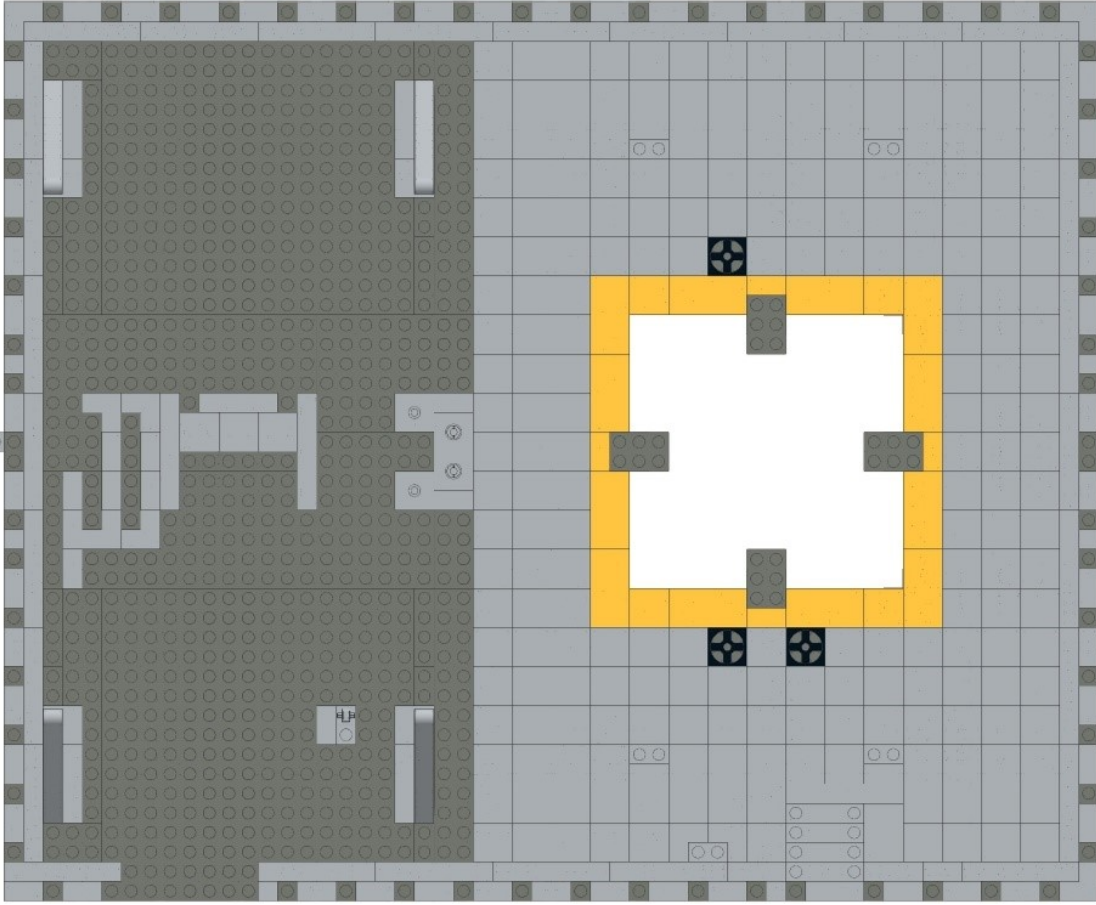
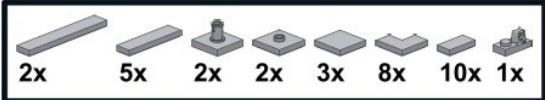

# 109

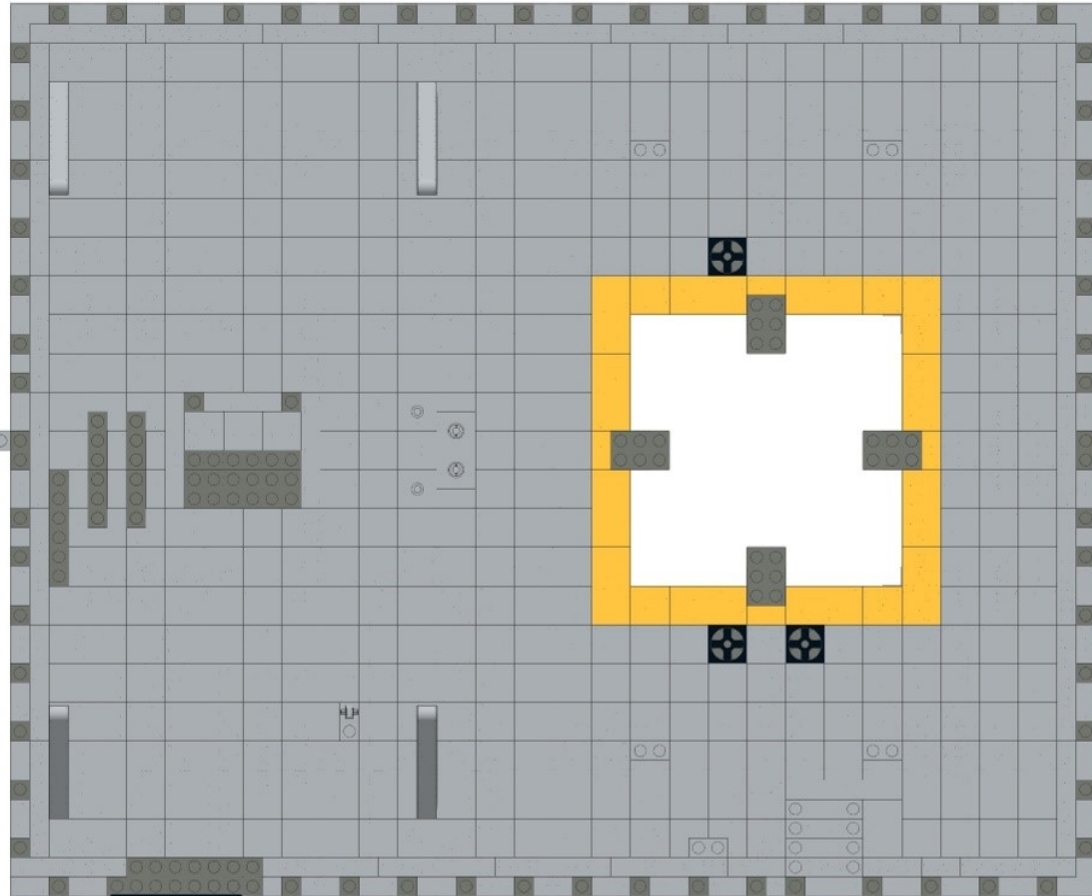

110  190x



111  27x 54x

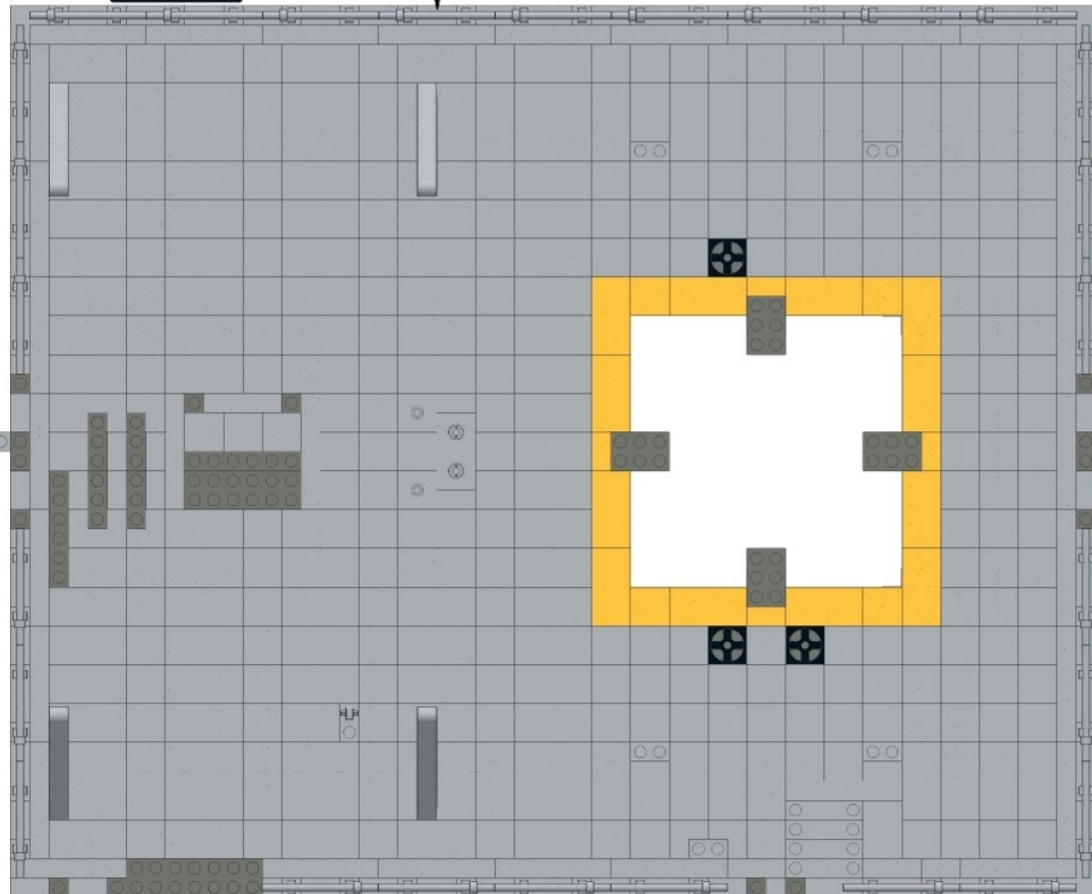

1  2   x27





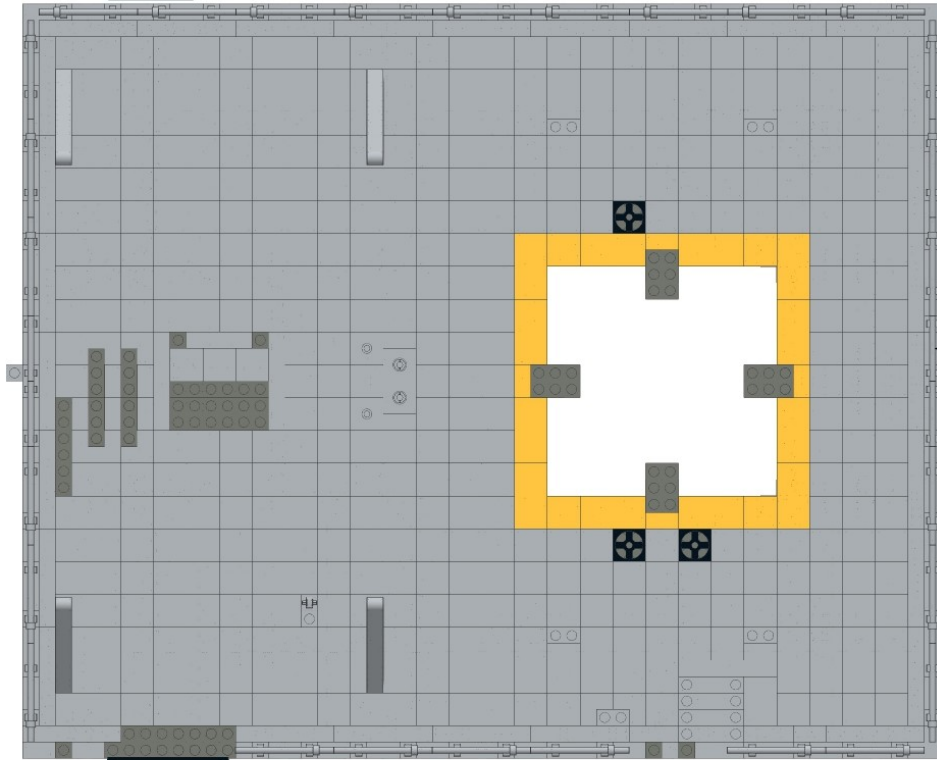

112   
4x 8x



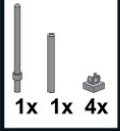

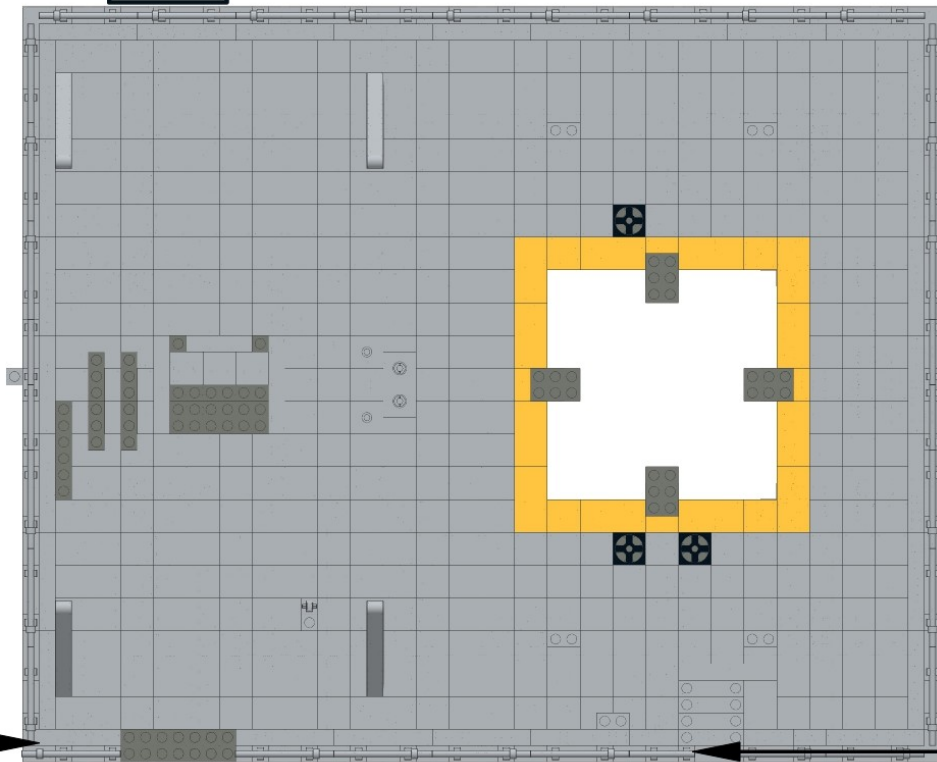
1   
2   
x4

113   
1x 1x 4x



1   
2 

1   
2 

# 114

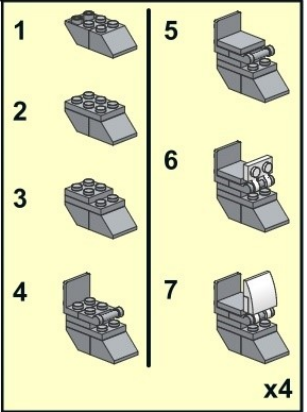
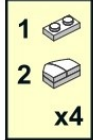
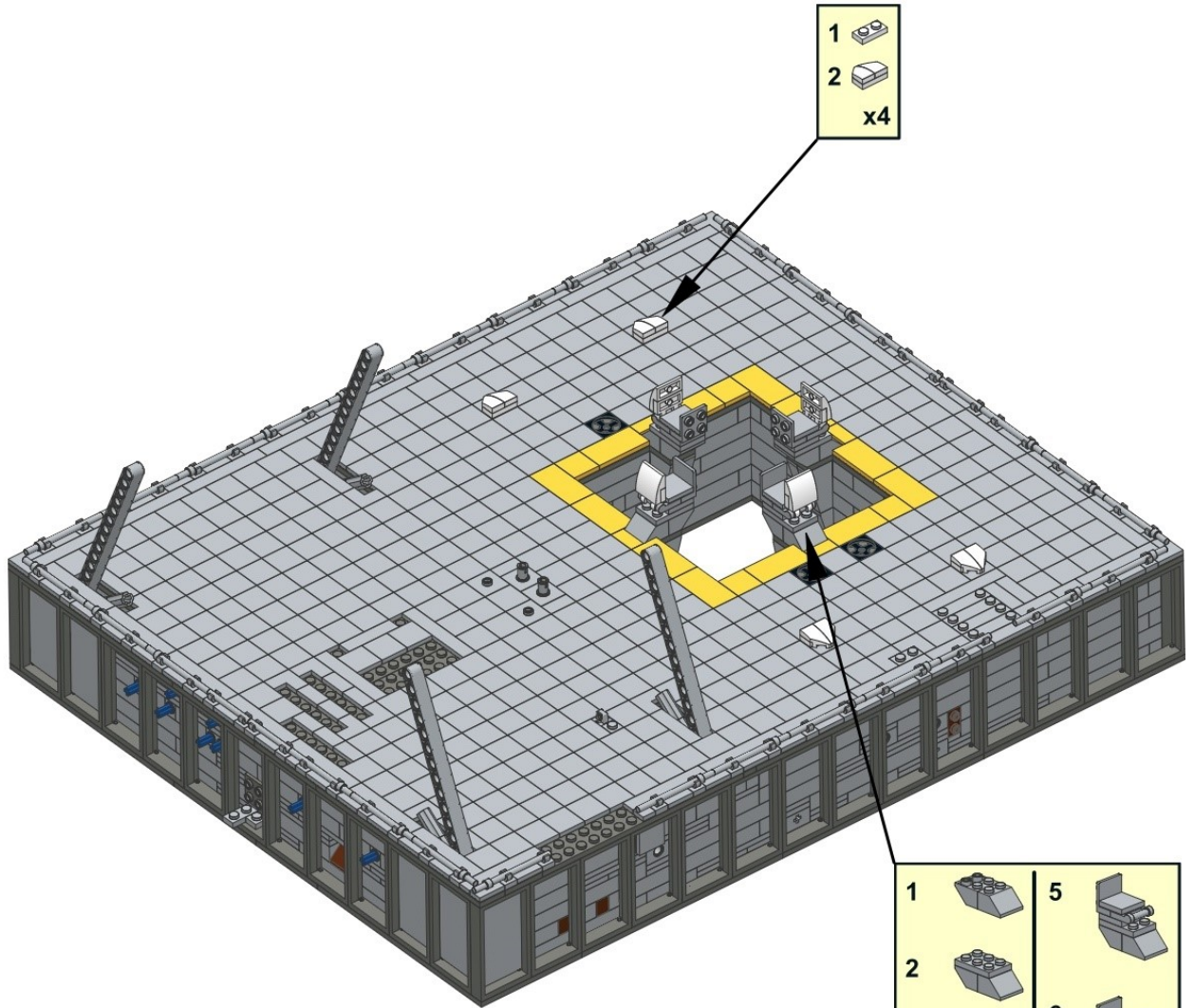
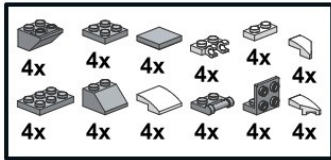





# 116

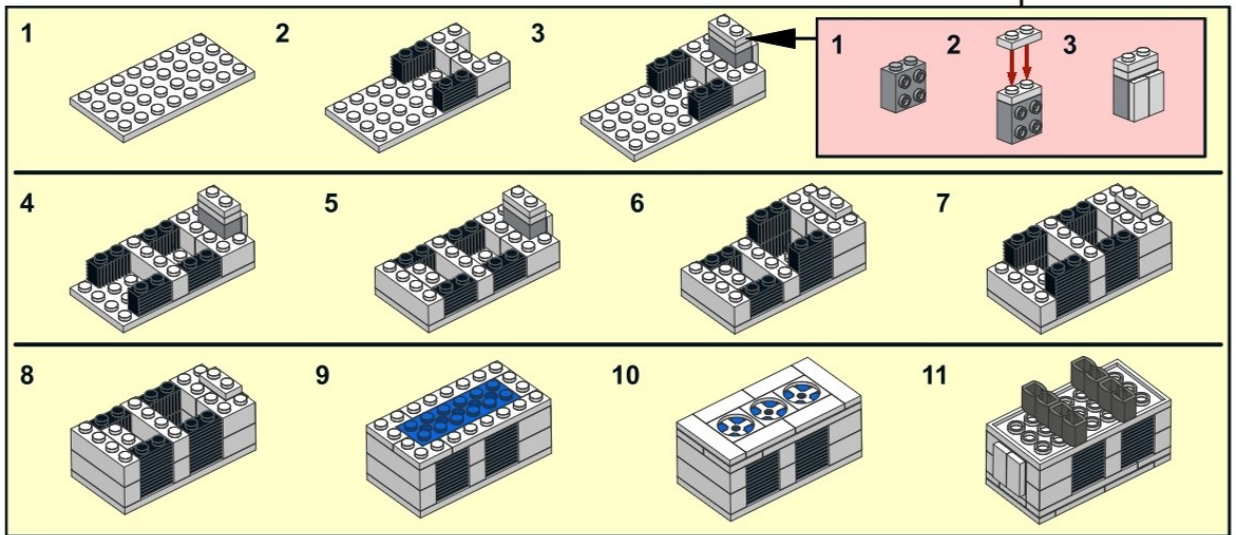
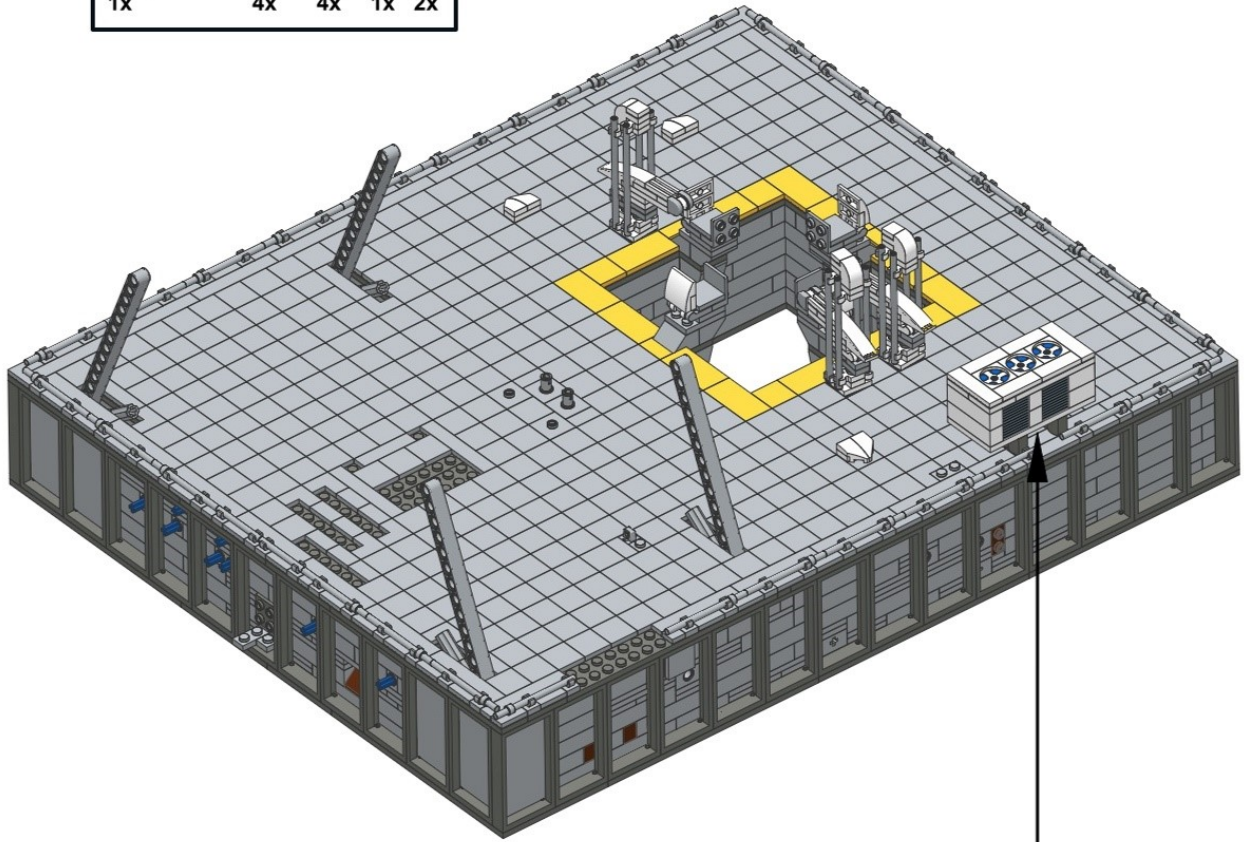
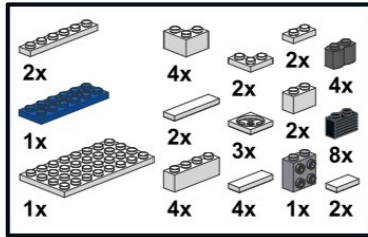



117

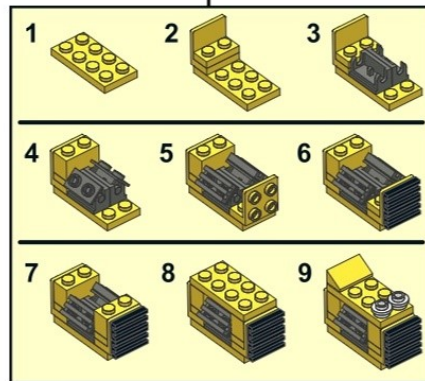
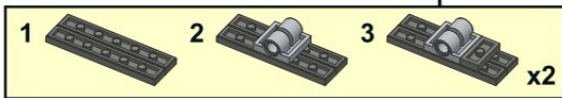
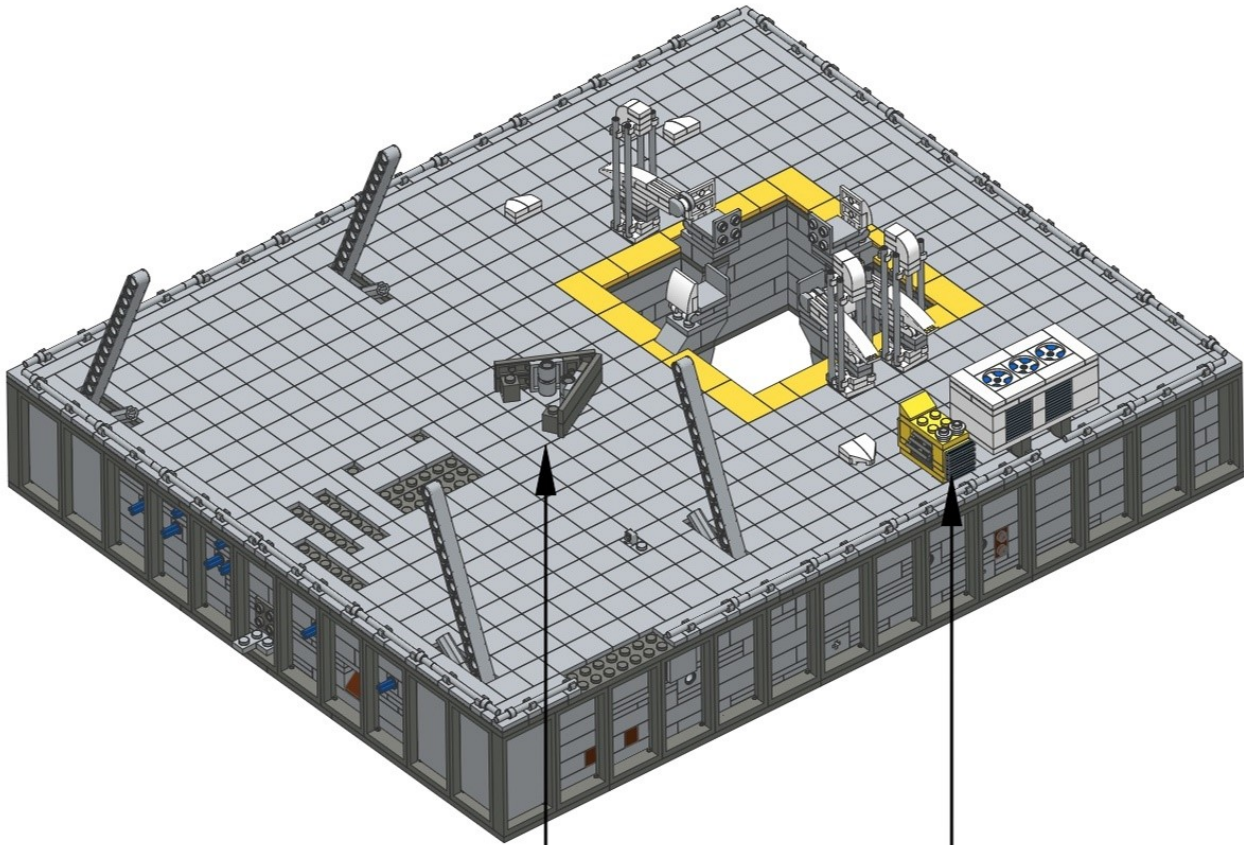
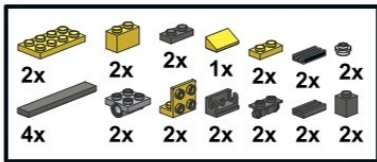

# 118

1x	1x	2x	4x
1x	2x	6x	6x

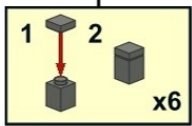
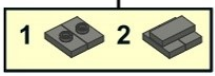
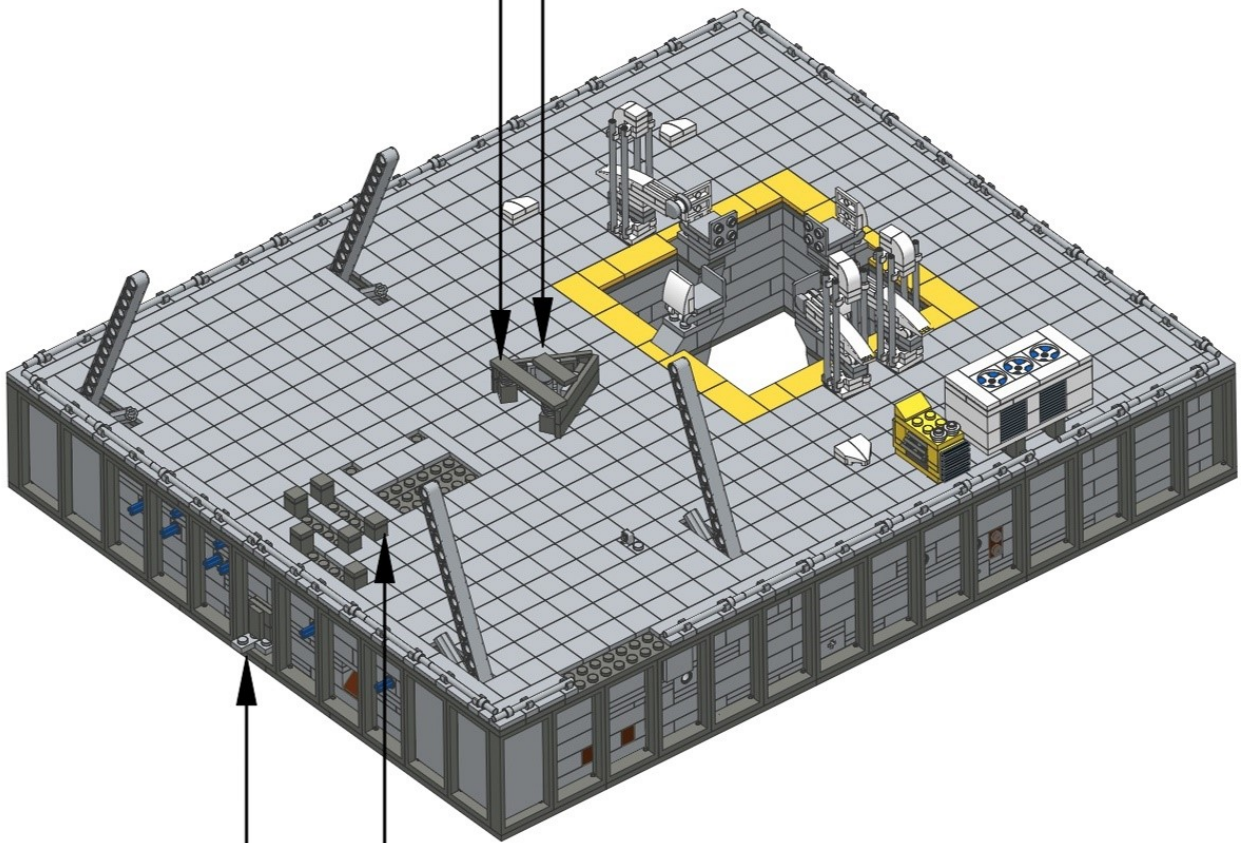
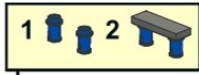
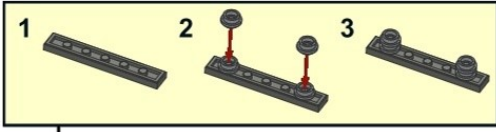



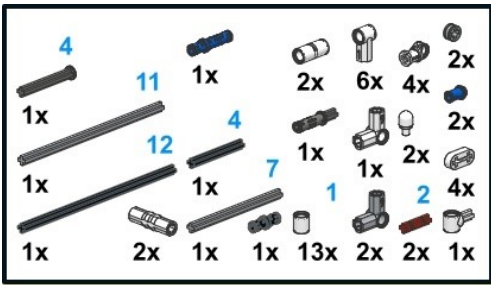

1



2



3



4

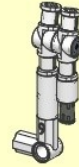

5

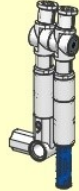

6

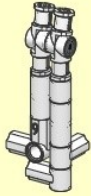

7

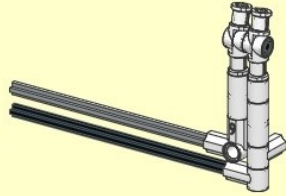

8

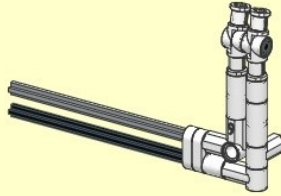

9

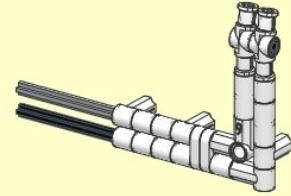

10

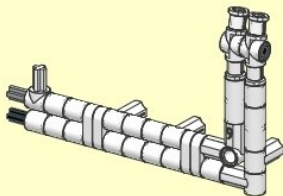

11

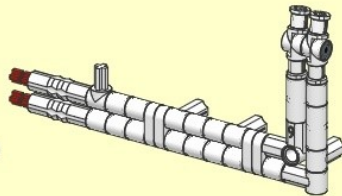

12

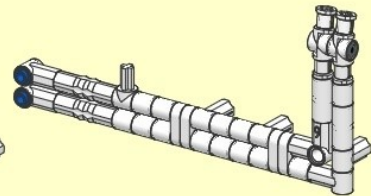

13

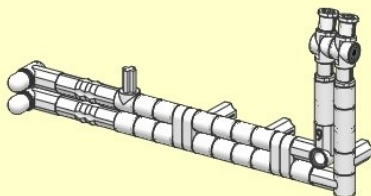

14

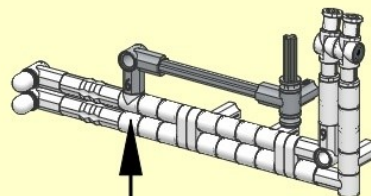

# 119

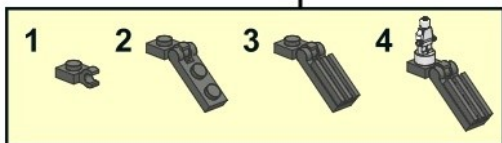
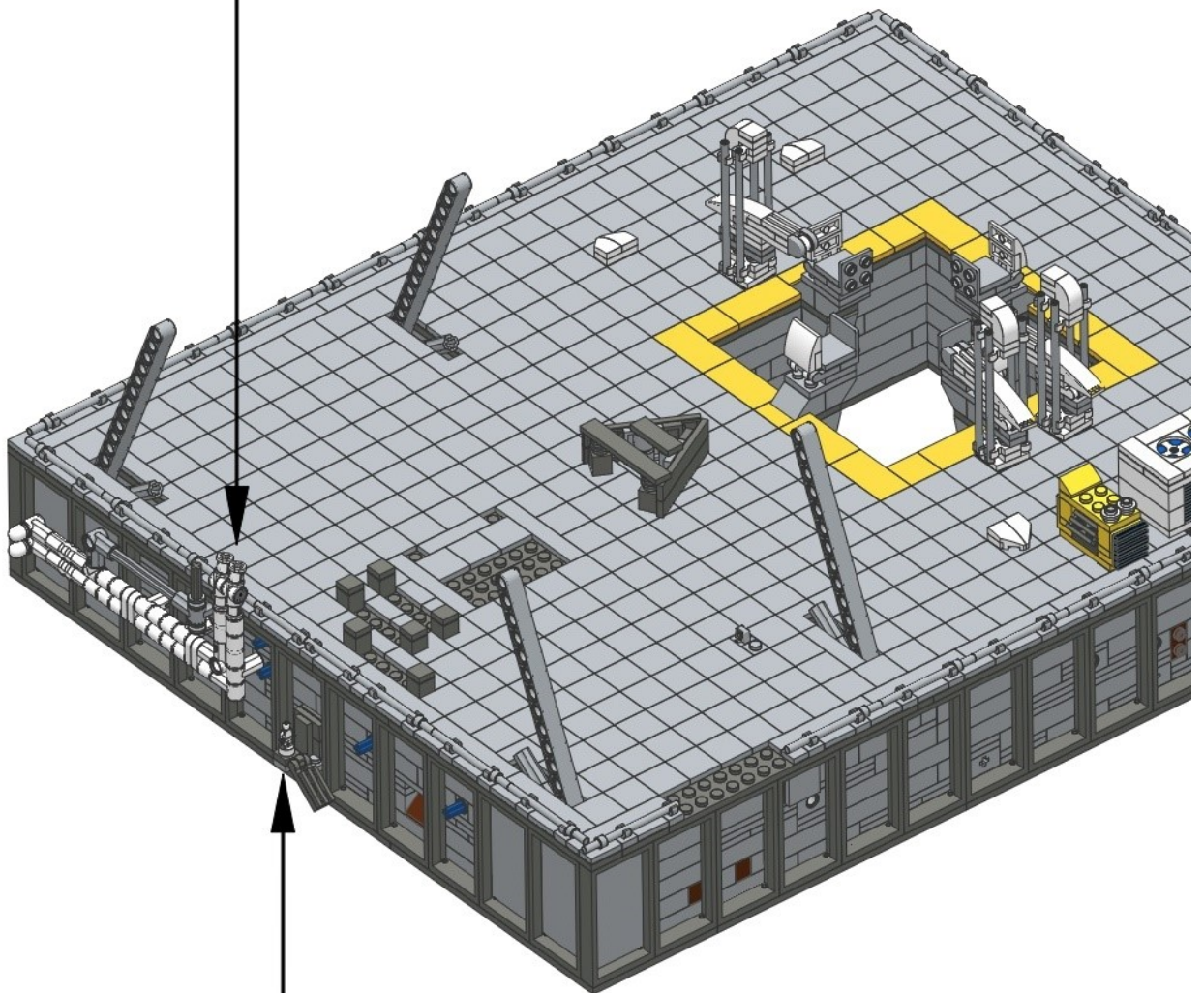
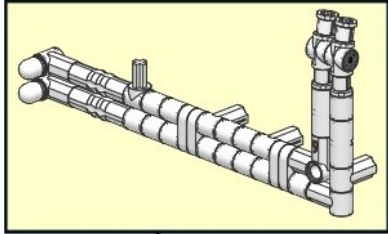
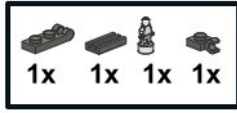



# 120

- |    |    |    |    |    |    |    |    |
|----|----|----|----|----|----|----|----|
| 3  | 11 | 1x | 5  | 4x | 5x | 1x | 2x |
| 1x | 1x | 1x | 1x | 1x | 1x | 2x | 2x |
| 4x | 2x | 1x | 1x | 1x | 1x | 2x | 2x |

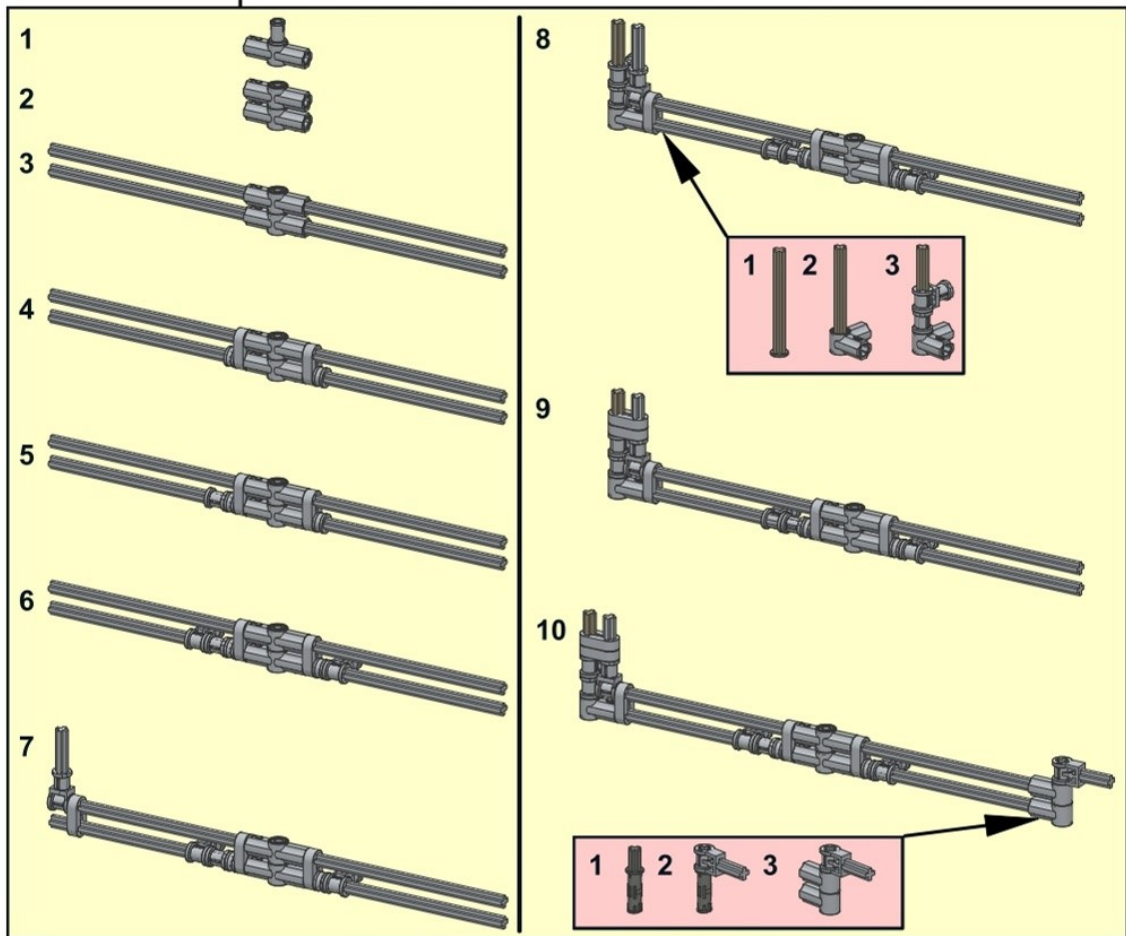
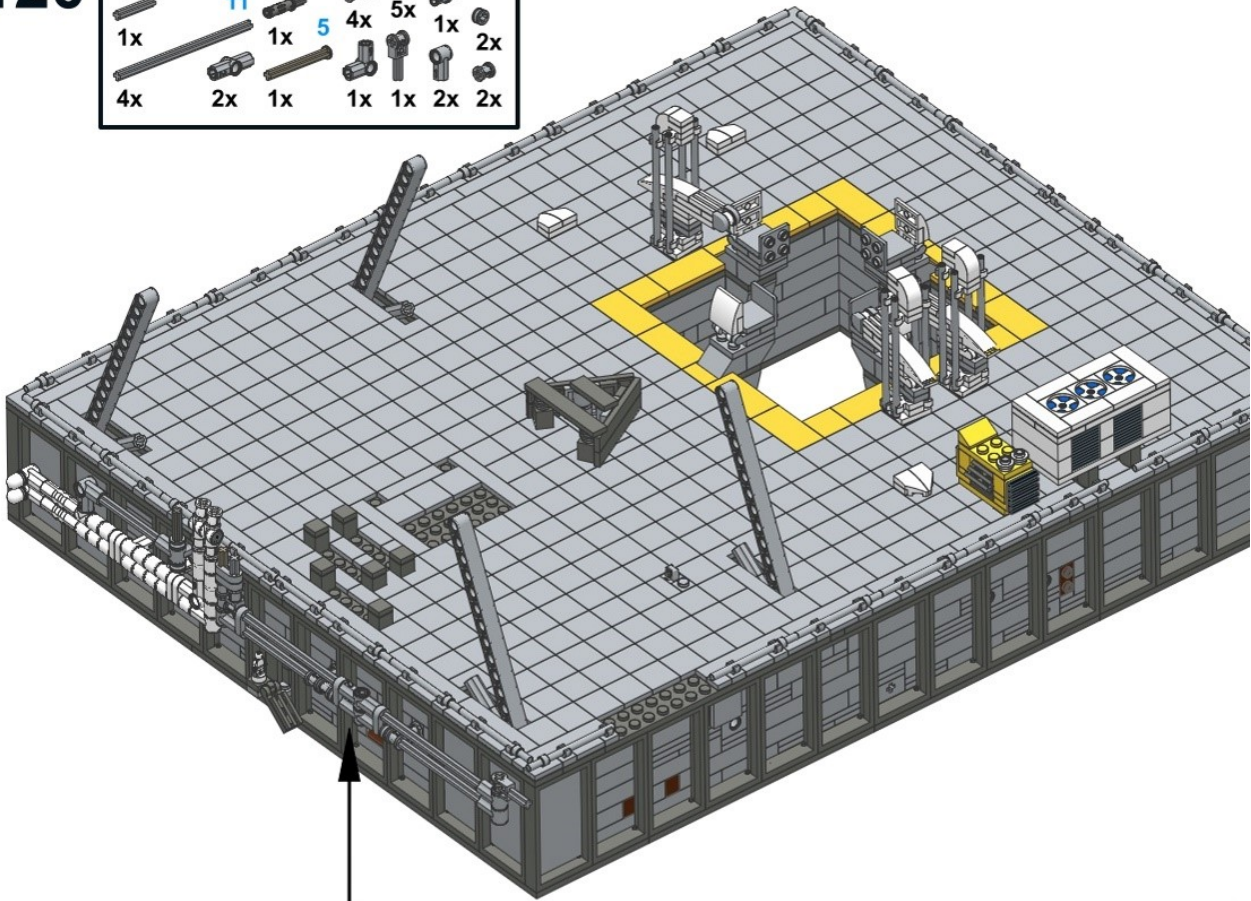

# 121

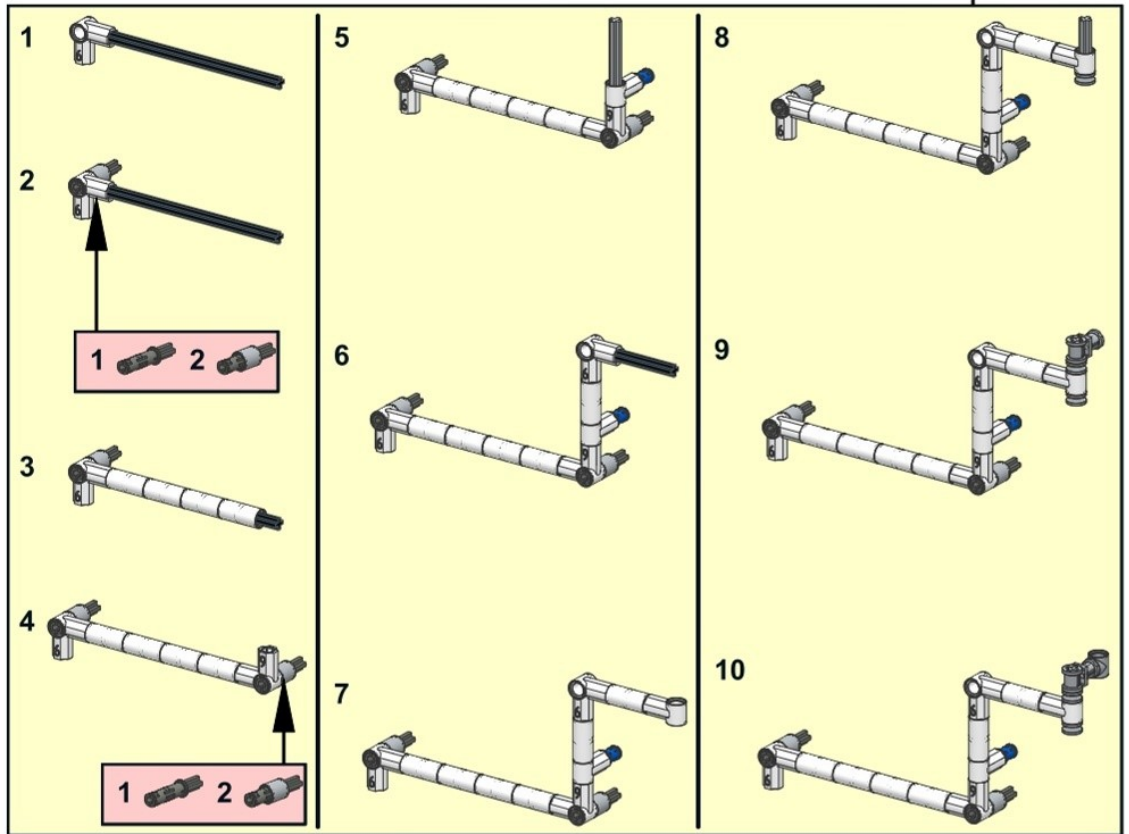
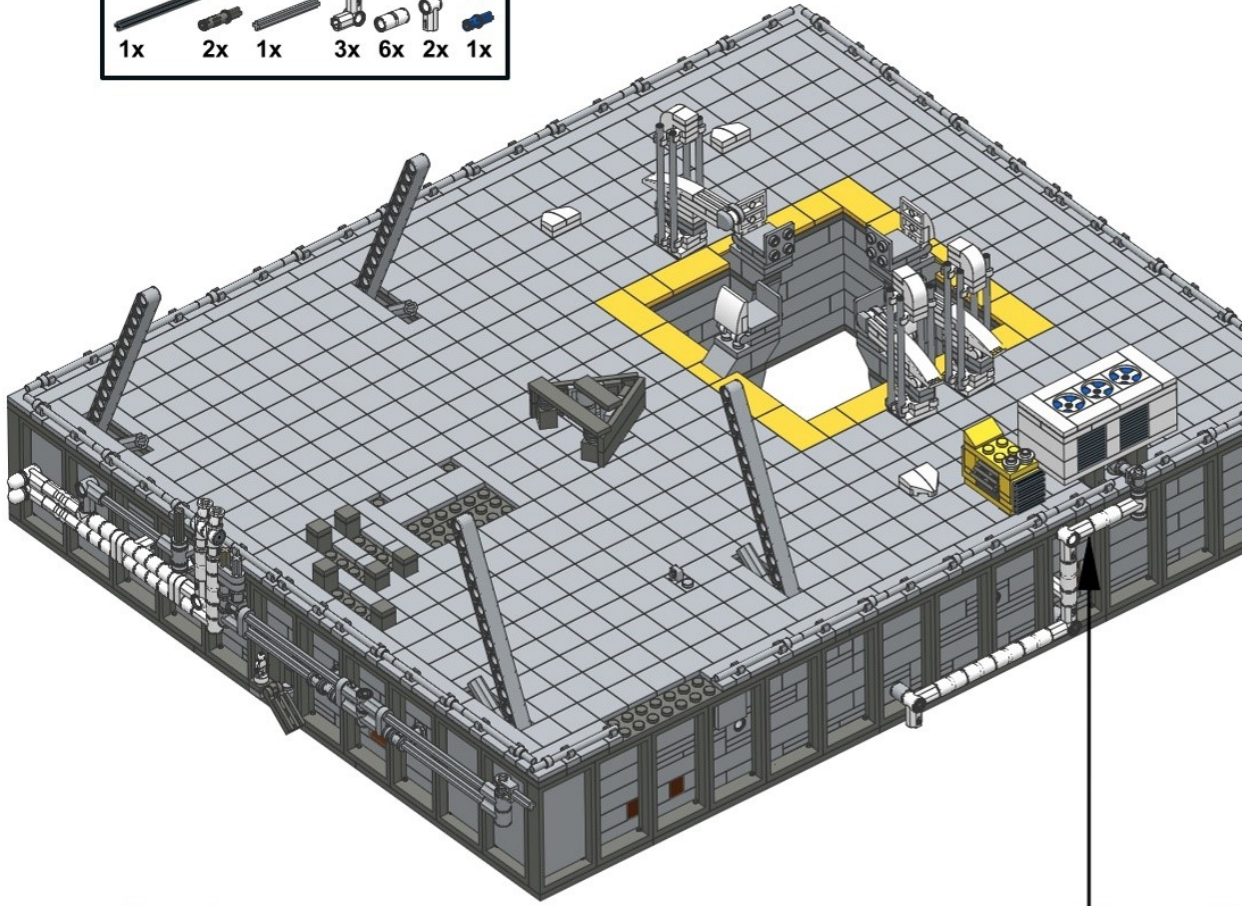
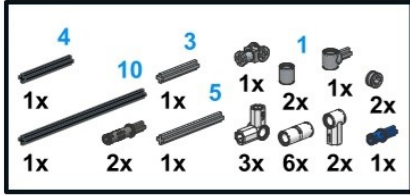



# 122

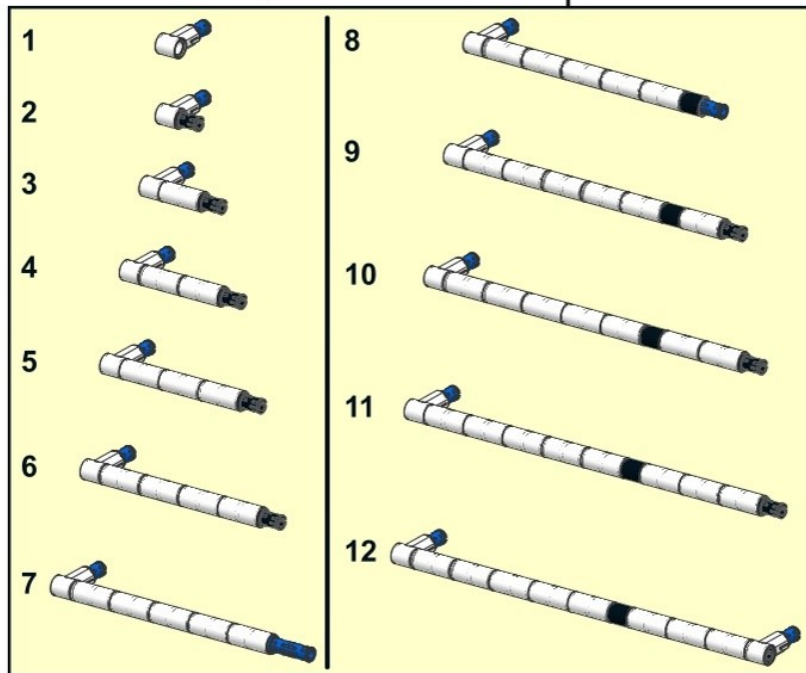
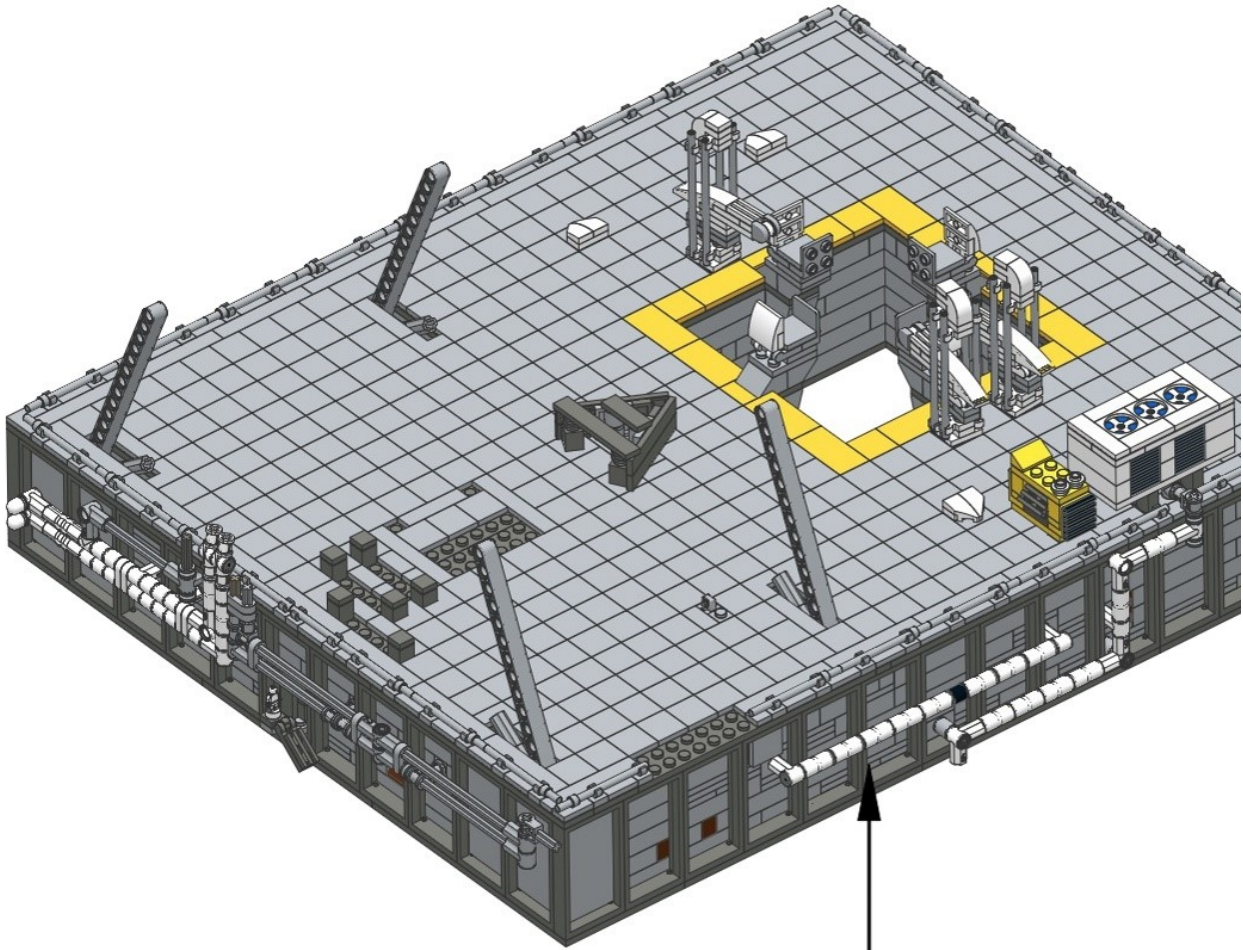

123

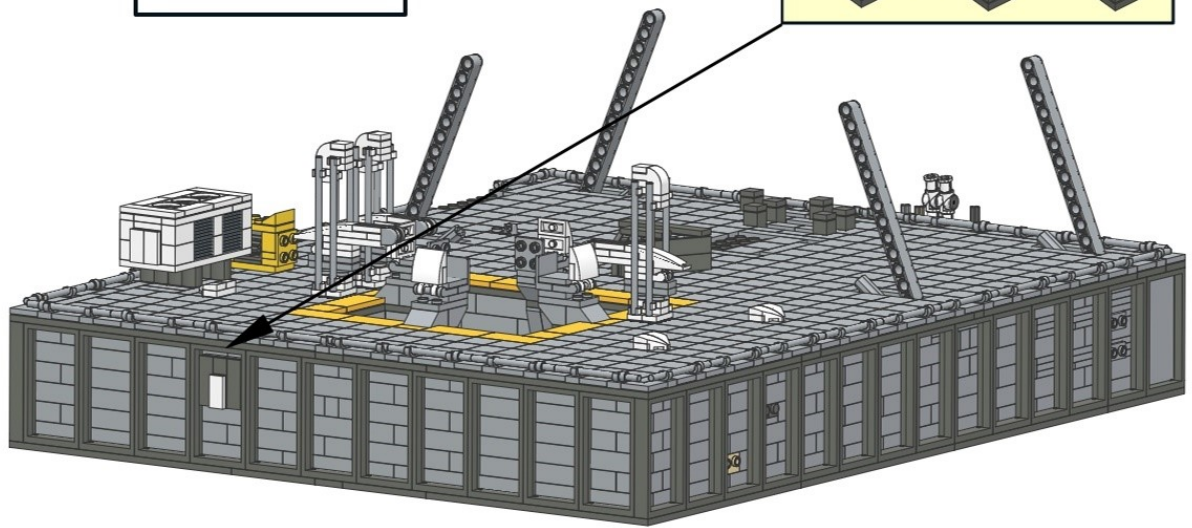
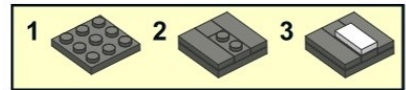
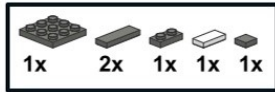

124

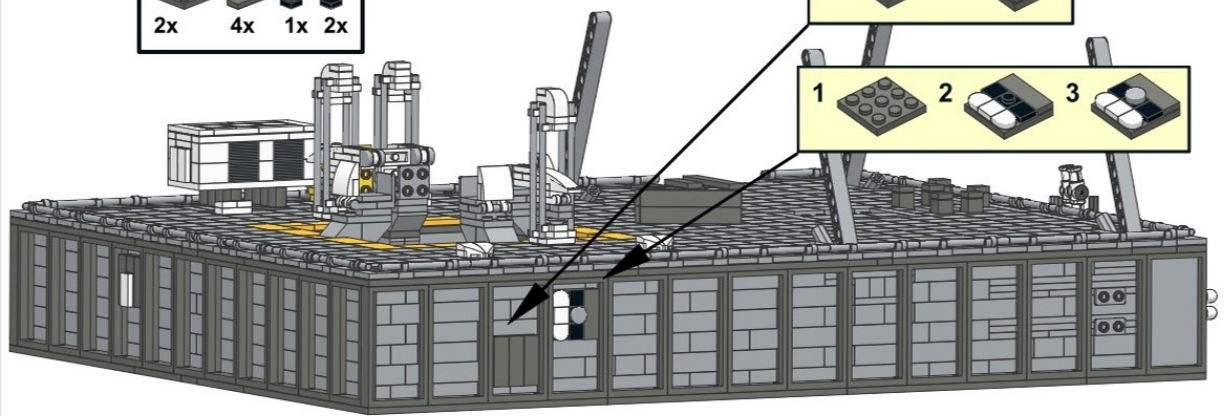
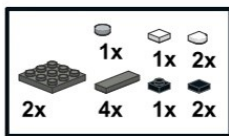

125

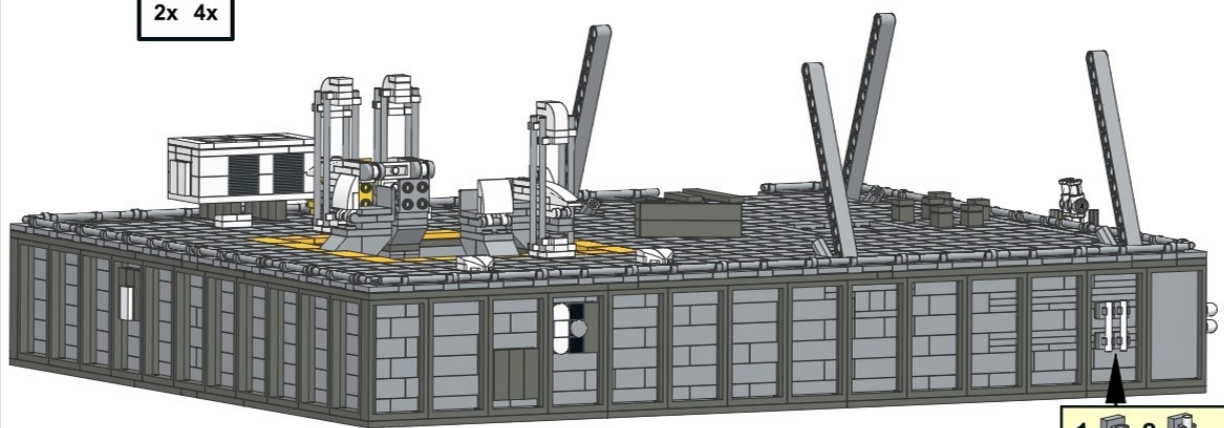
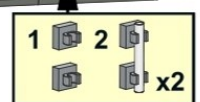
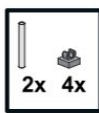



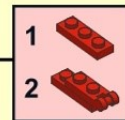
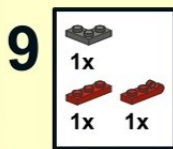
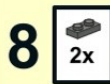
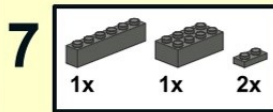
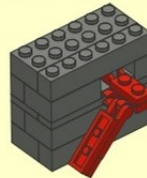
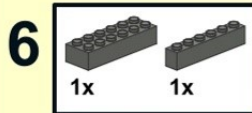
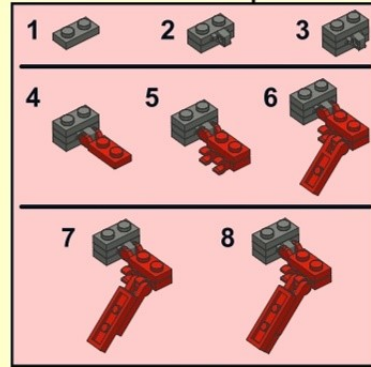
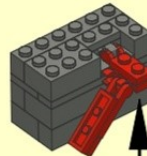
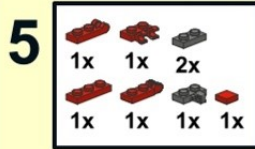
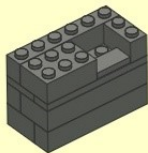
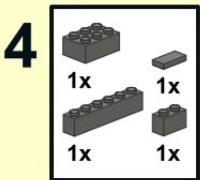
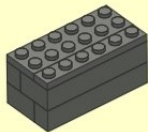
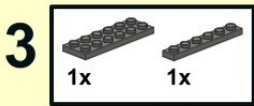
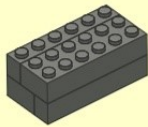
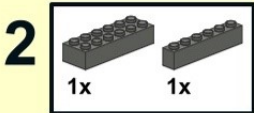
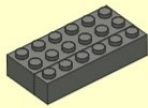
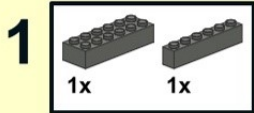

10

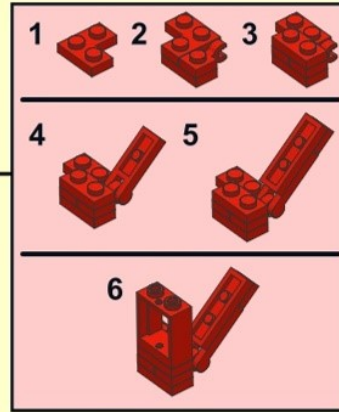
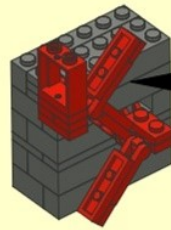
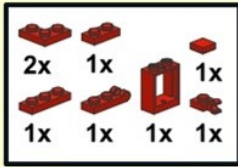

11

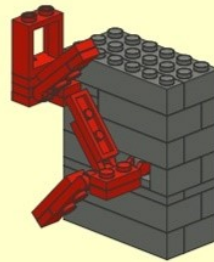
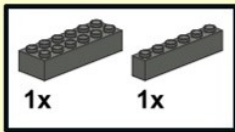

12

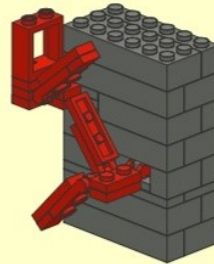
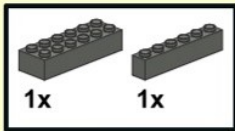

13

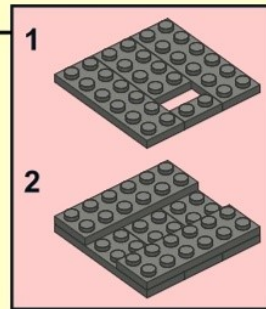
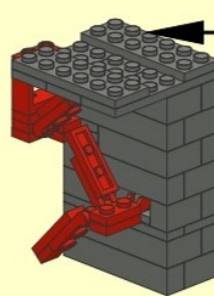
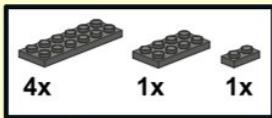

14

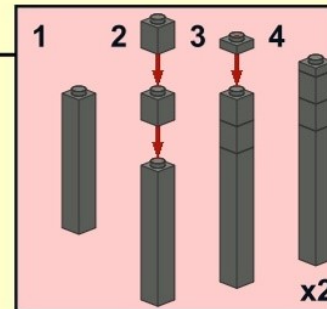
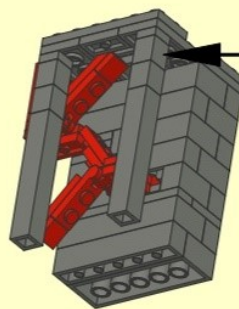
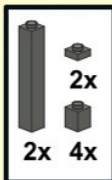



126

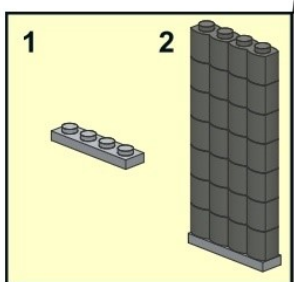
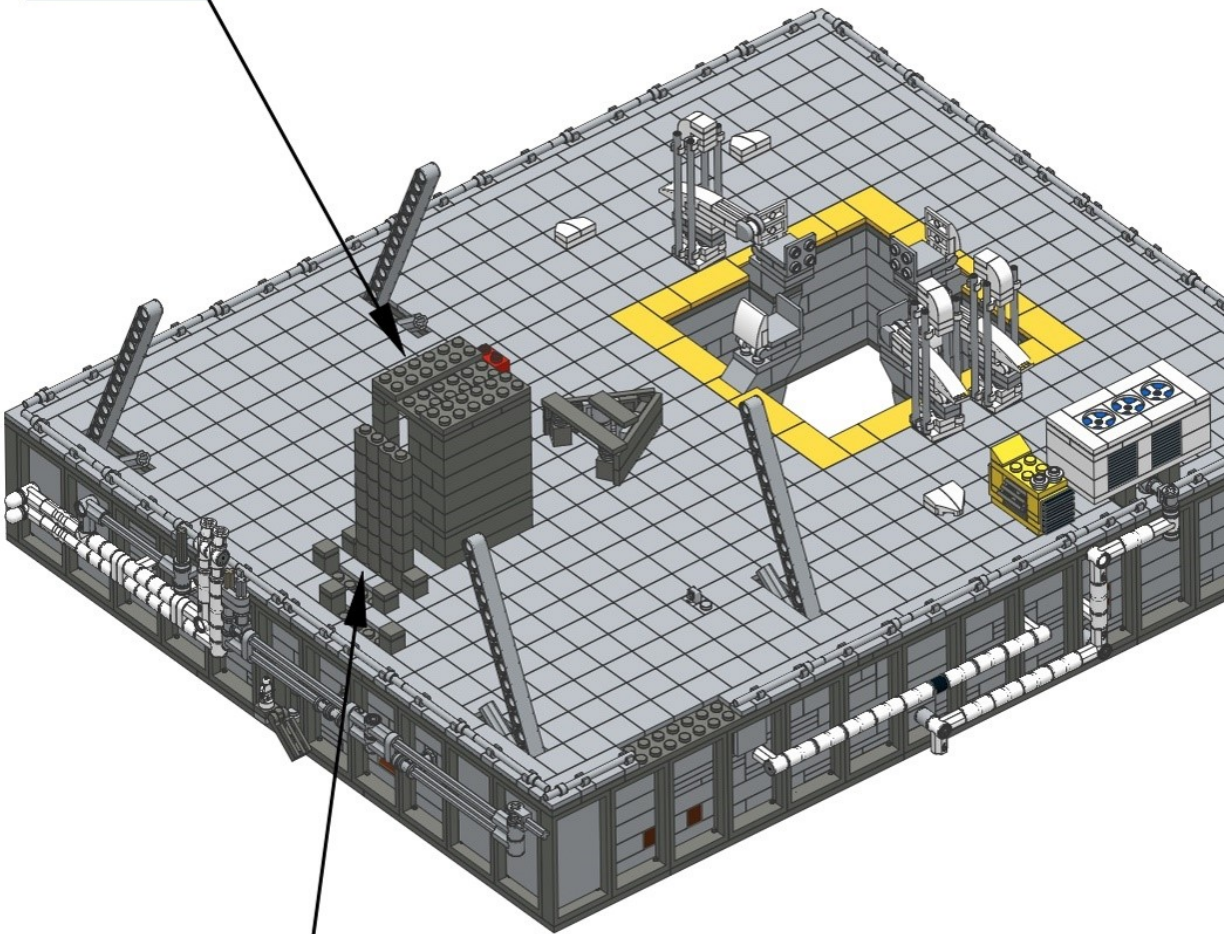
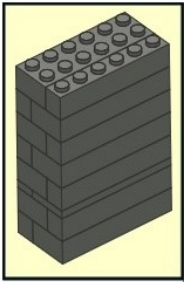
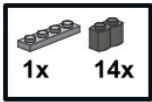

# 127

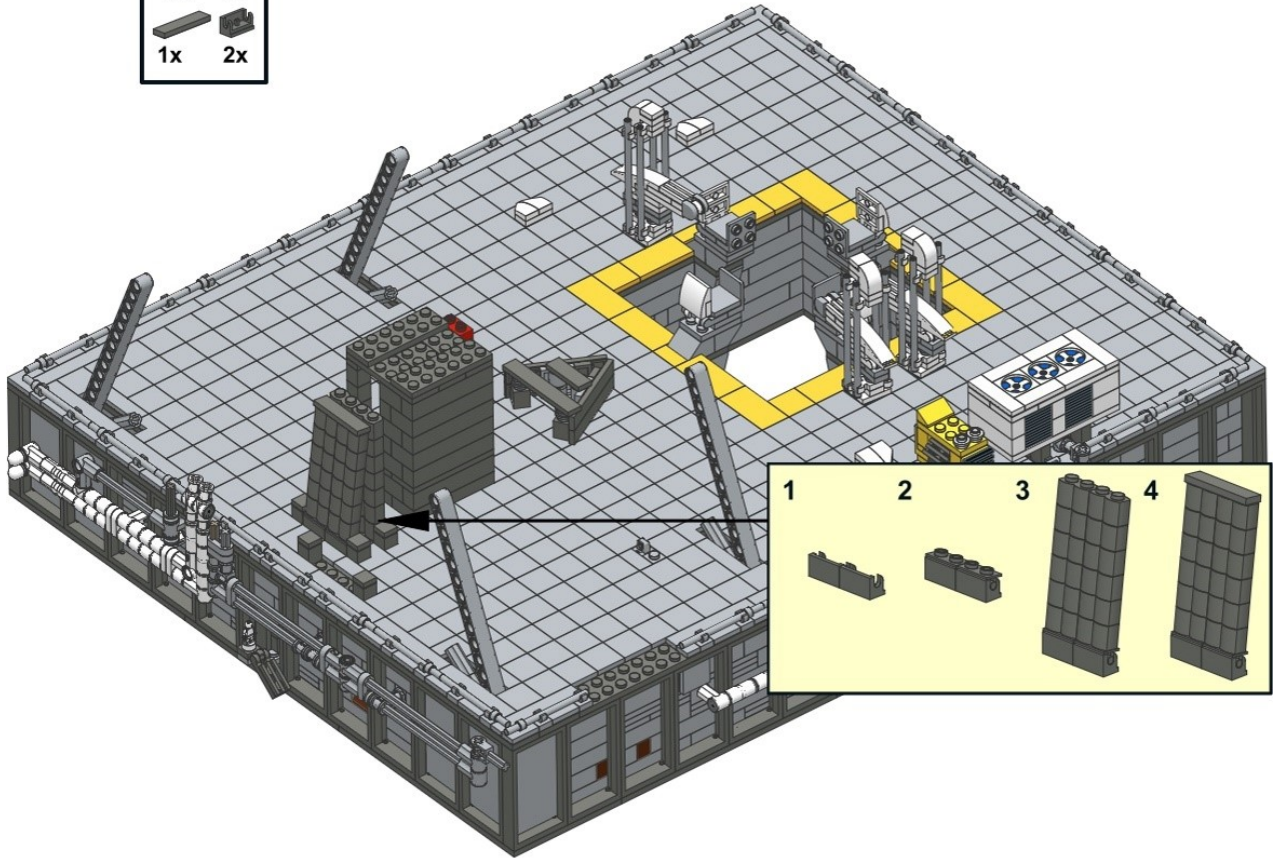

# 128

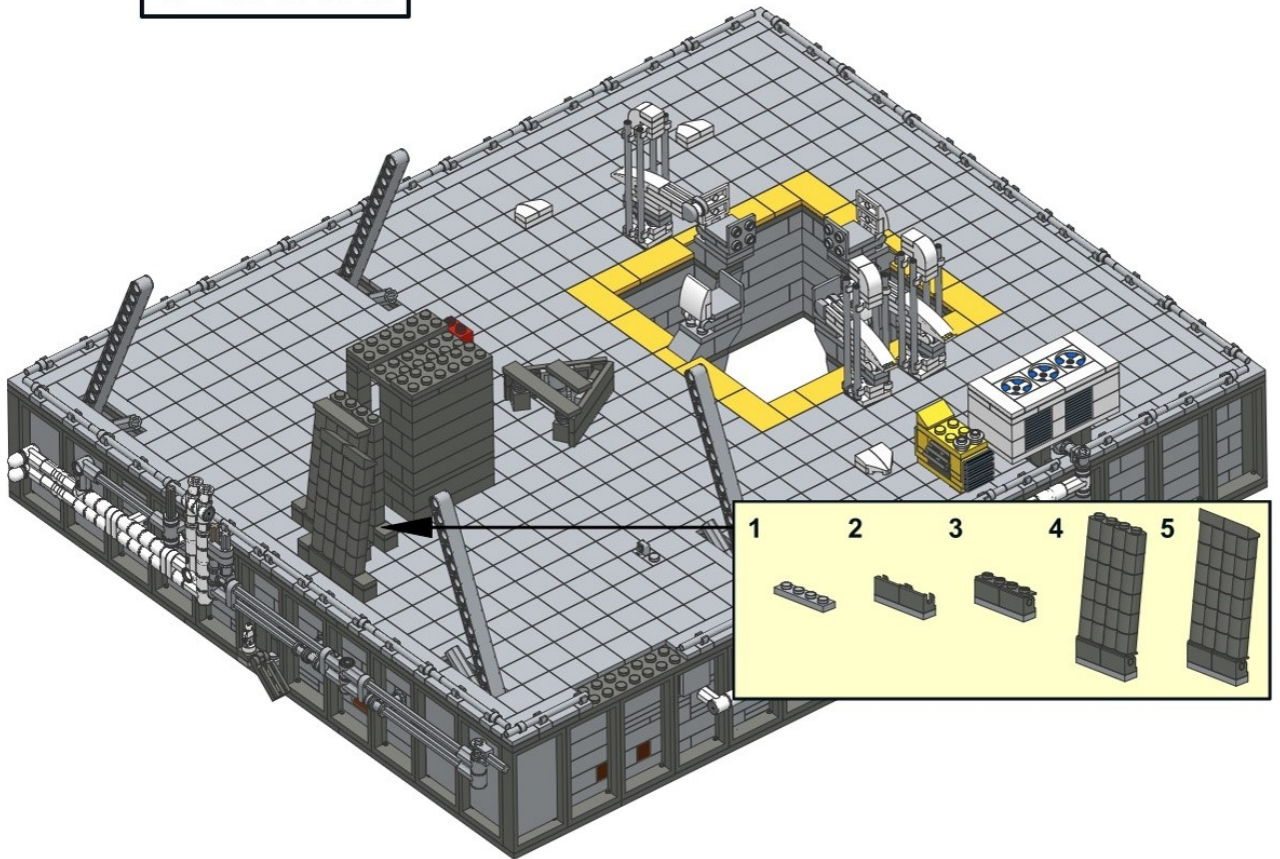



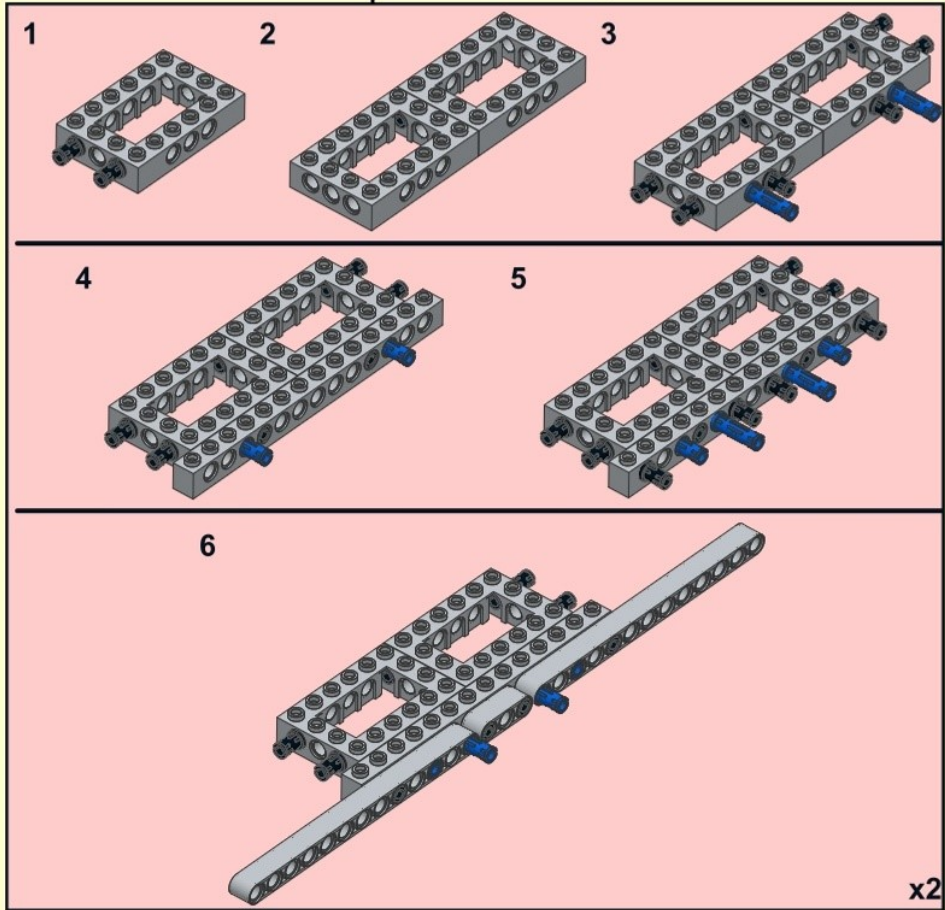
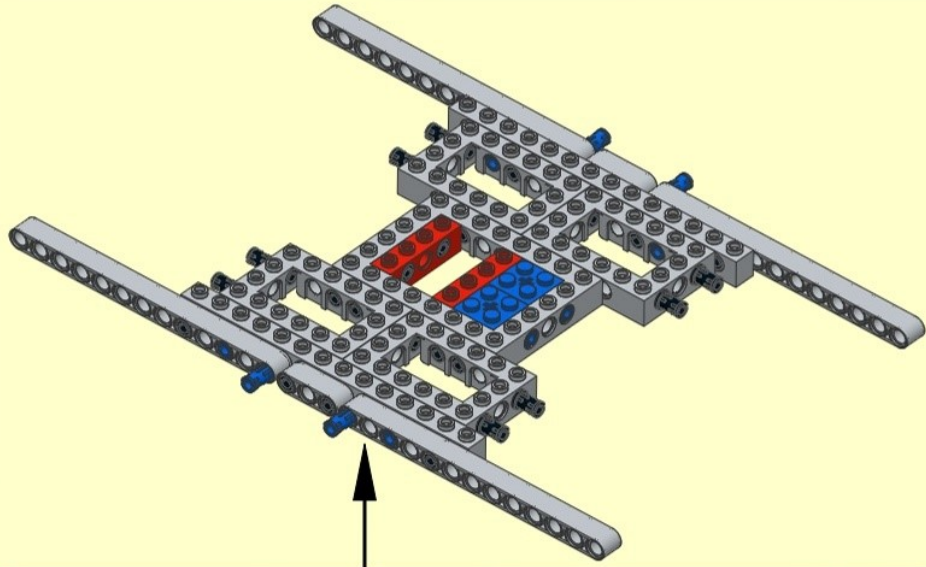
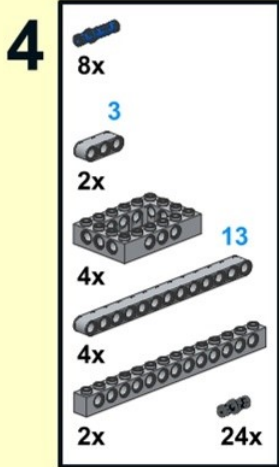
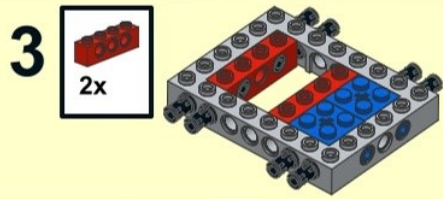
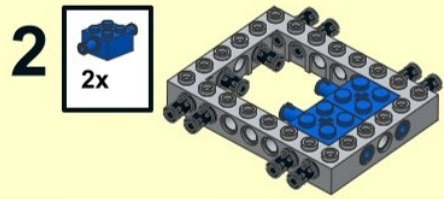
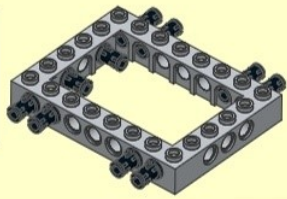
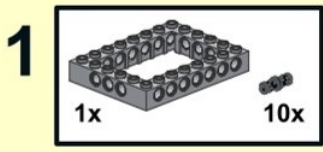

5

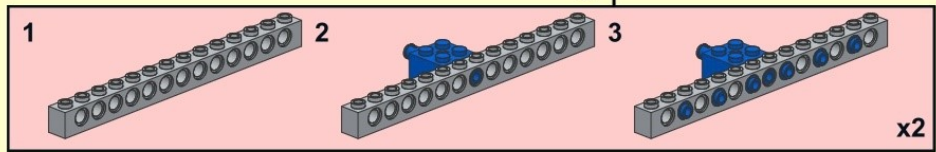
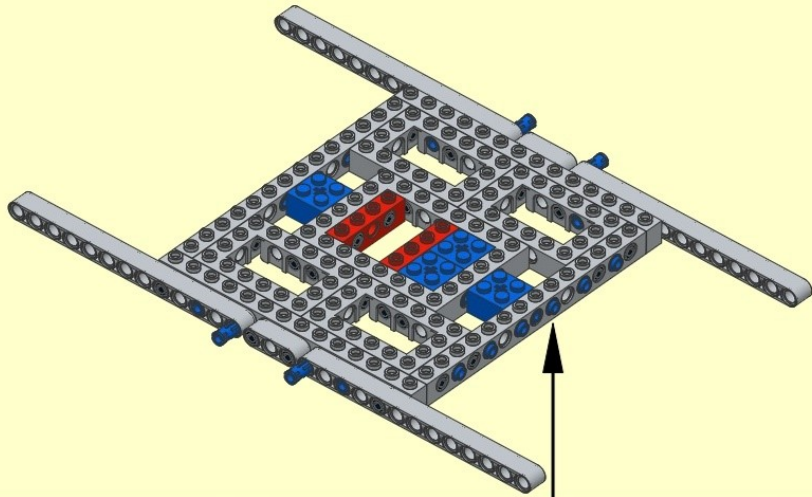
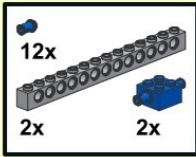

6

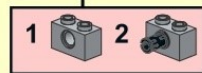
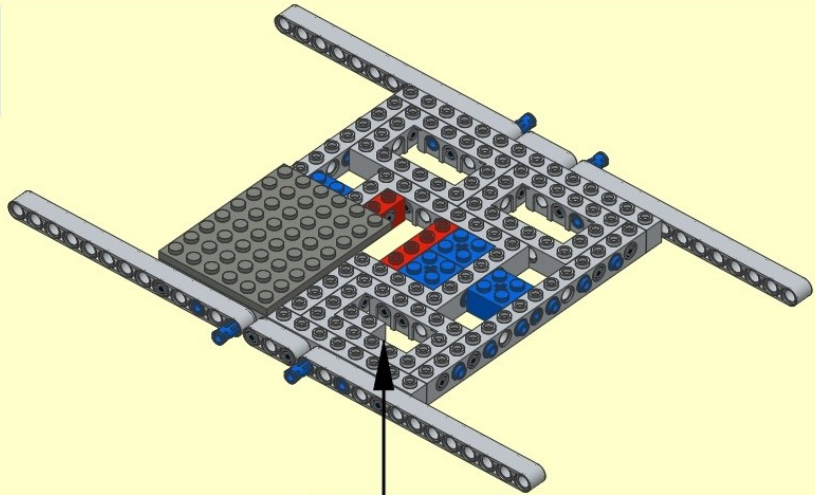
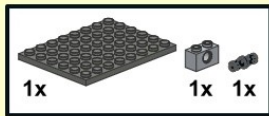

7

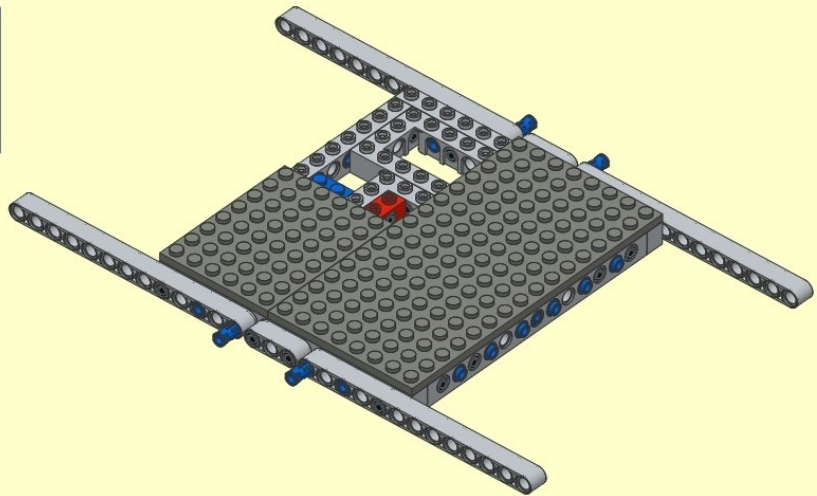
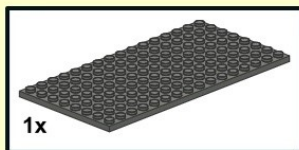



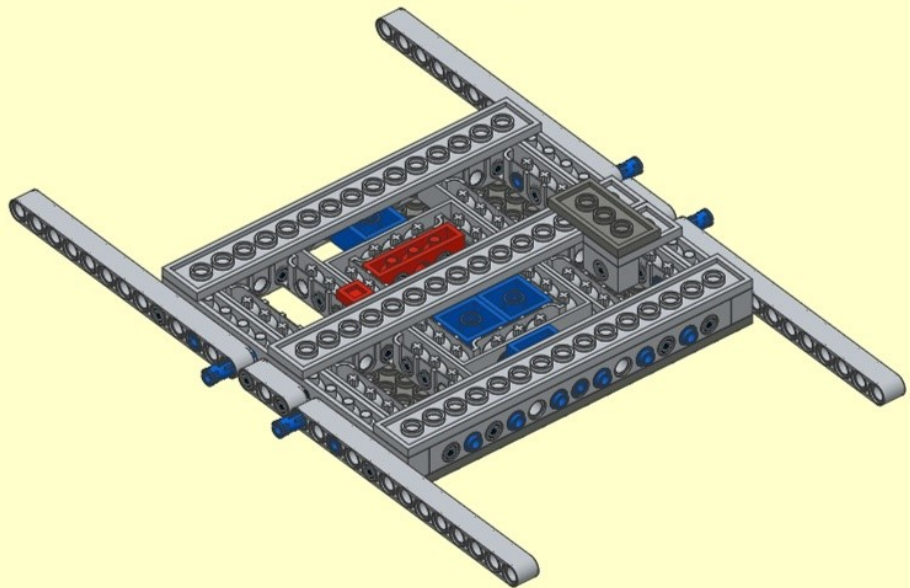
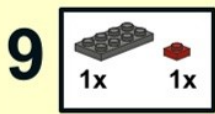
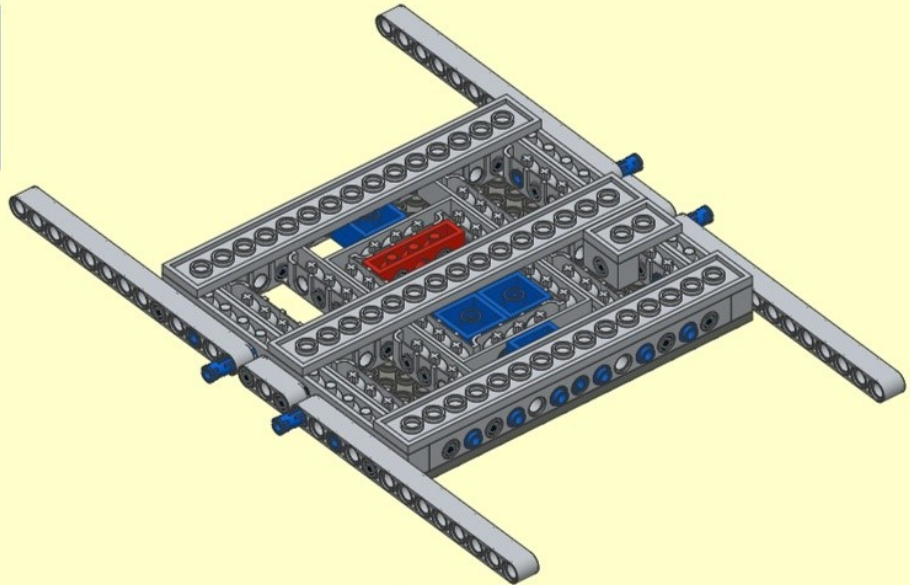
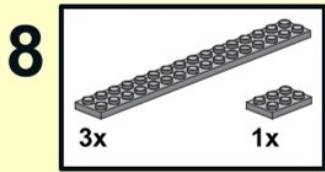

**129**

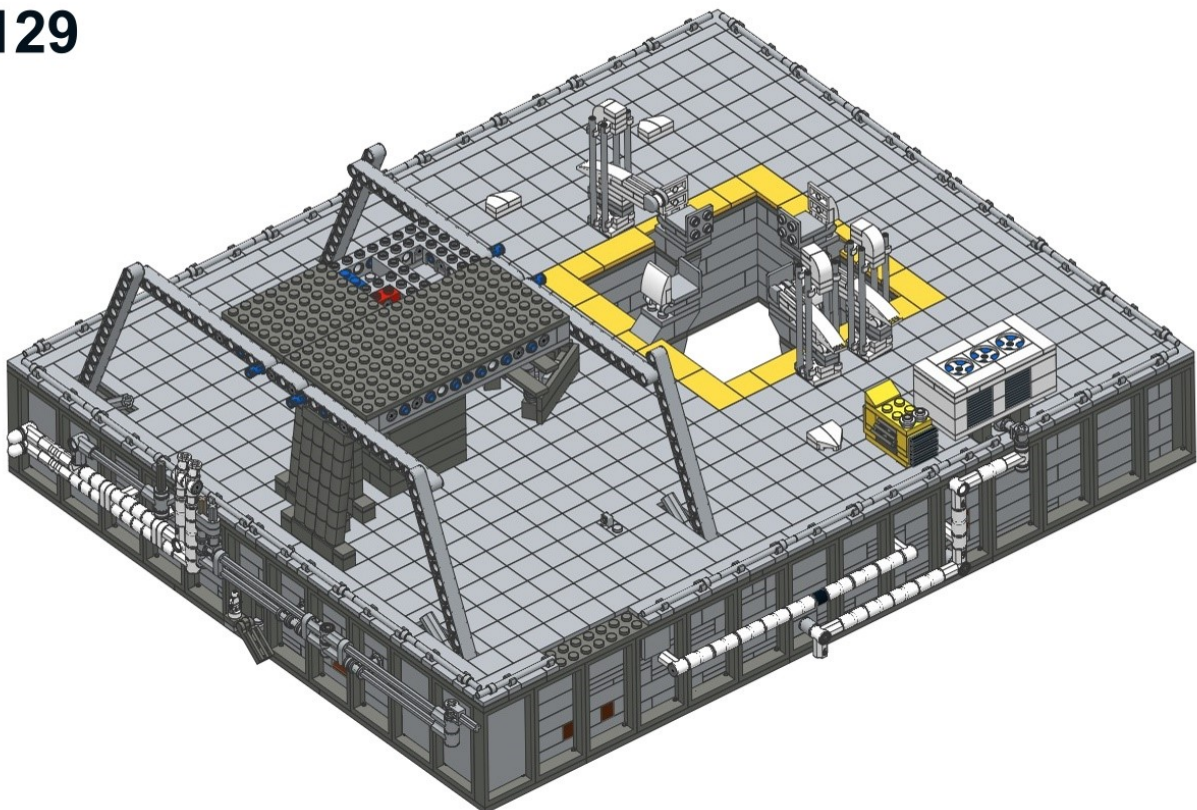

# 130

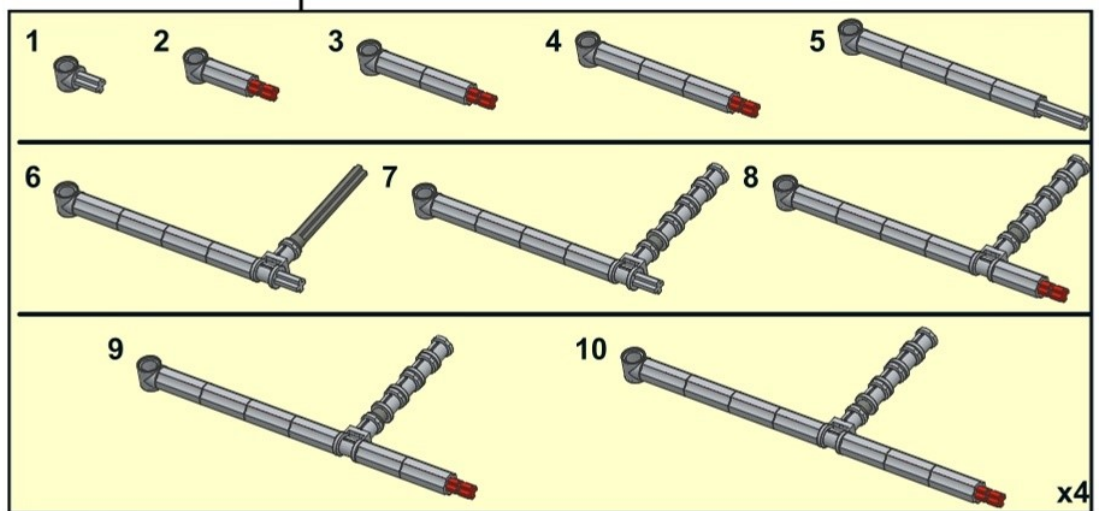
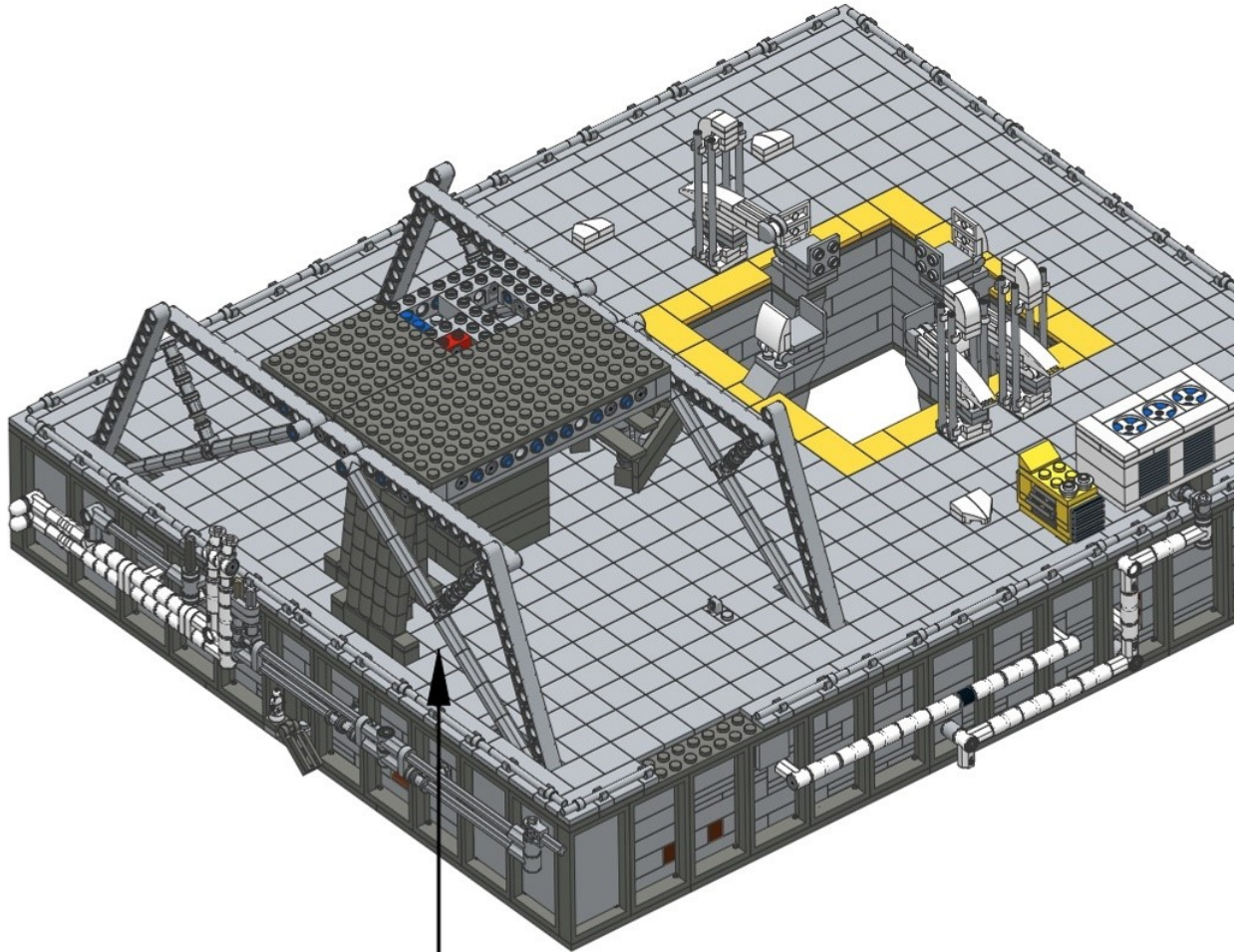
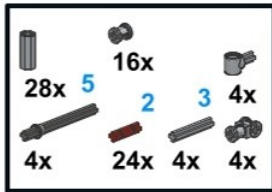



# 131

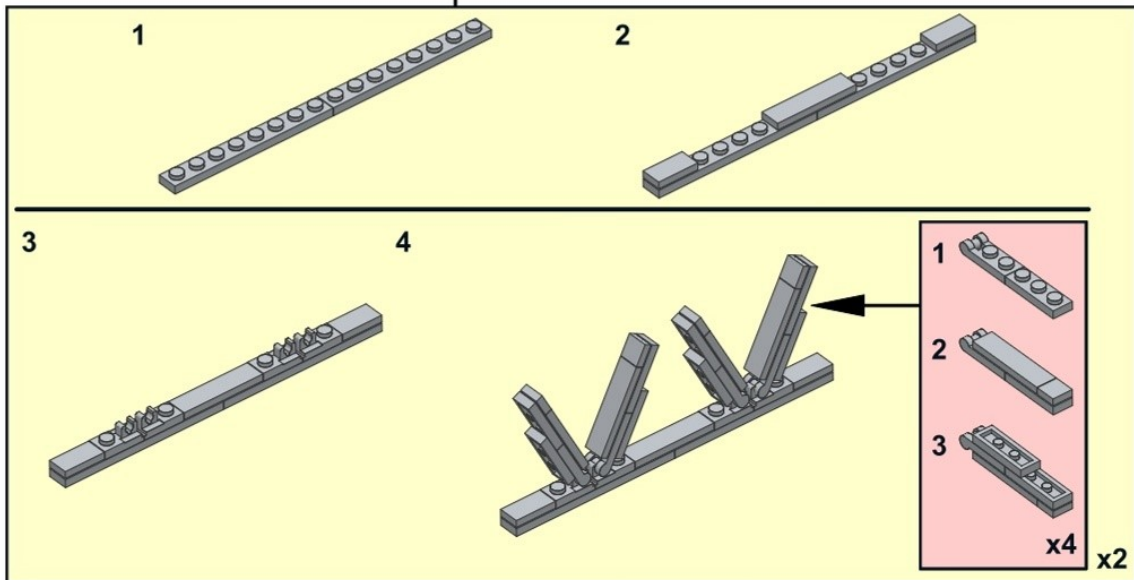
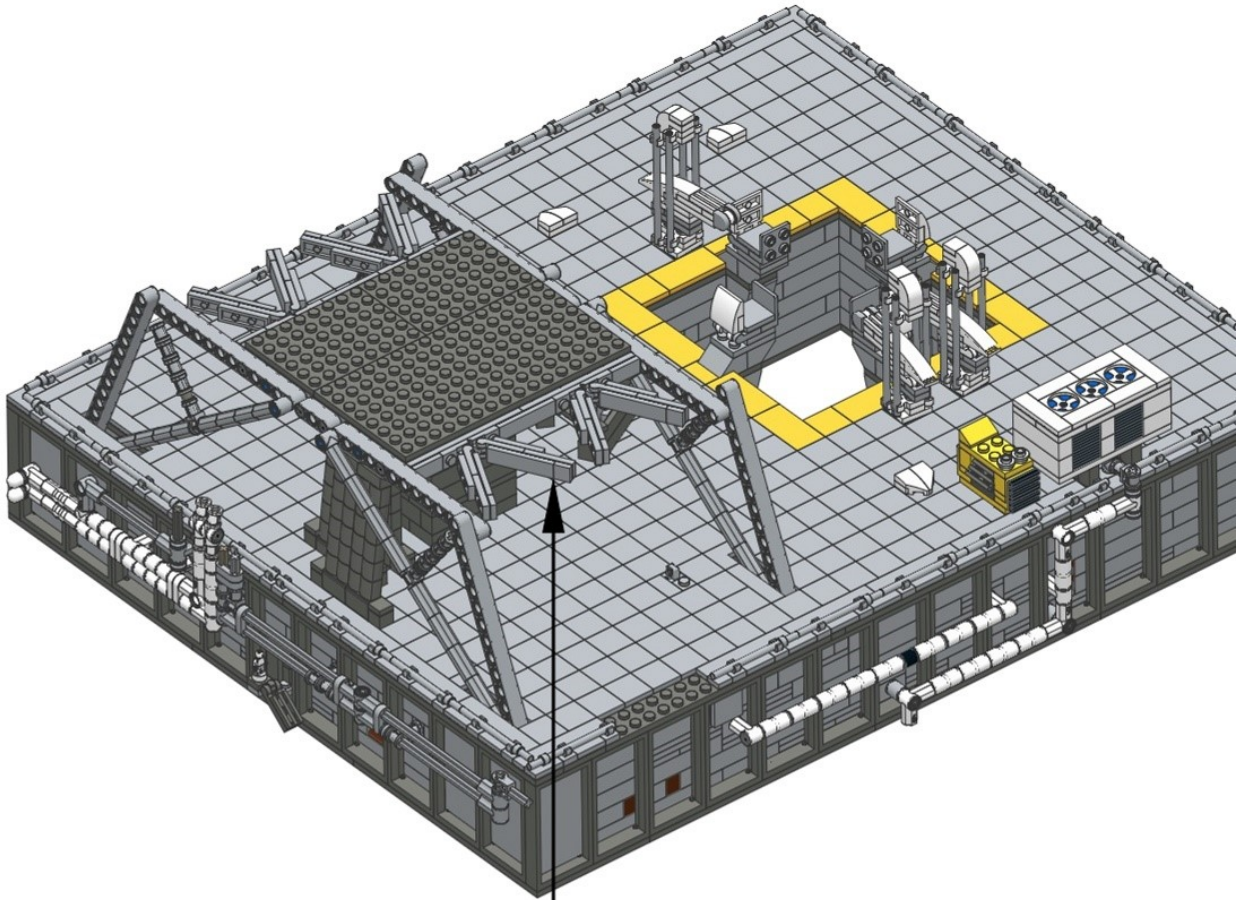
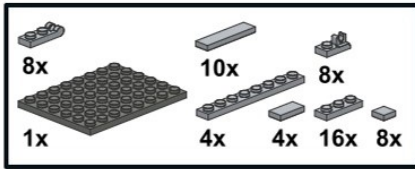

# 132

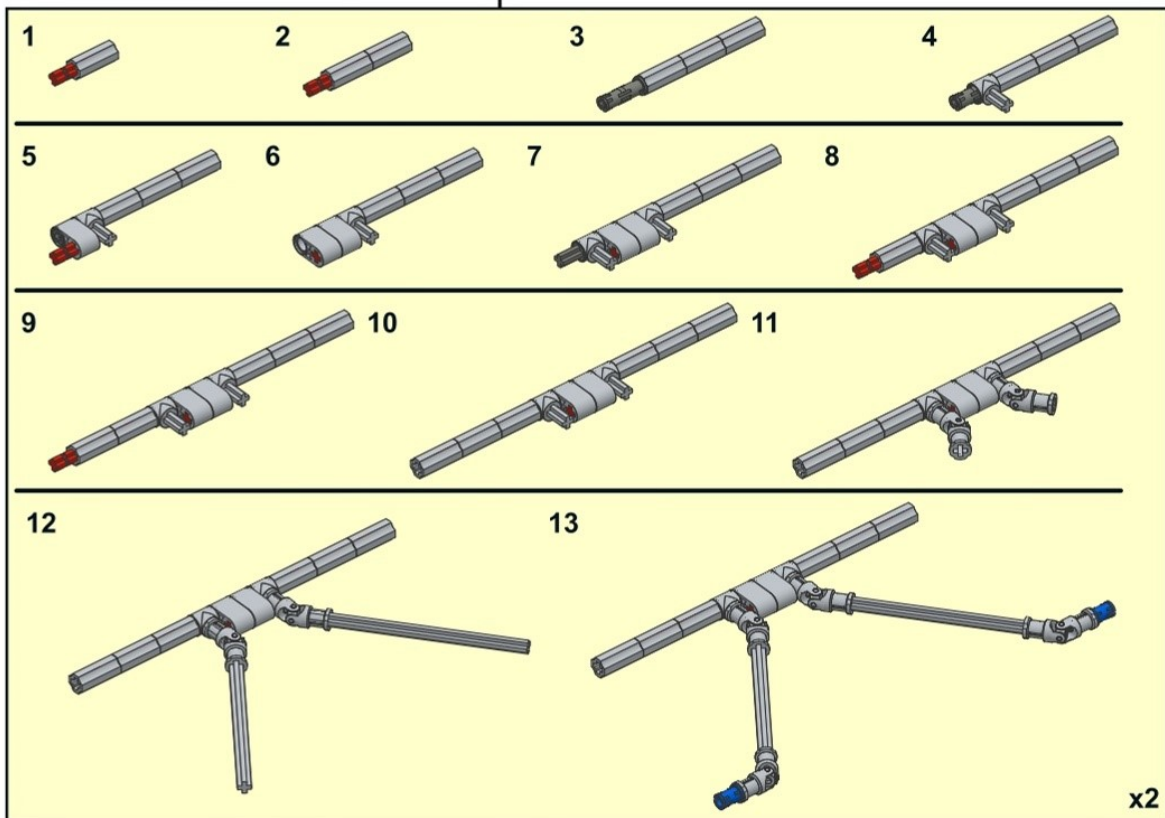
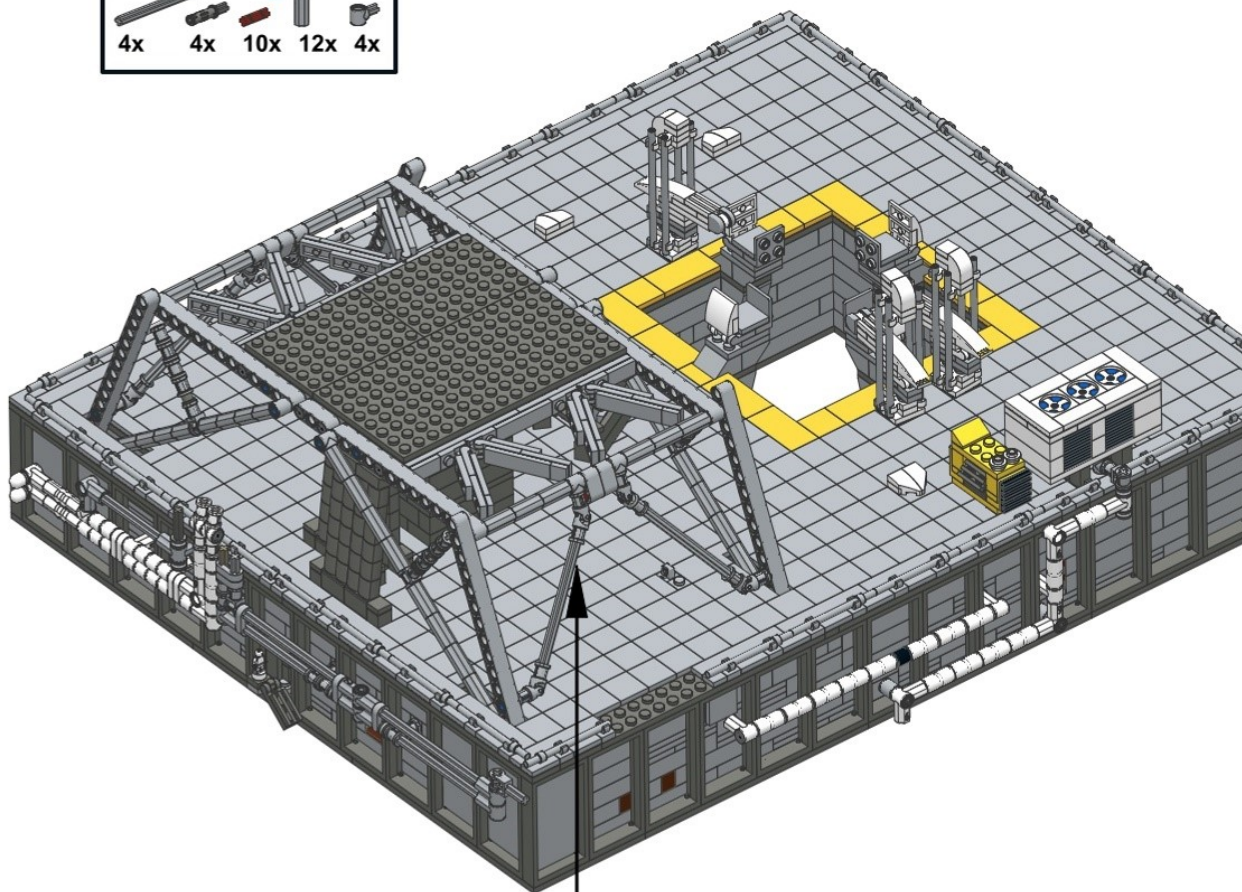
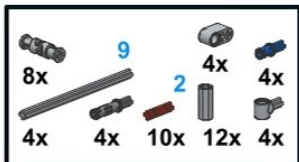



133

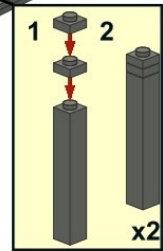
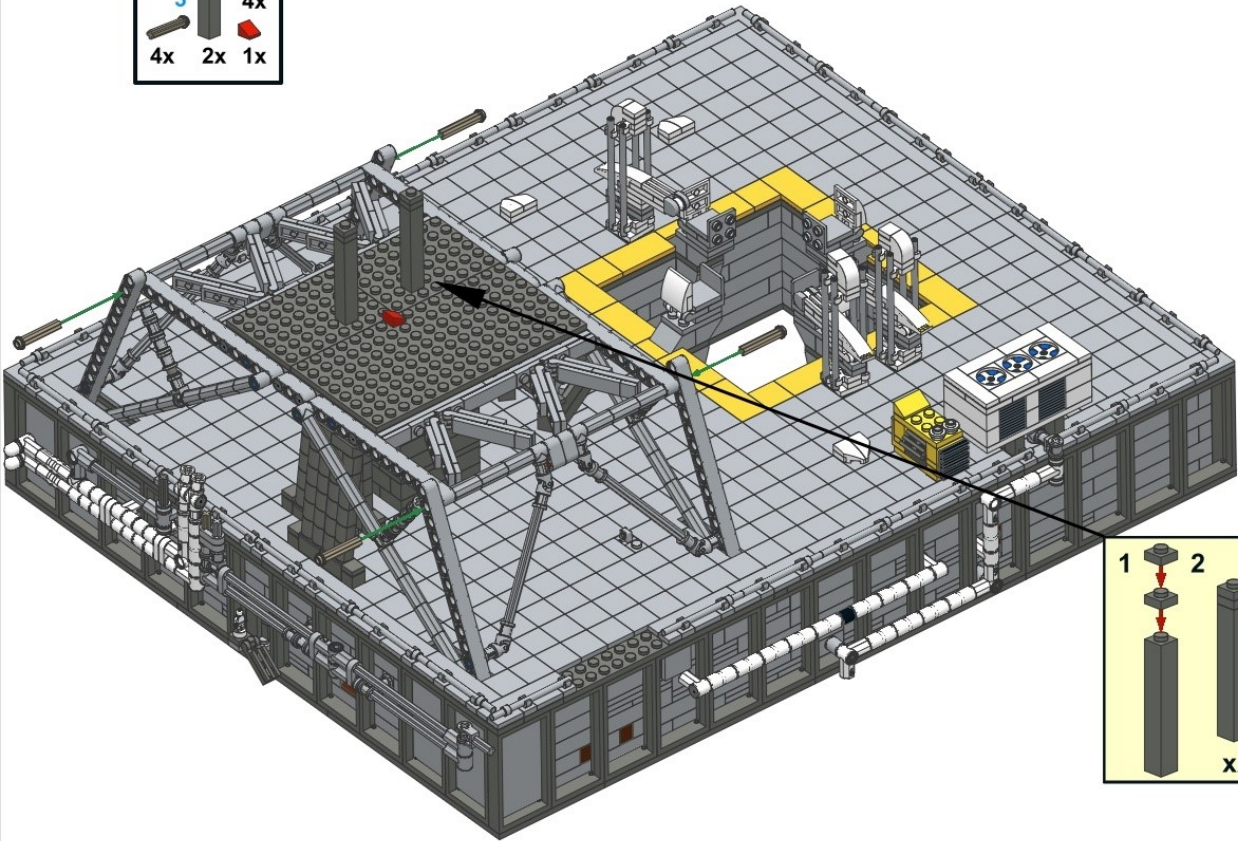
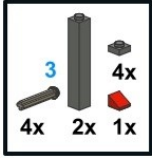

134

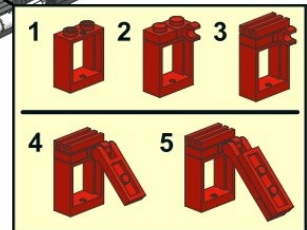
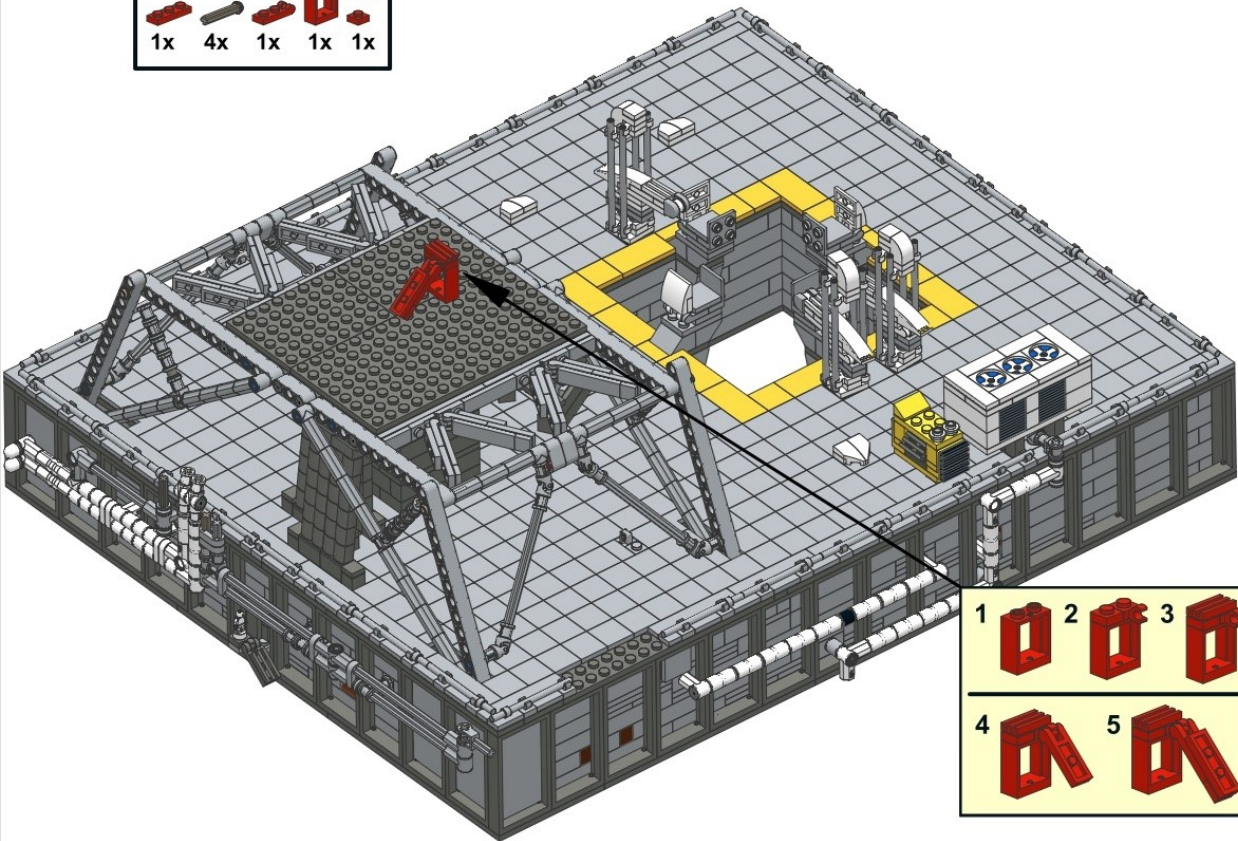
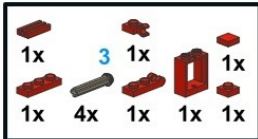



# 135

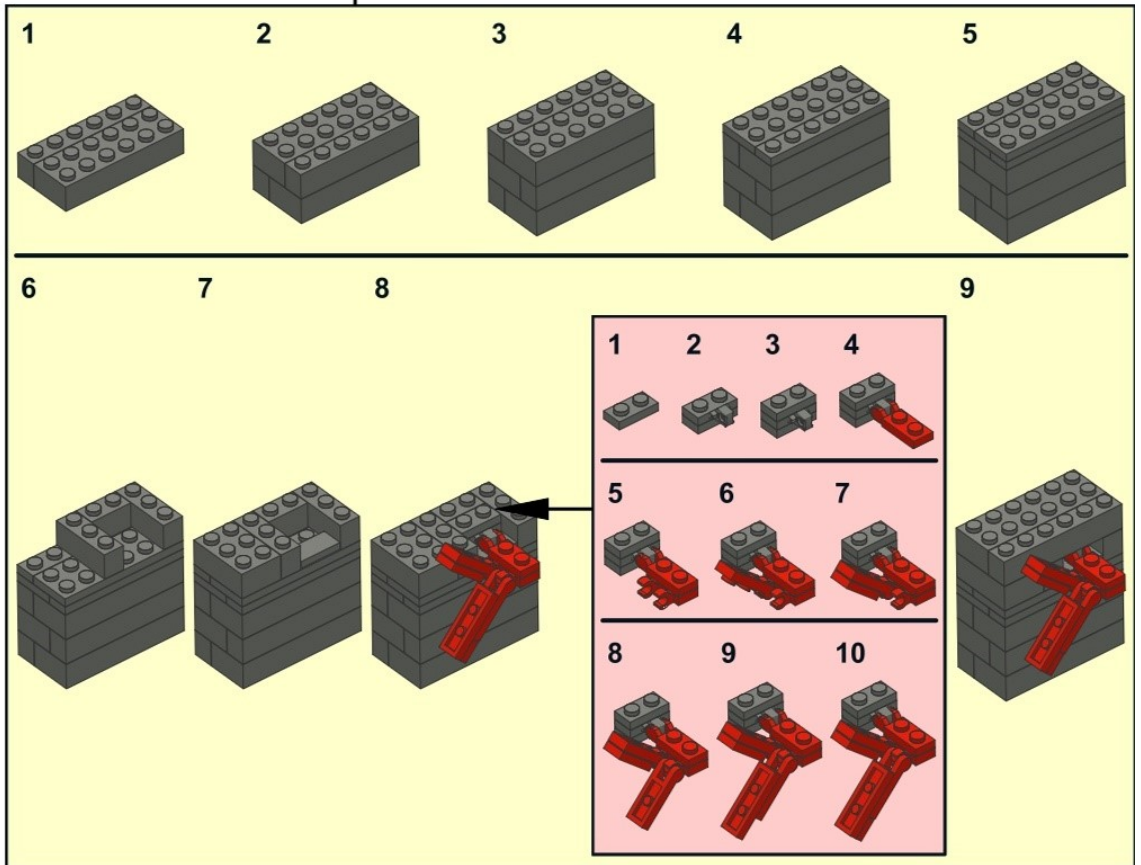
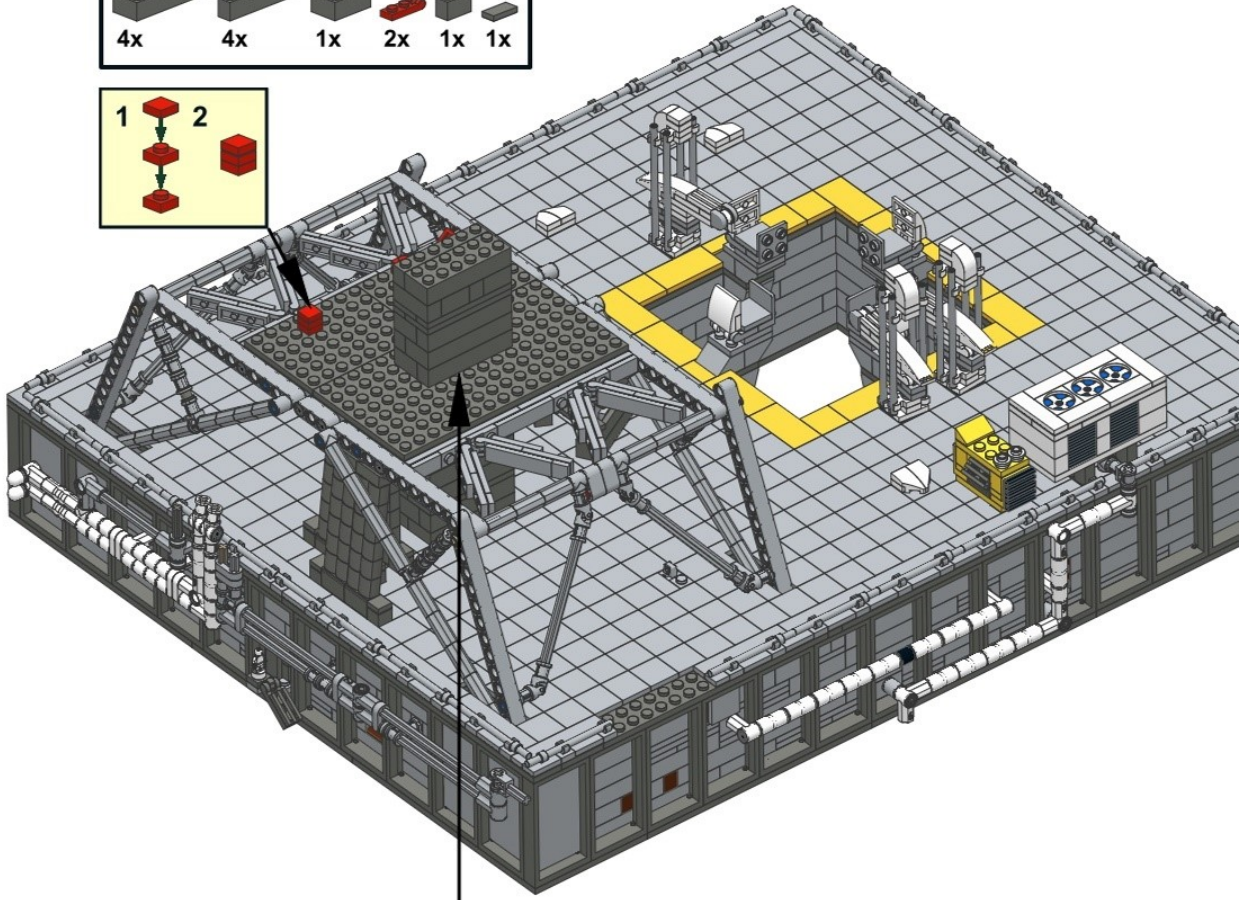
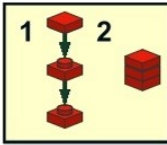
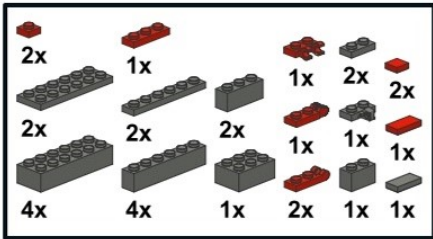



# 136

- |    |    |    |    |    |    |    |    |    |    |
|----|----|----|----|----|----|----|----|----|----|
|    |    |    |    |    |    |    |    |    |    |
| 1x | 9  | 2x | 1x | 1x | 3x | 1x | 1x | 1x | 1x |
|    |    |    |    |    |    |    |    |    |    |
| 1x | 1x | 2x | 1x | 1x | 1x | 2x | 1x | 1x | 1x |

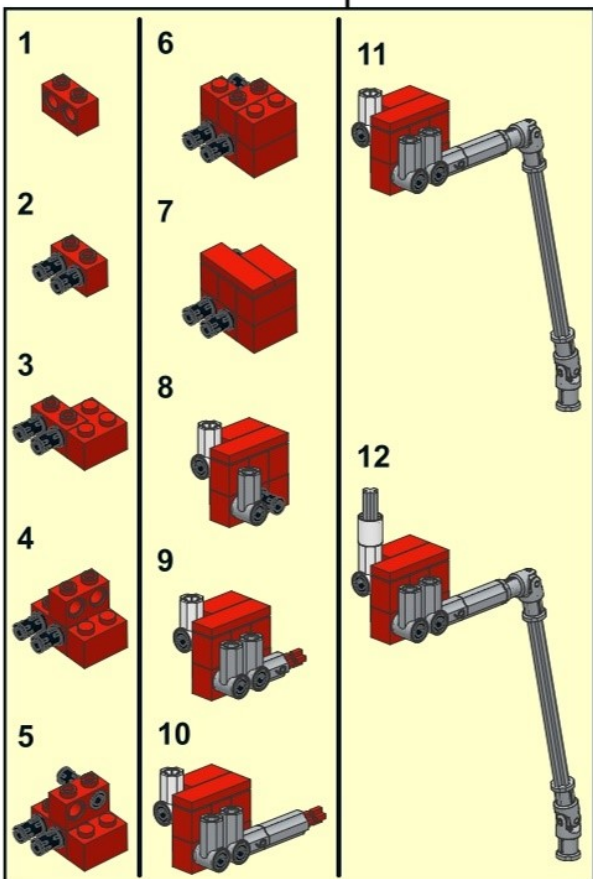
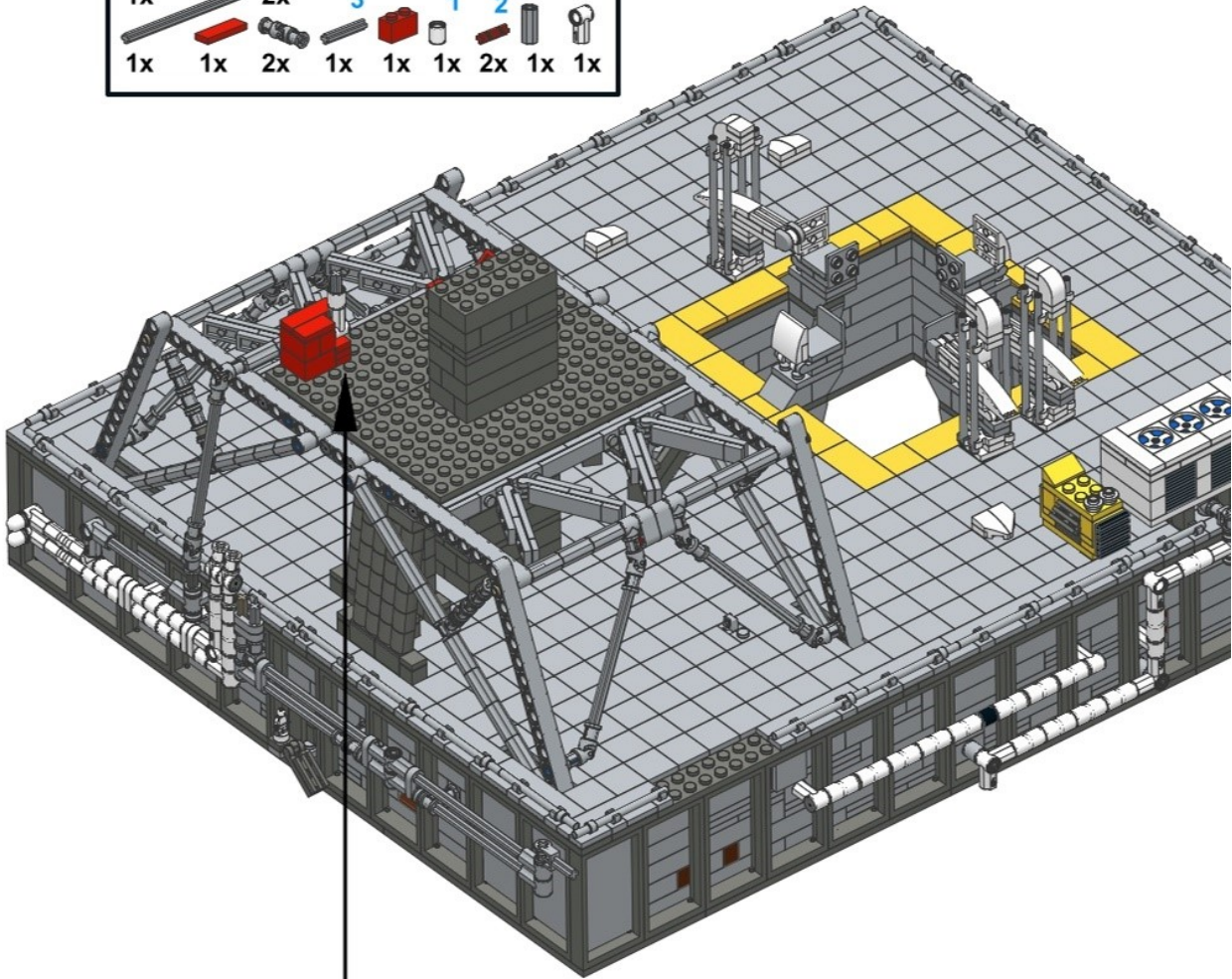



137

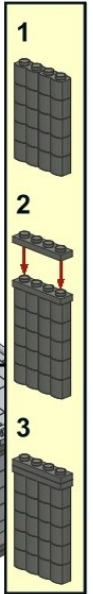
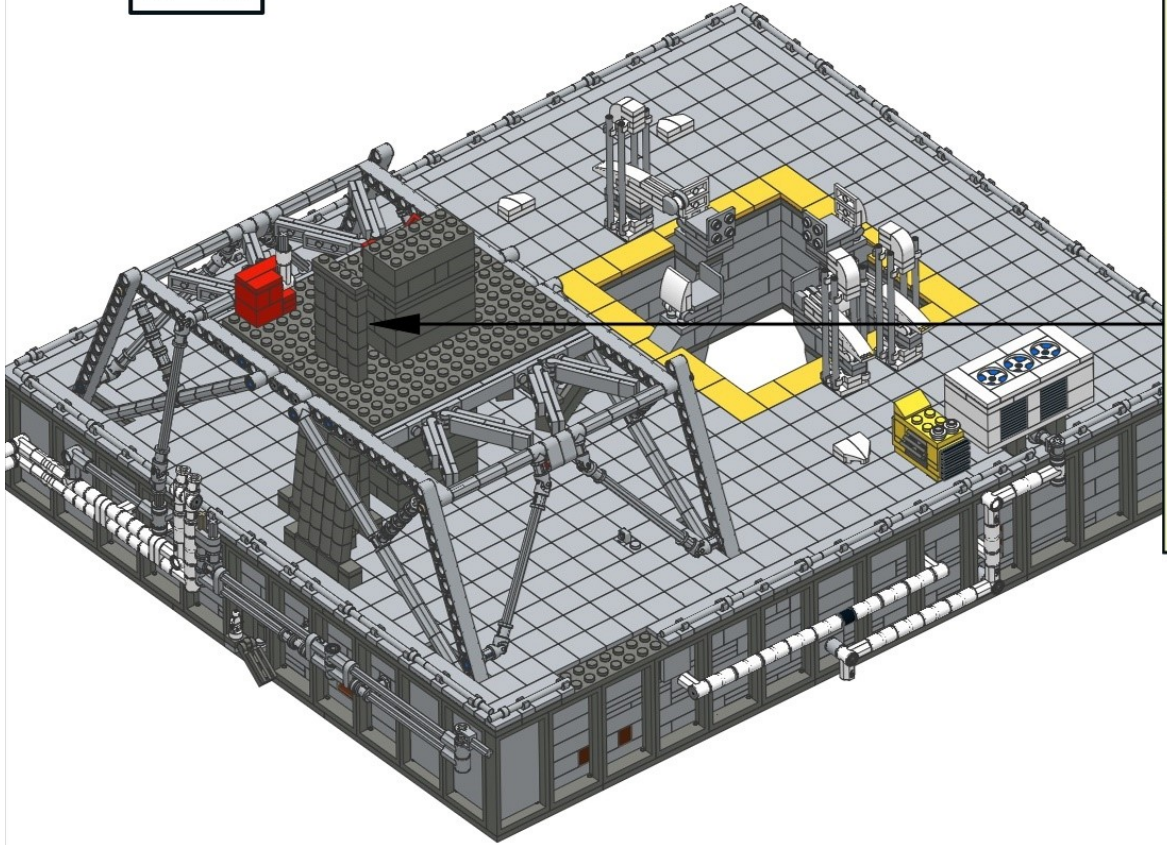
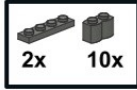

138

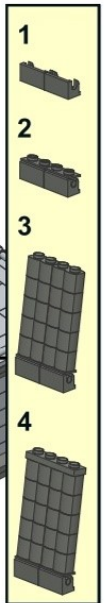
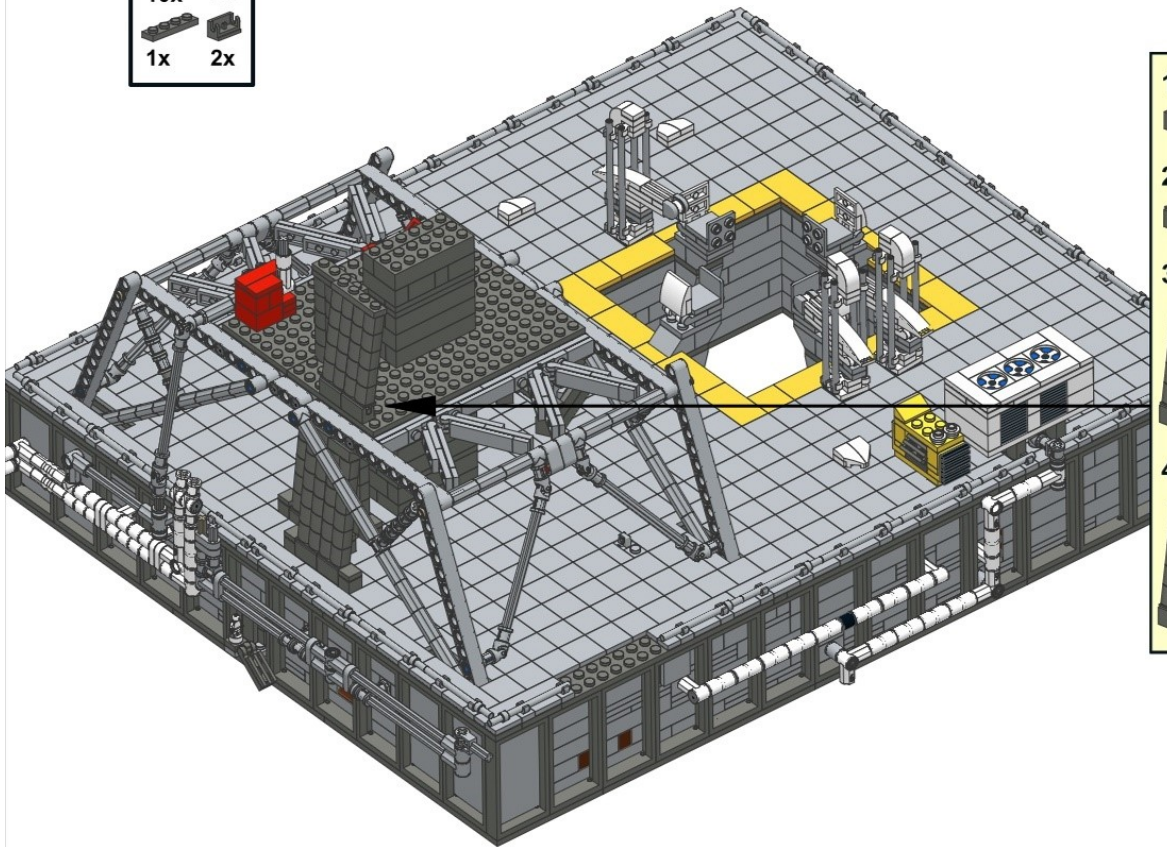
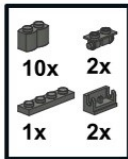



1  
1x 2x



2  
1x 4x



3  
4x 12x

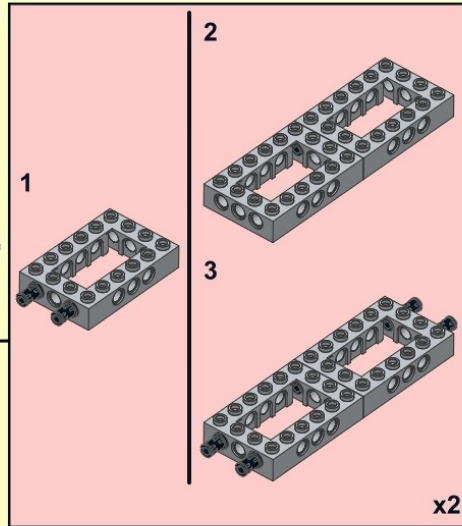
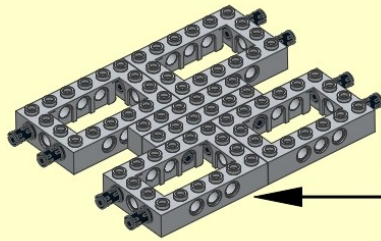

4  
3x 8x

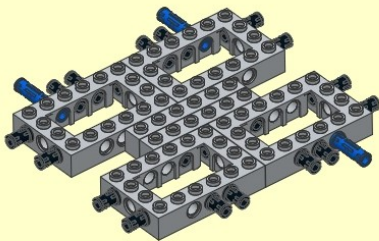

5  
2x 2x

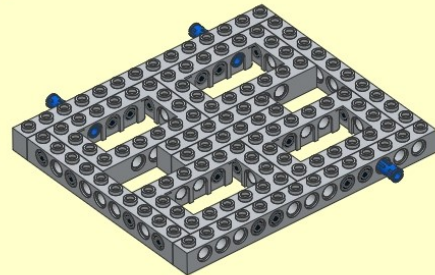

6  
1x

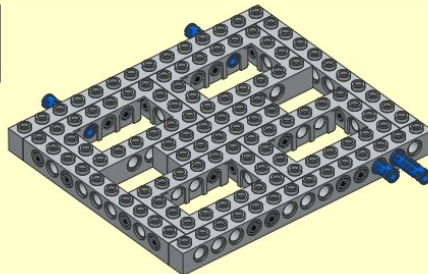

7

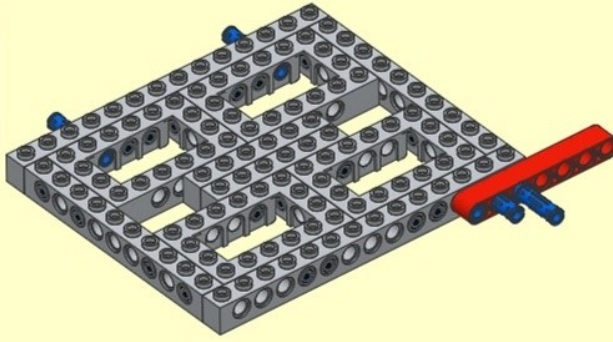
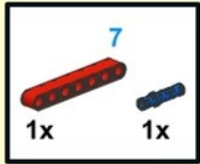

8

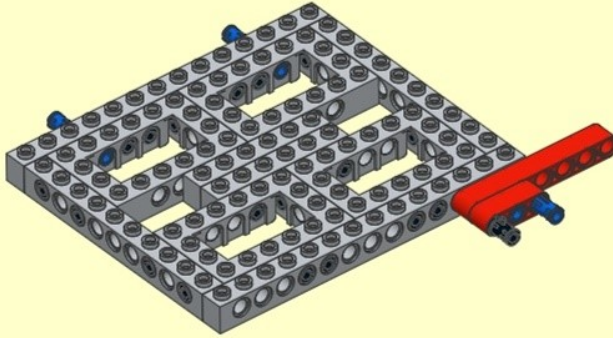
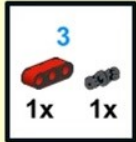

9

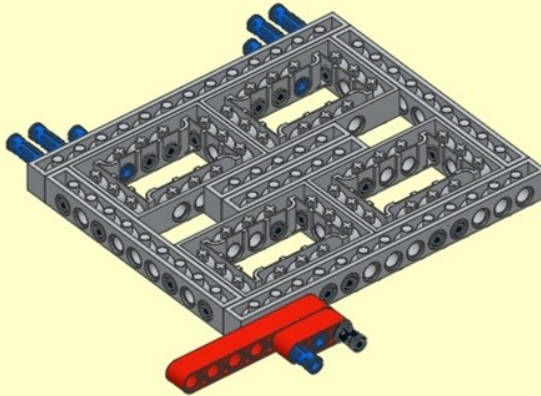

10

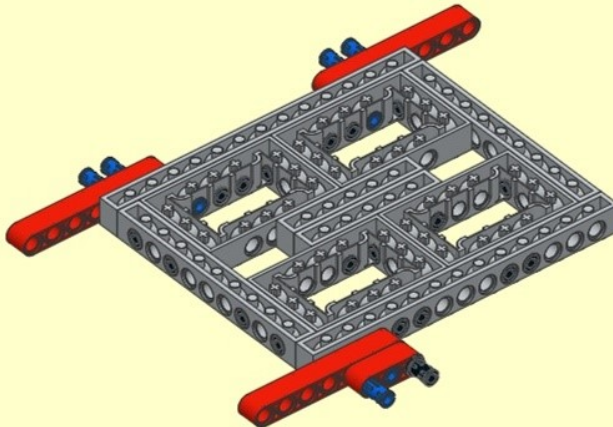
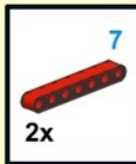



11

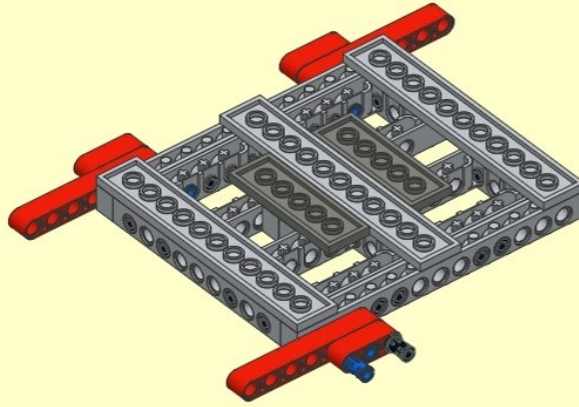
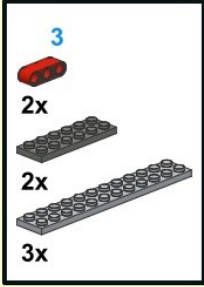

12

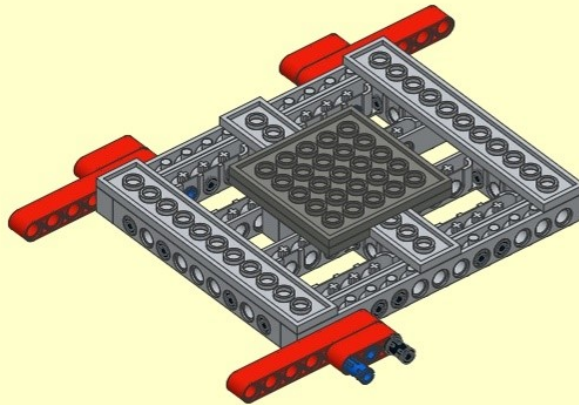
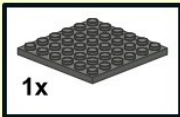

13

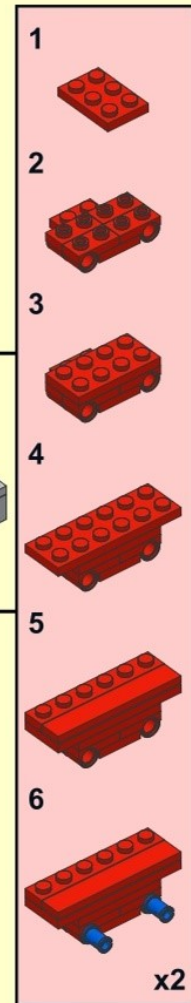
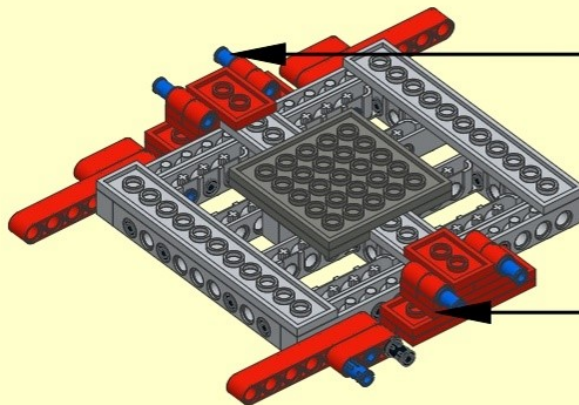
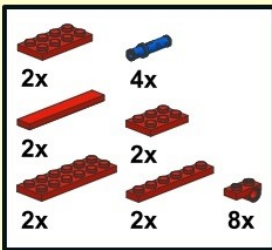

14

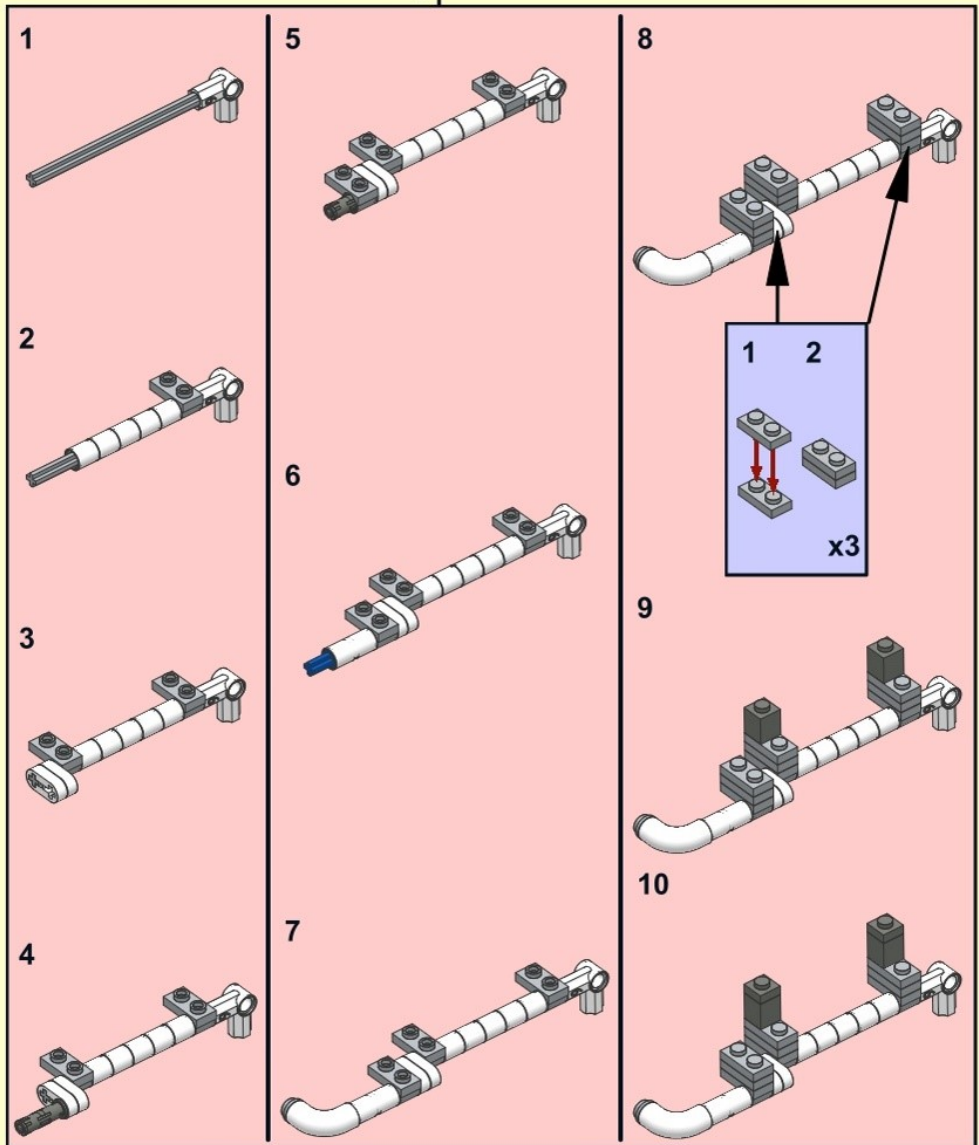
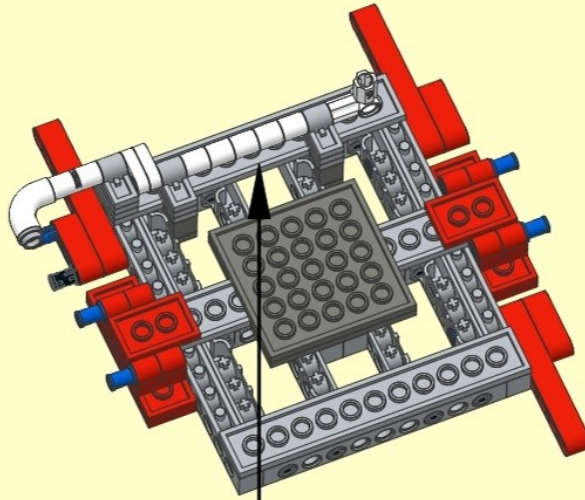
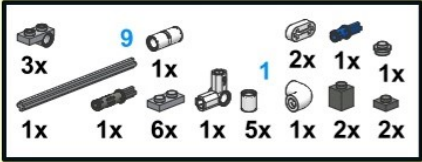



15

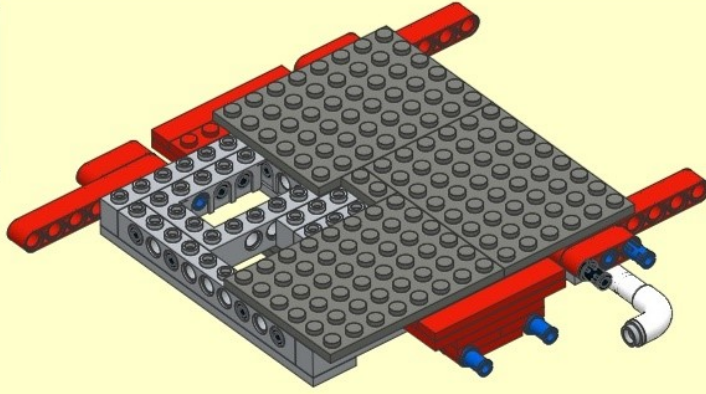
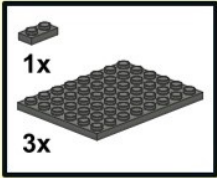

16

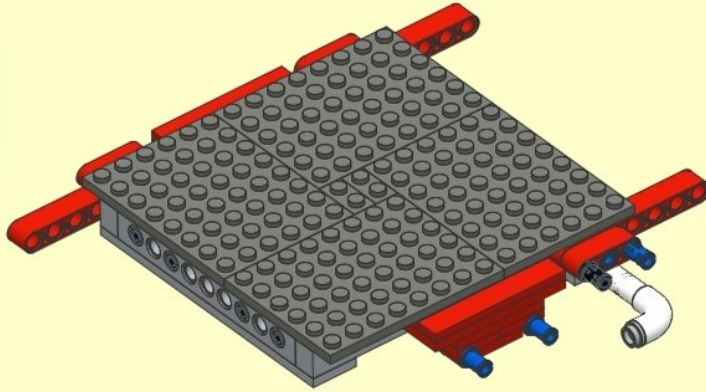
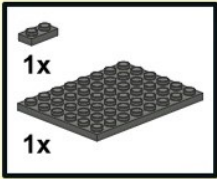

139

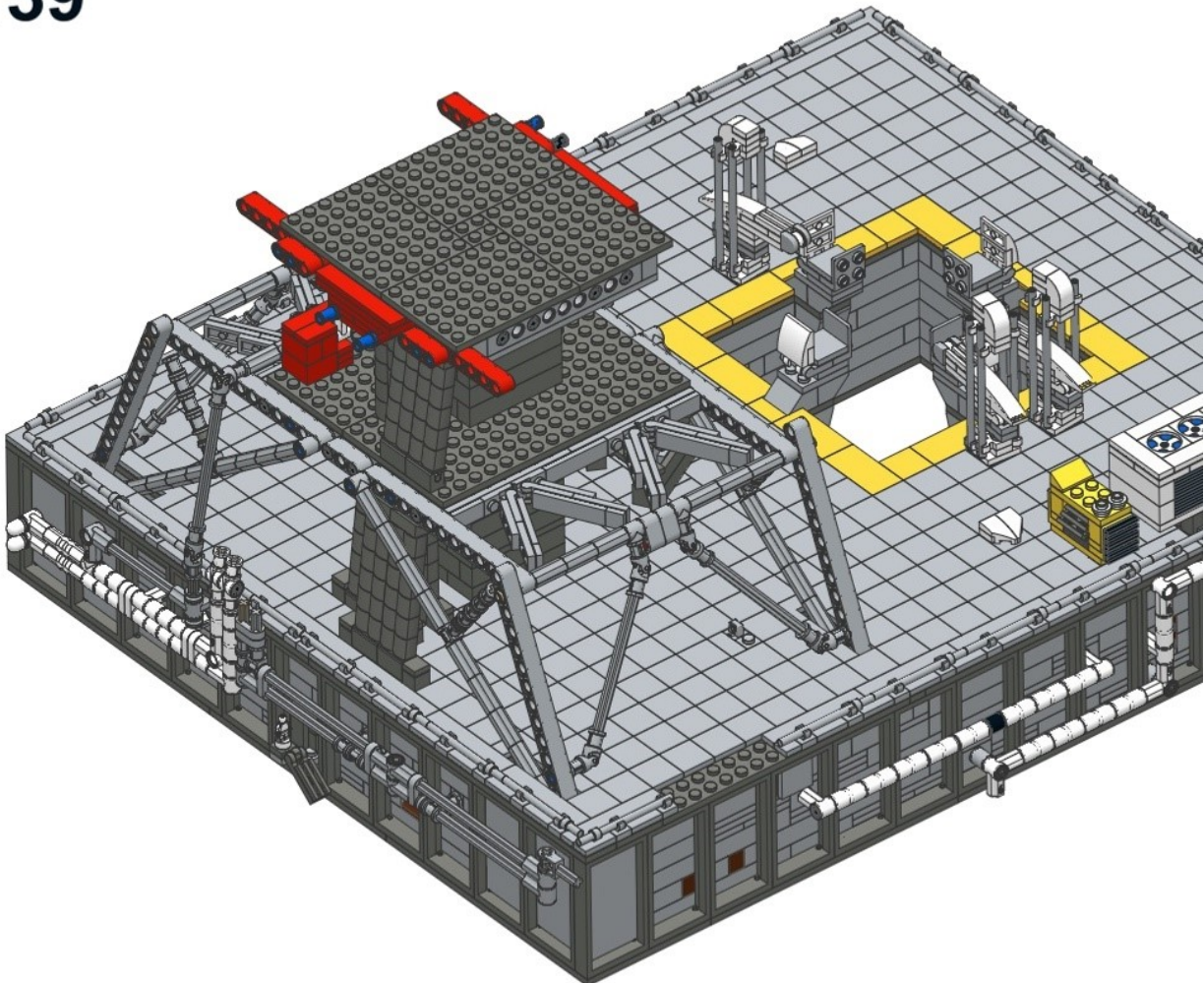



# 140

- |     |     |    |    |
|-----|-----|----|----|
|     |     |    |    |
| 12x | 16x | 8x |    |
|     |     |    |    |
| 4x  | 20x | 4x | 8x |

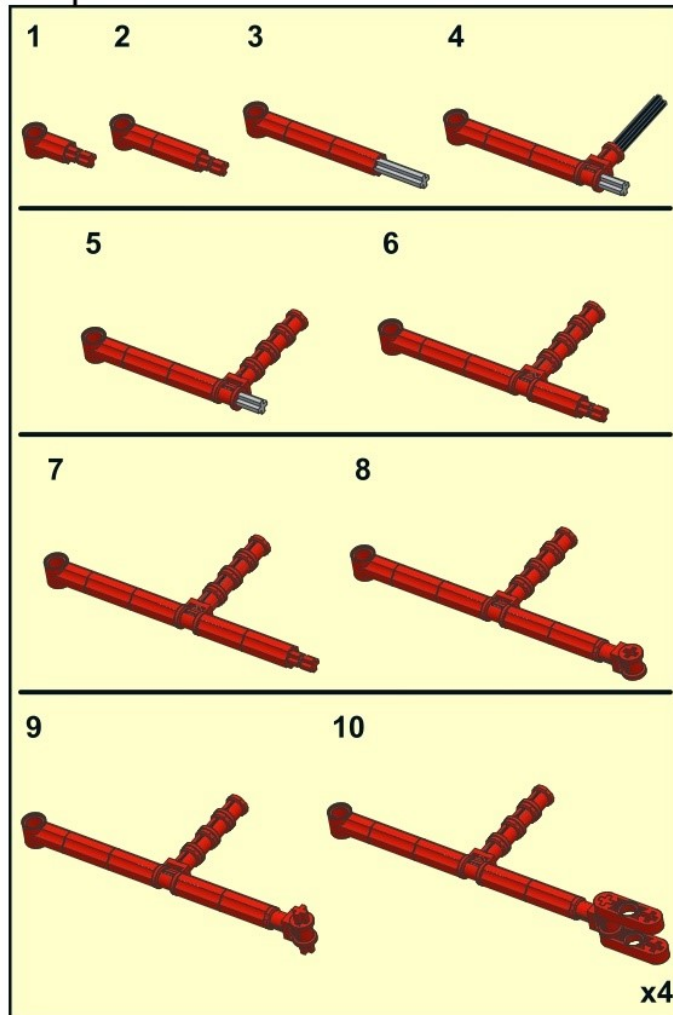
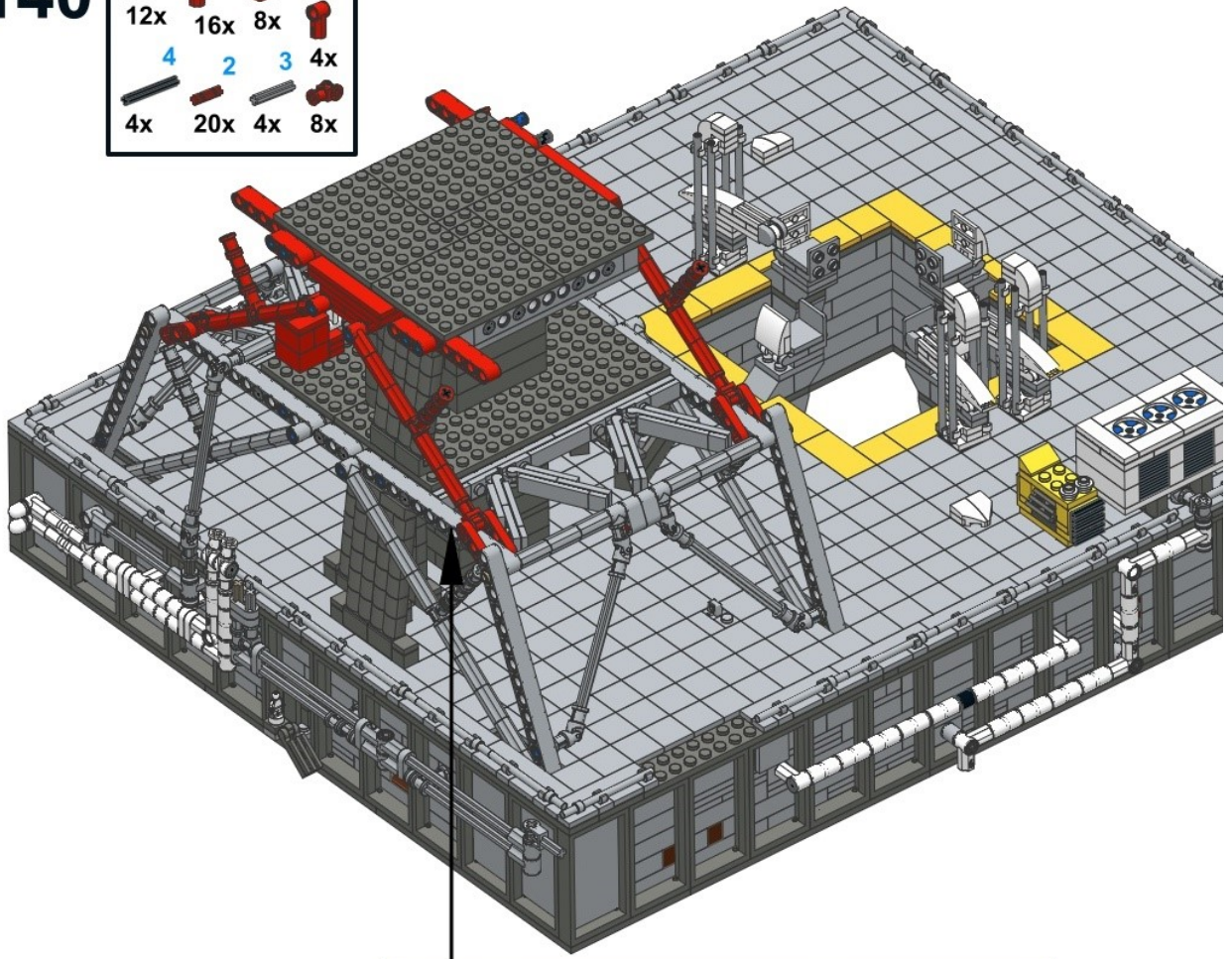



141

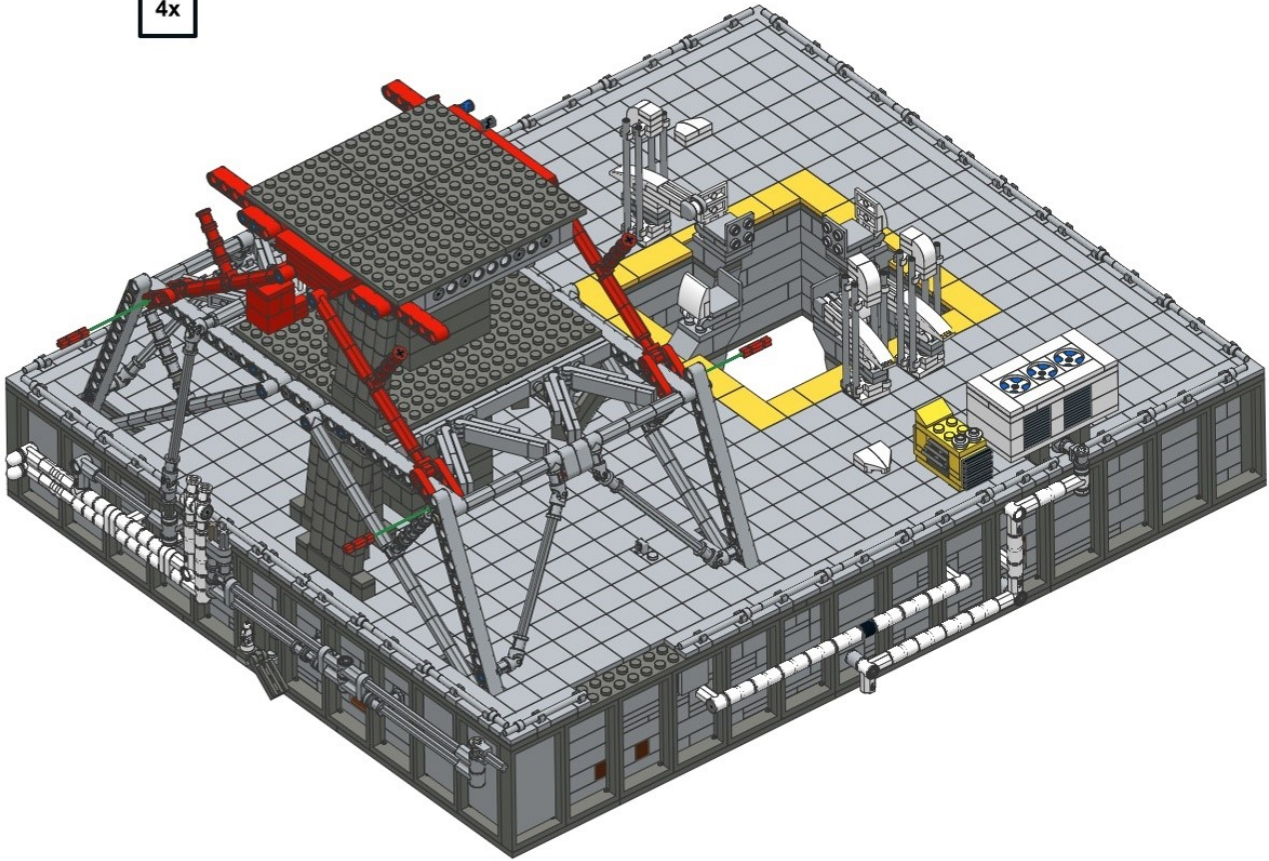

142

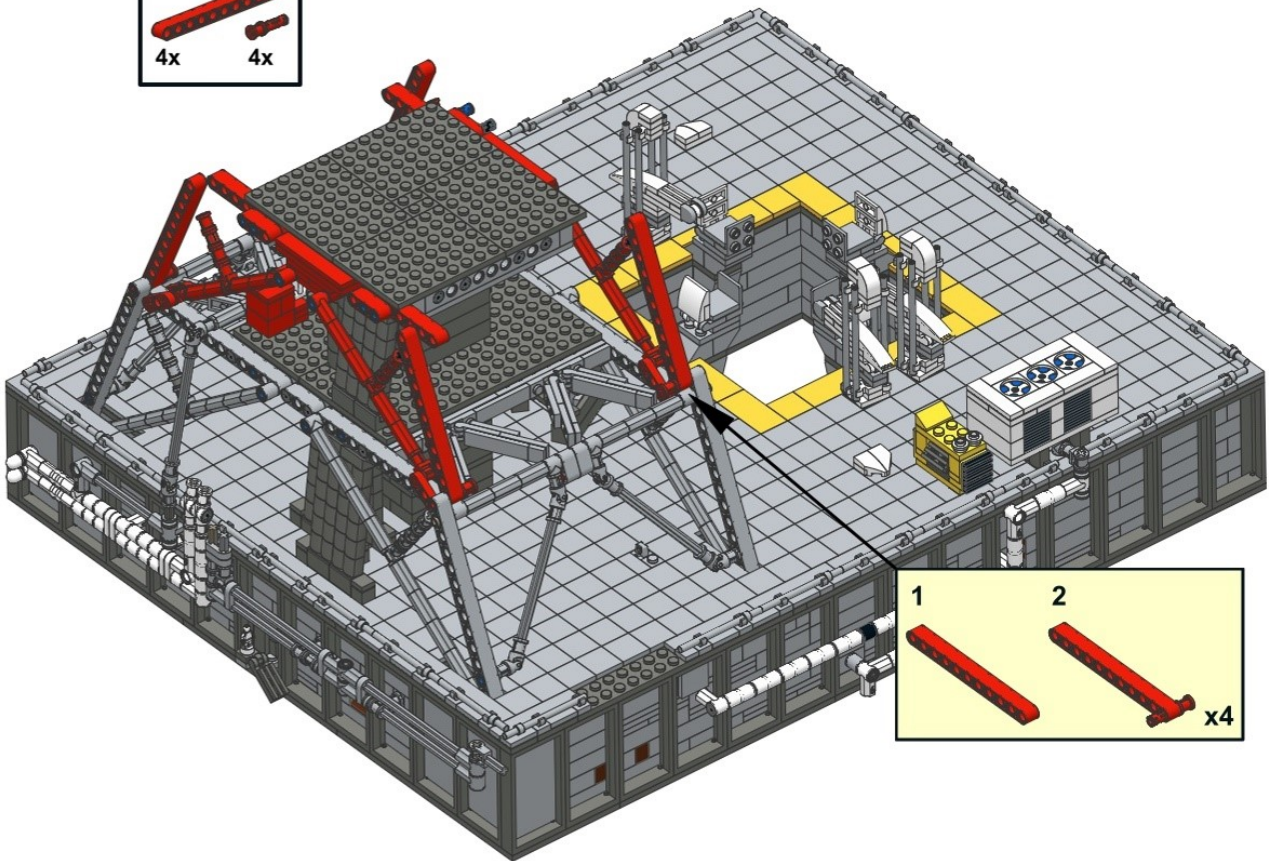
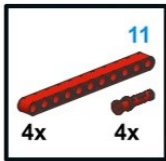

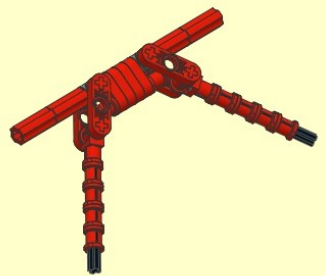
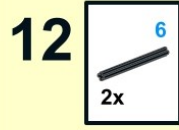
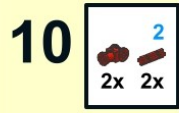
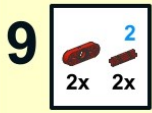
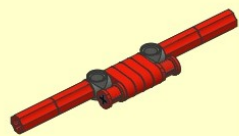
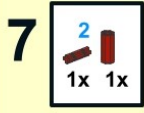
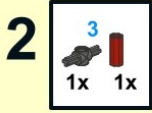
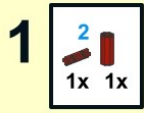



15  2  
2x

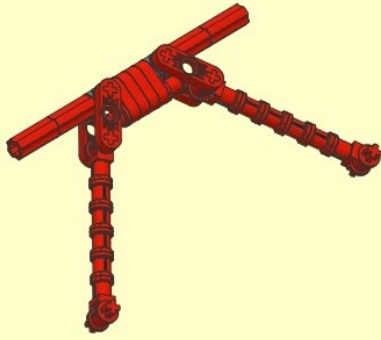

16   2x 2x



17  2x



18  2x



143

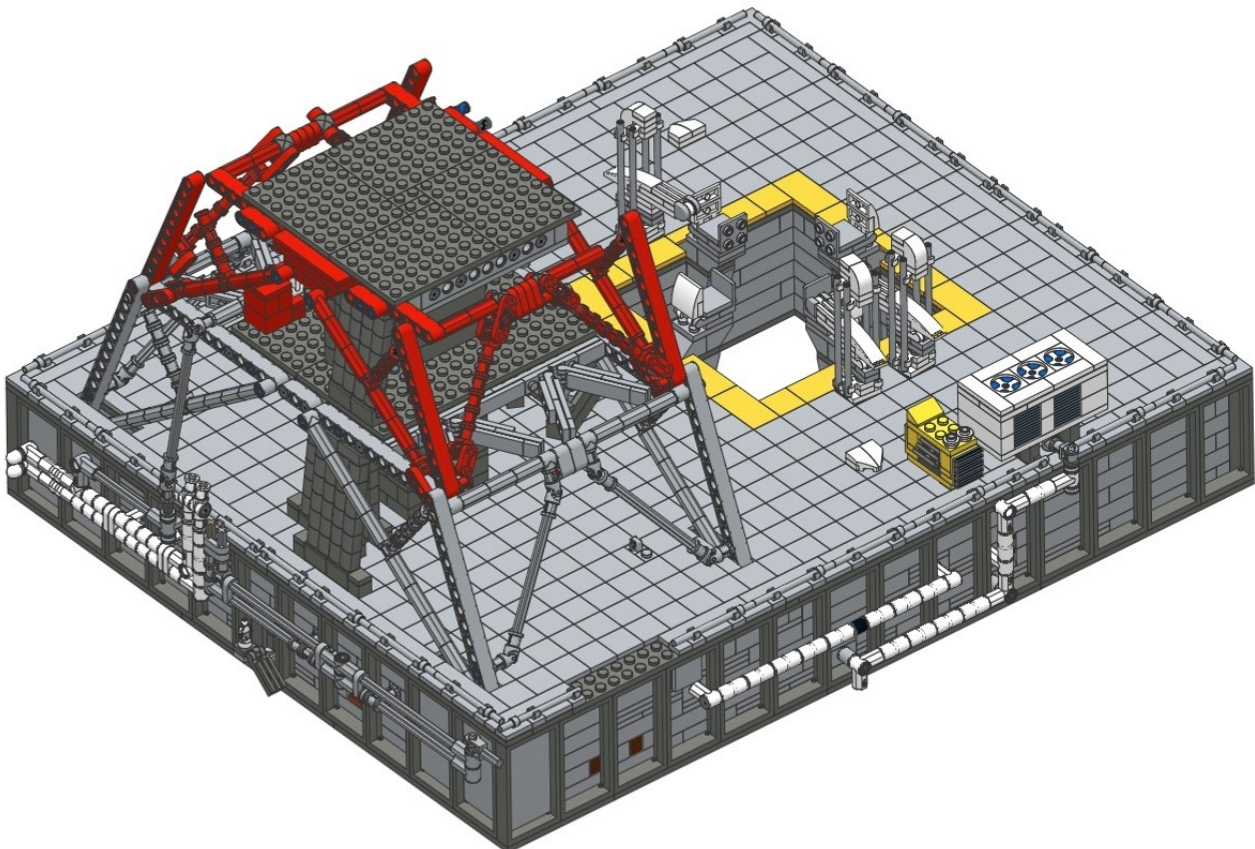

144

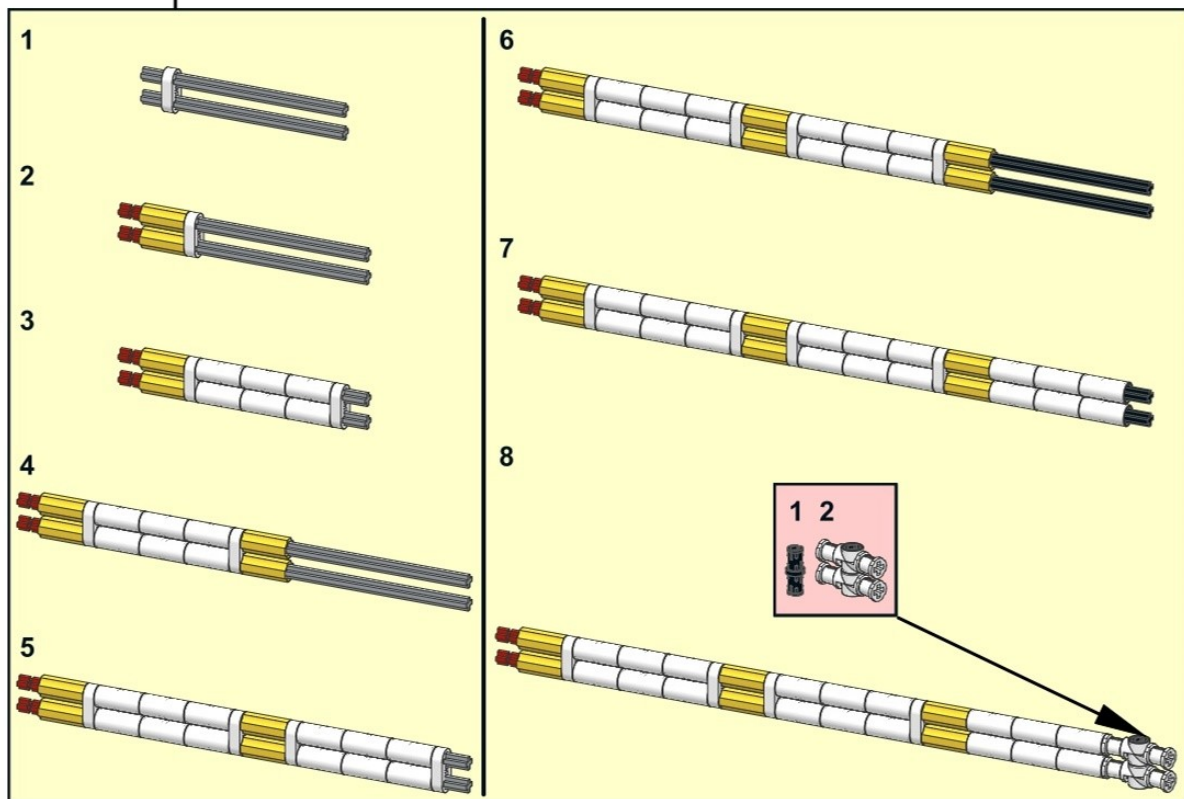
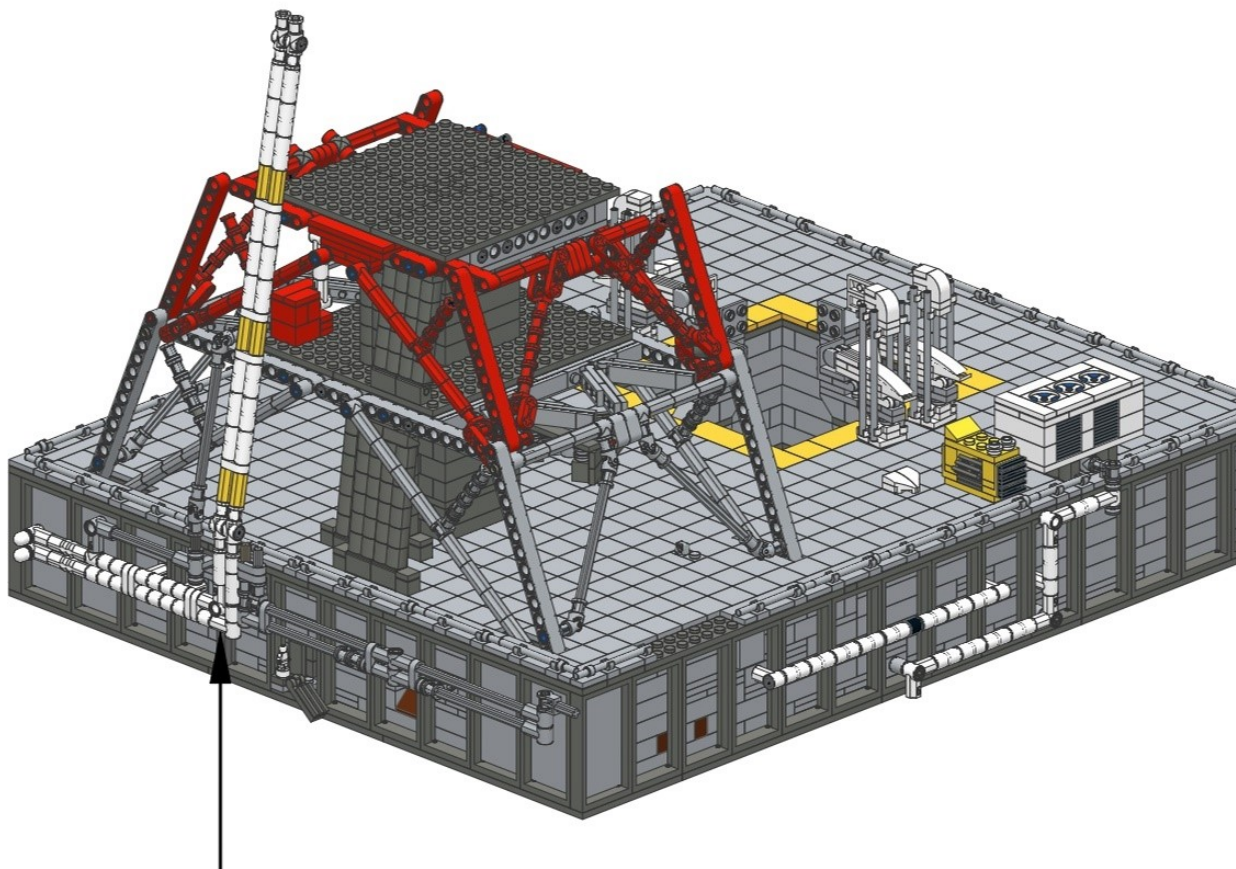



145

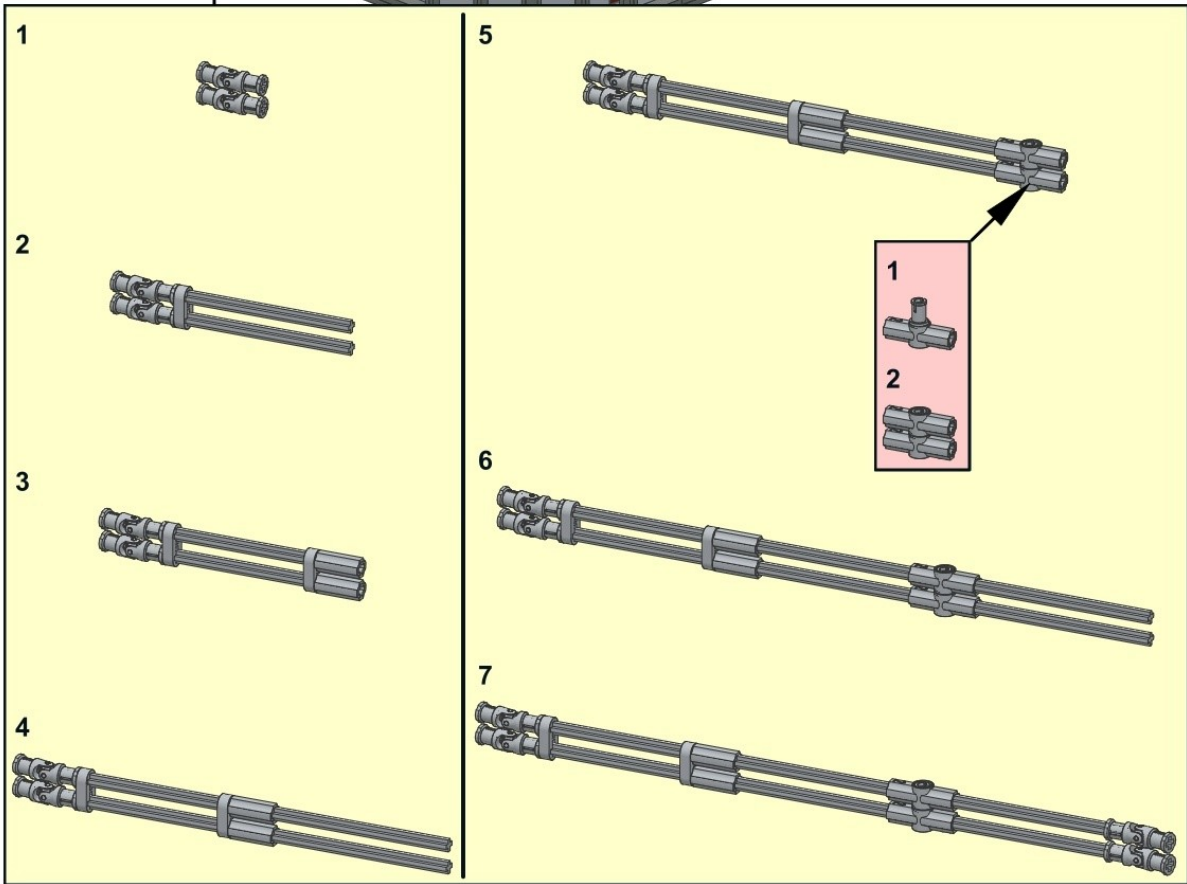
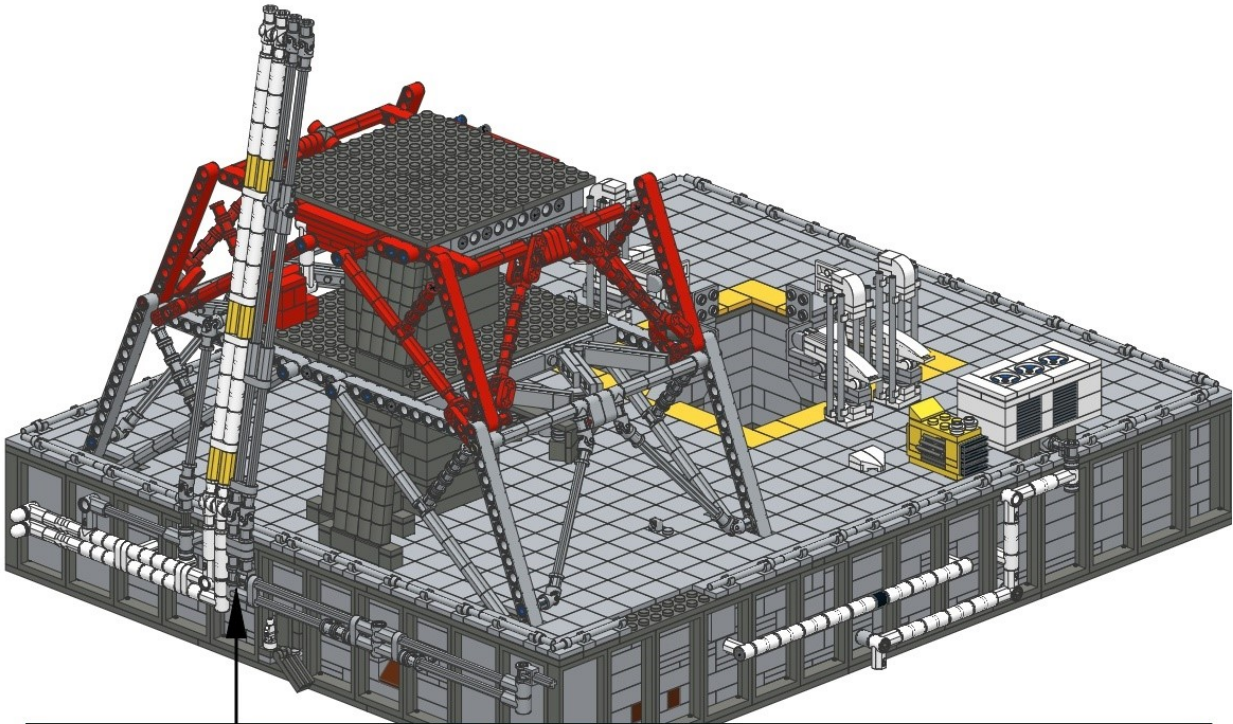
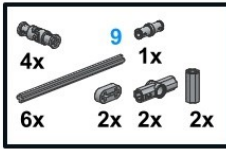

146

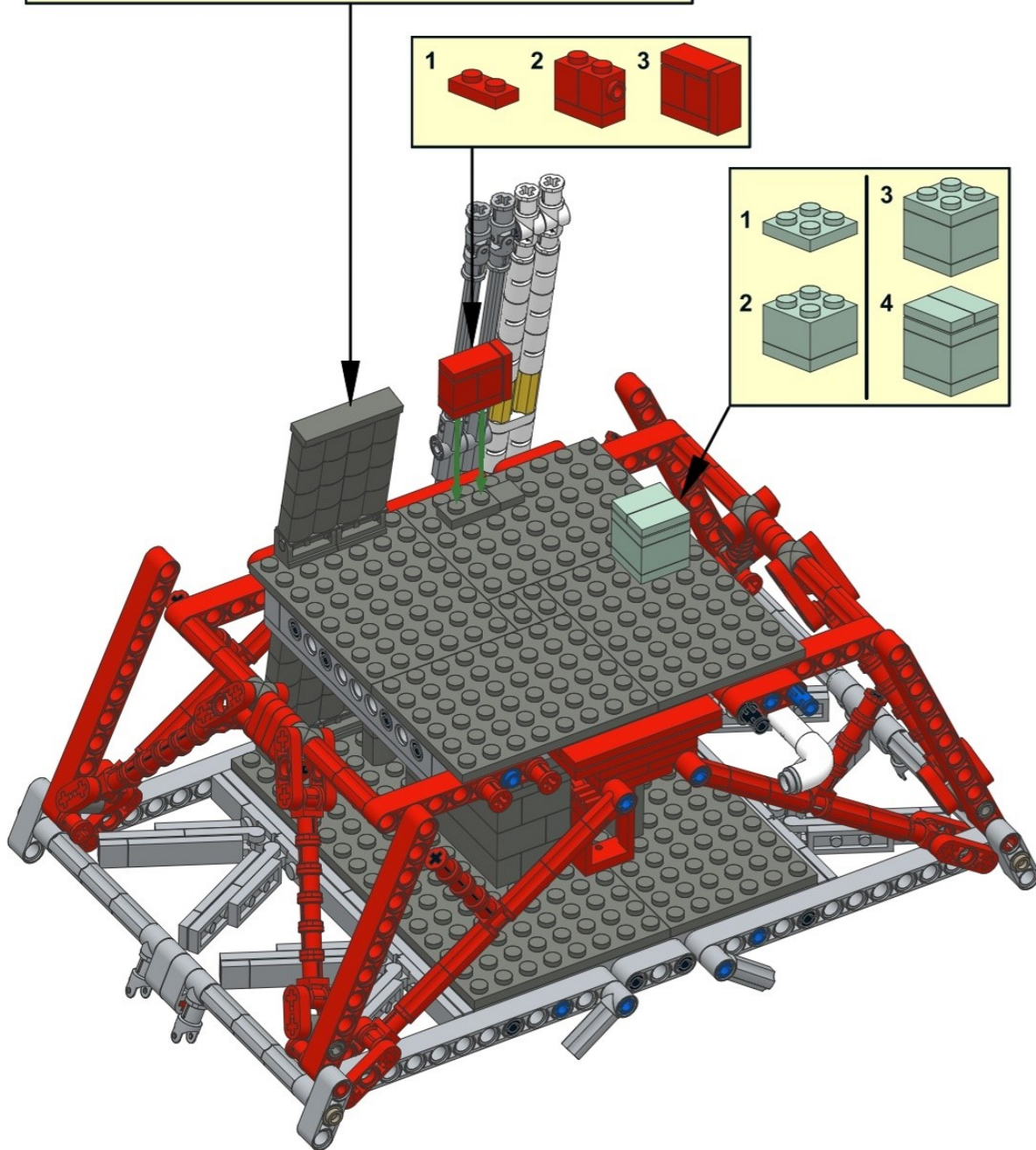
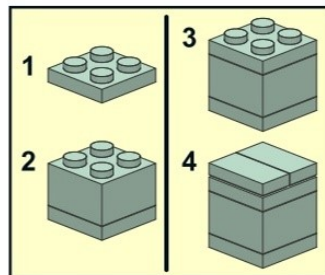
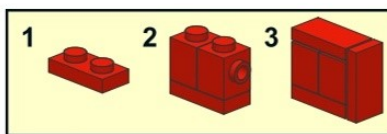
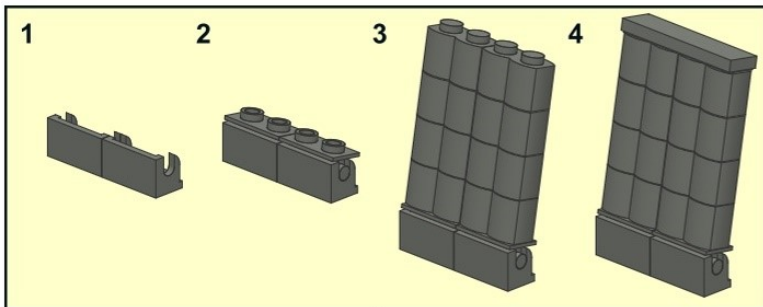
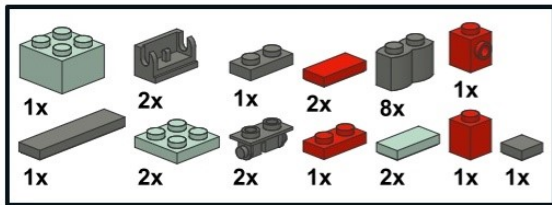



147

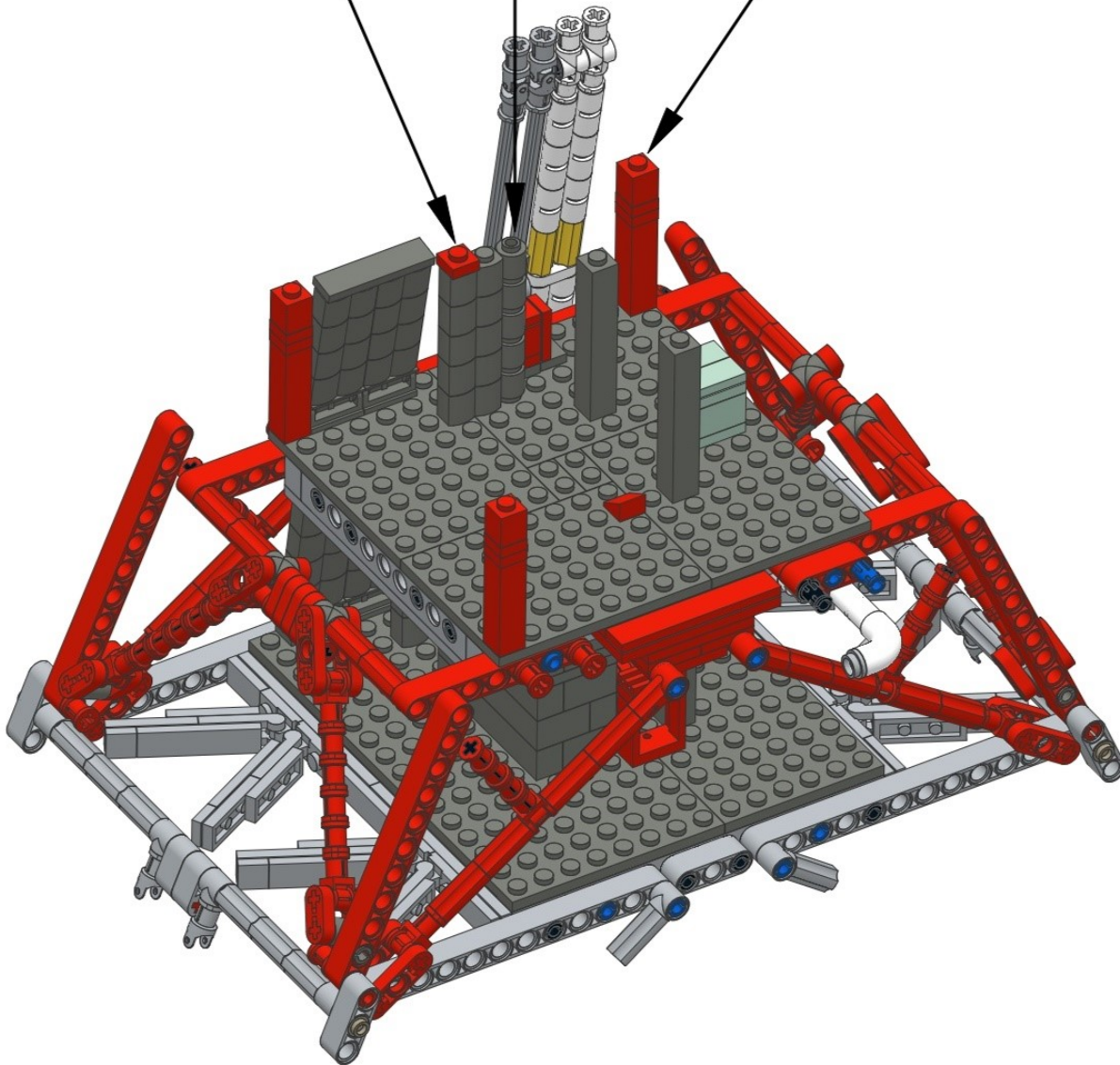
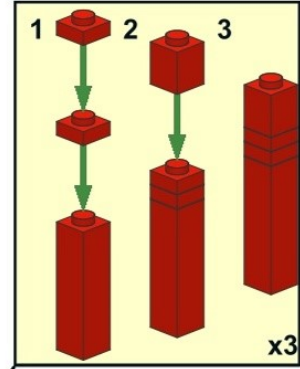
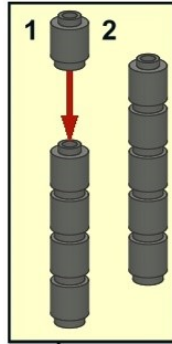
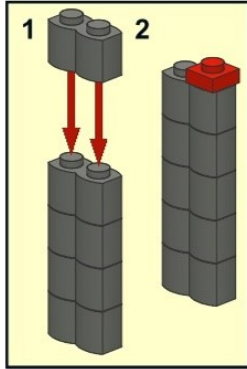
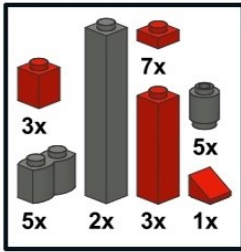

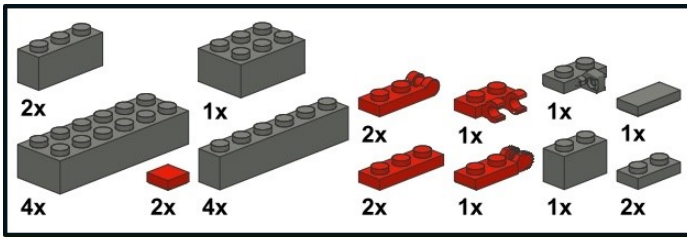

1

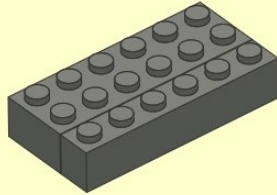

2

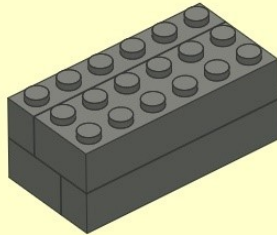

3

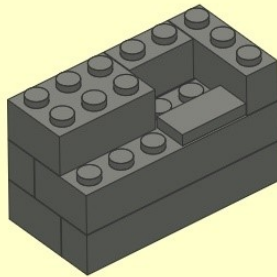

4

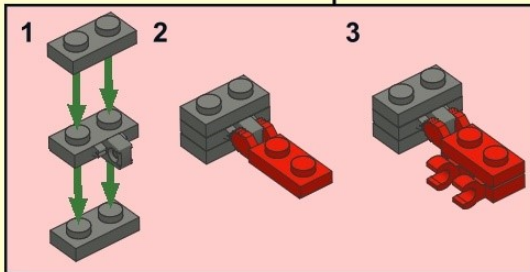
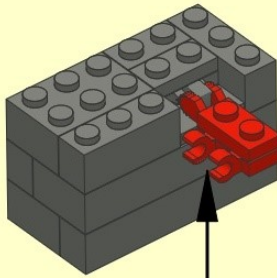

5

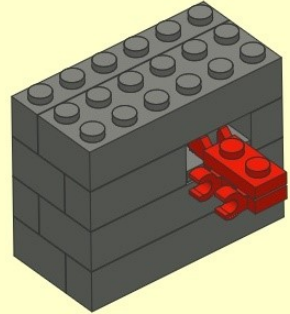

6

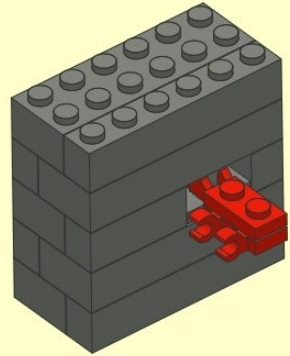

7

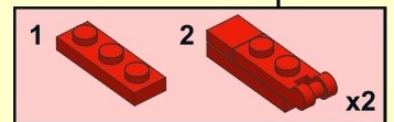
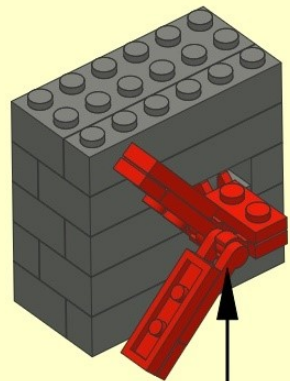



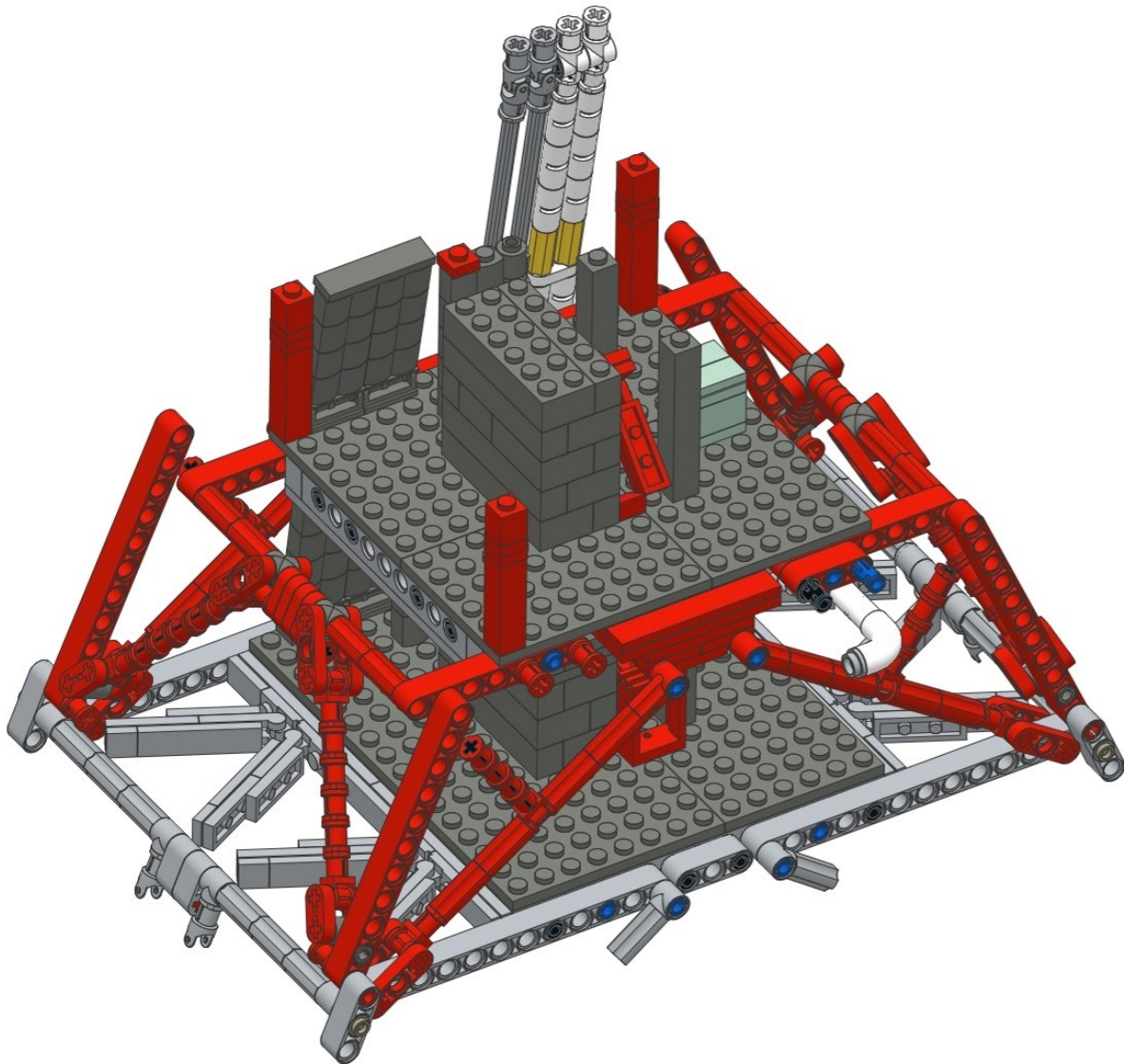

# 149

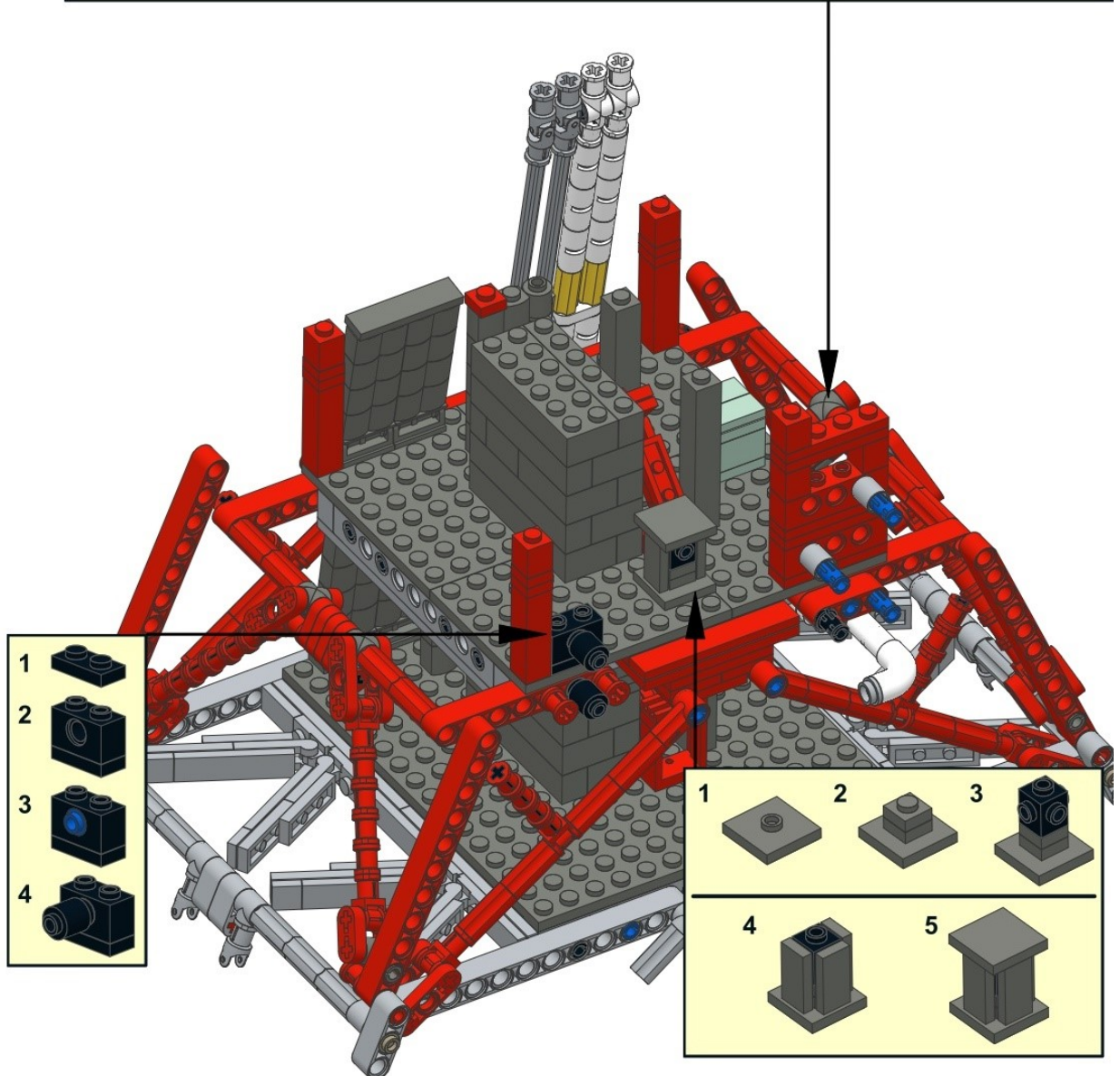
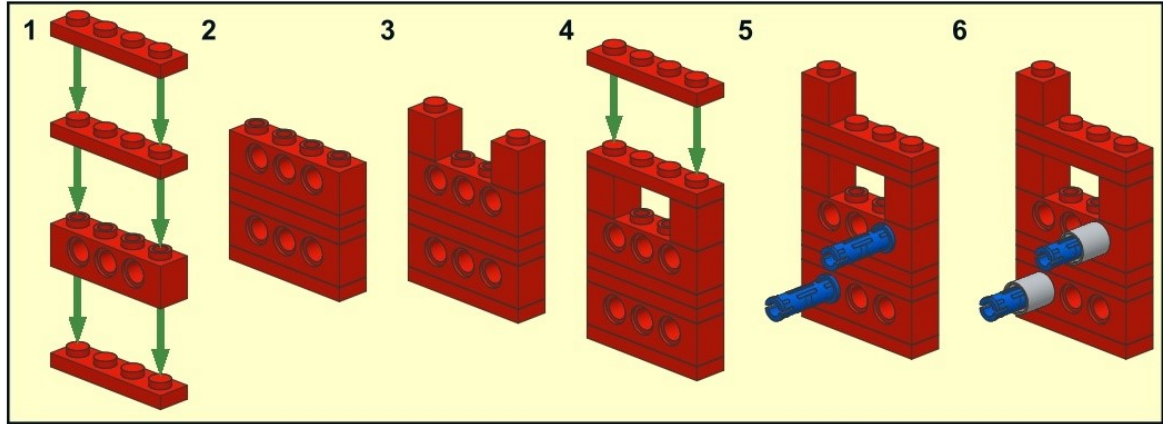
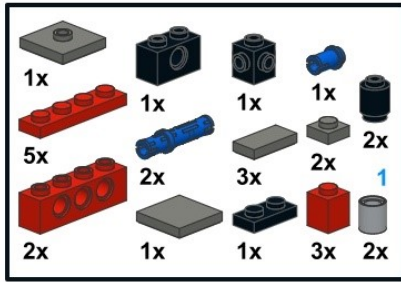



150

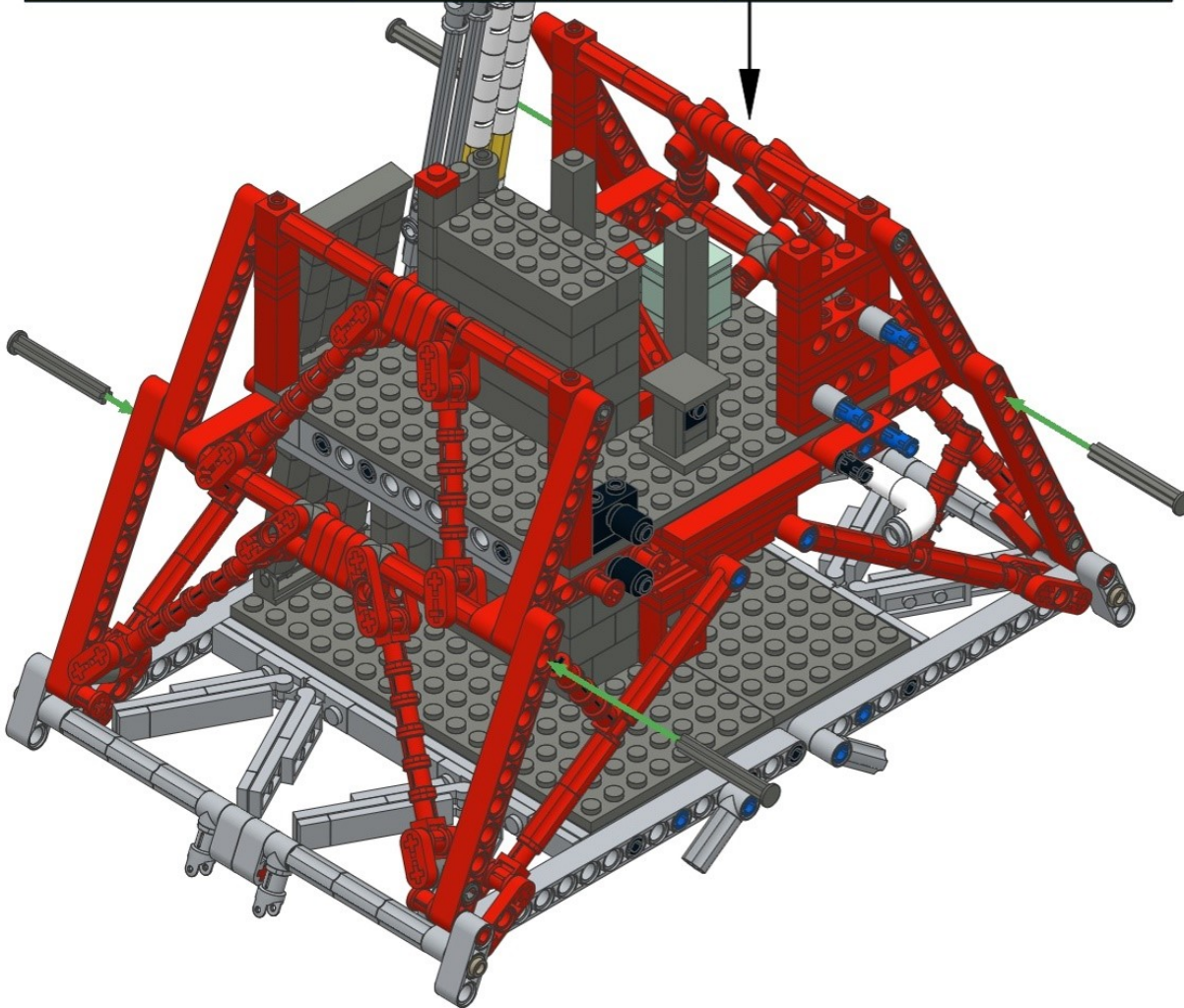
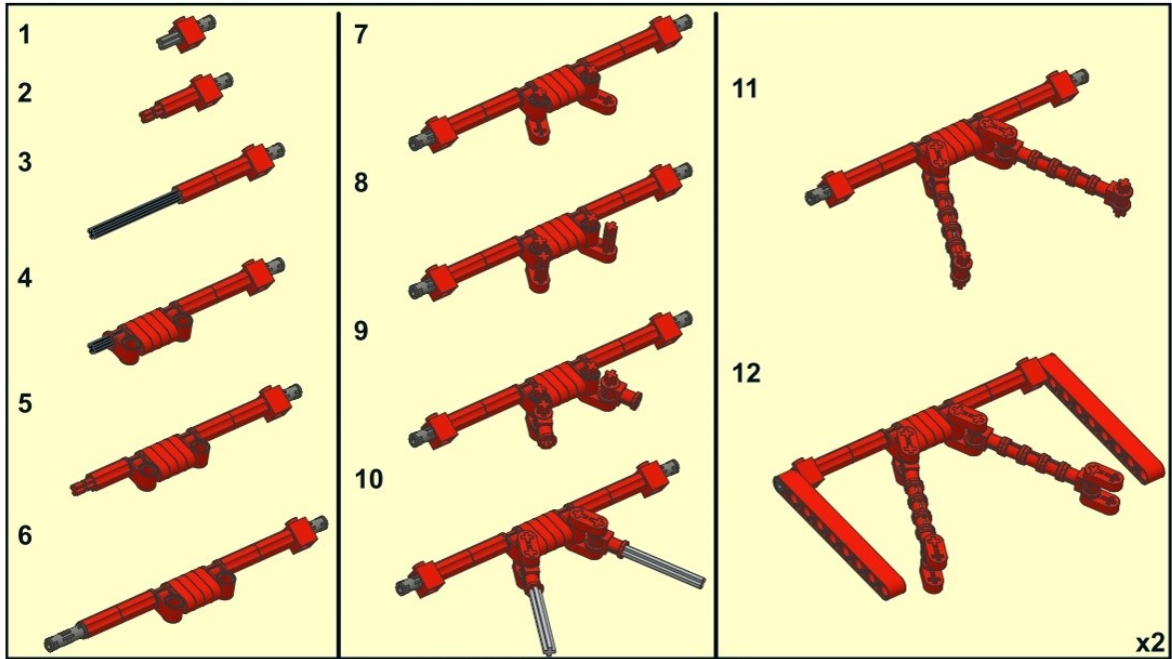
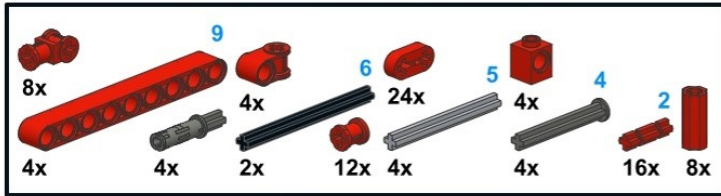

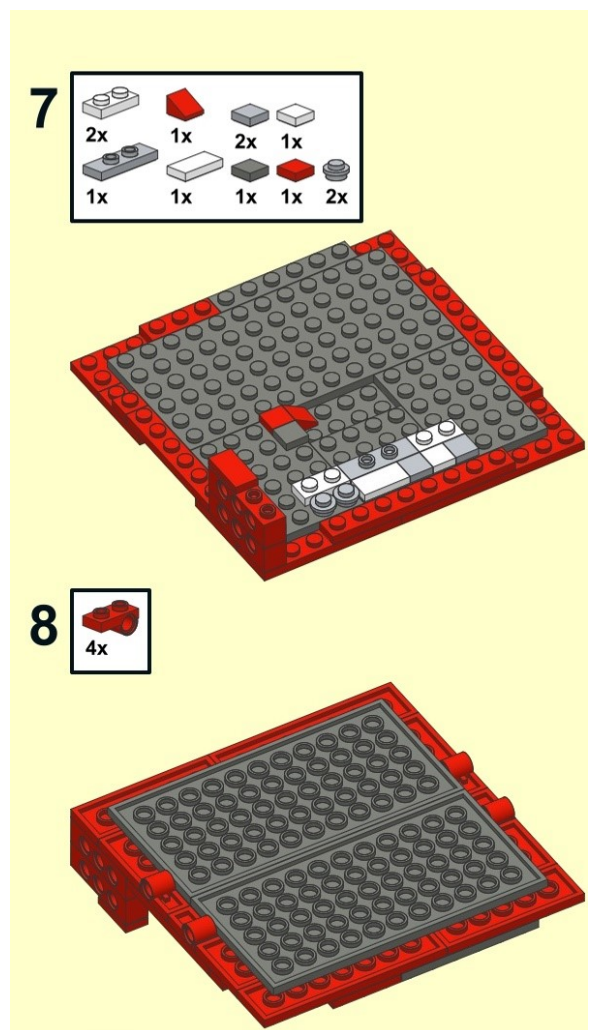
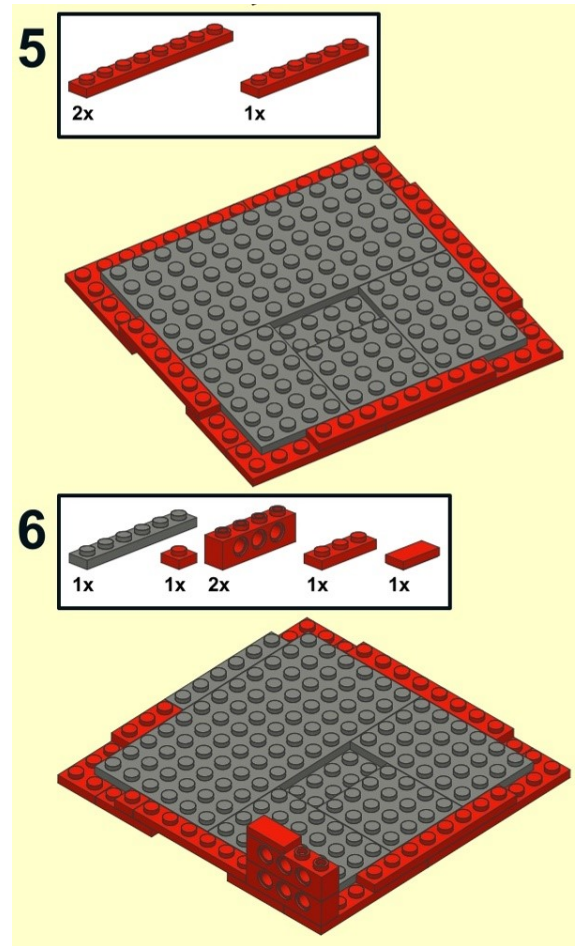
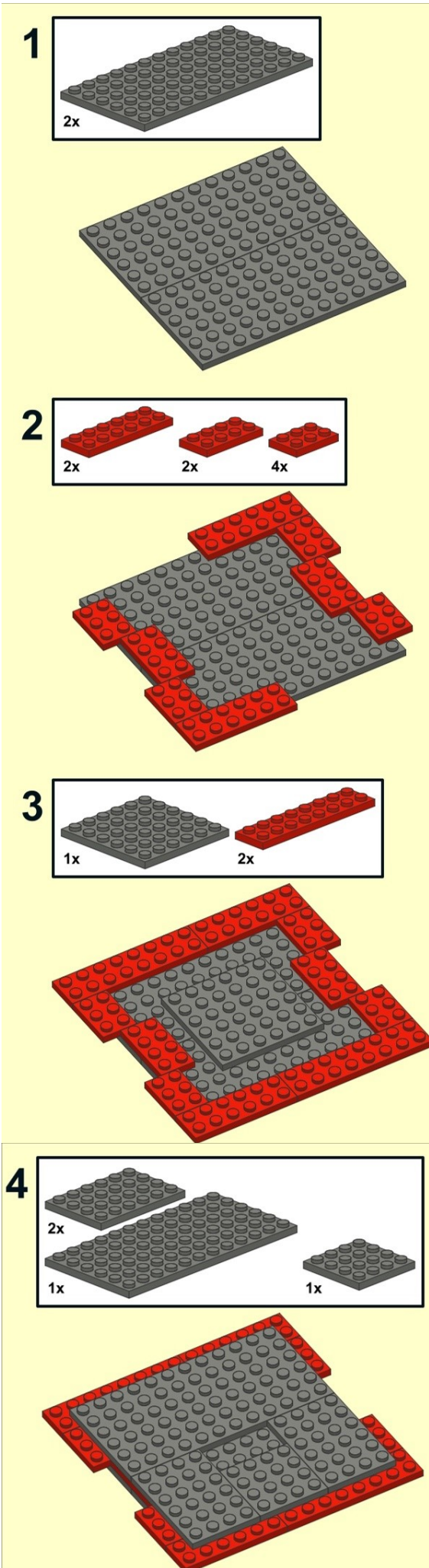





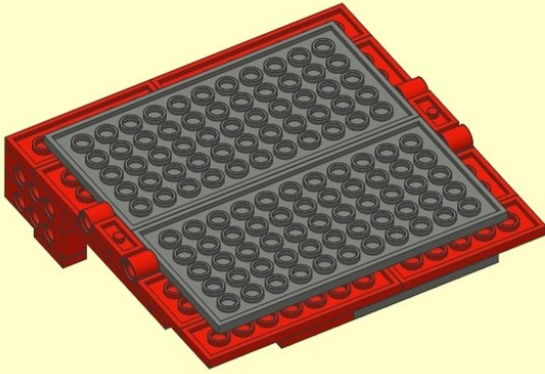



9  2x

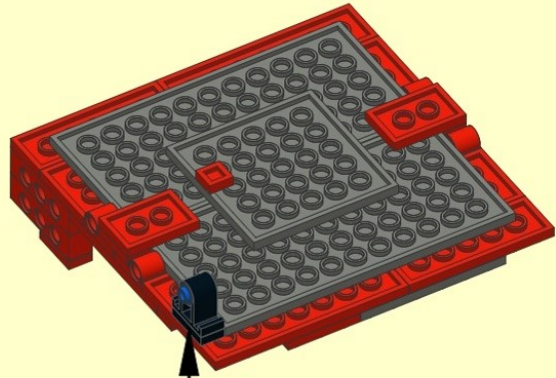

11    1x 1x 1x



10  2x  
 1x  
 1x

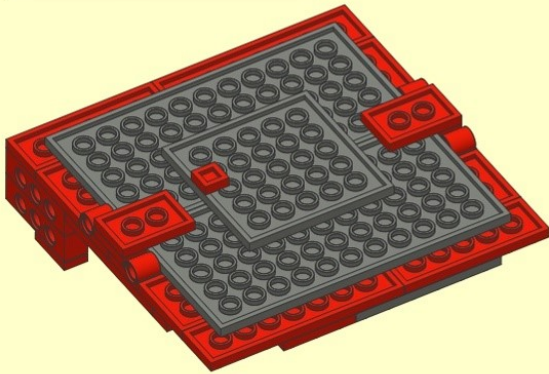

1  2  3 

151

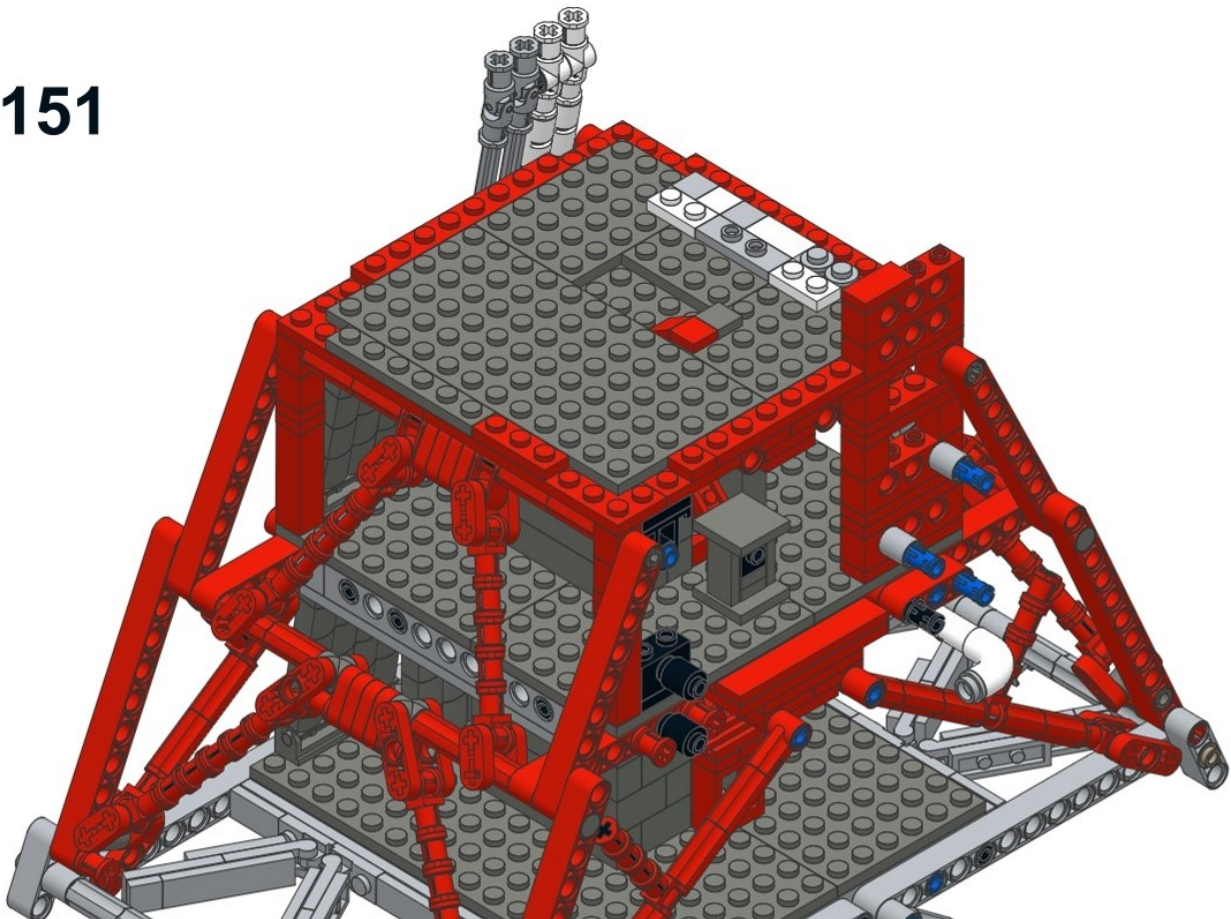

152

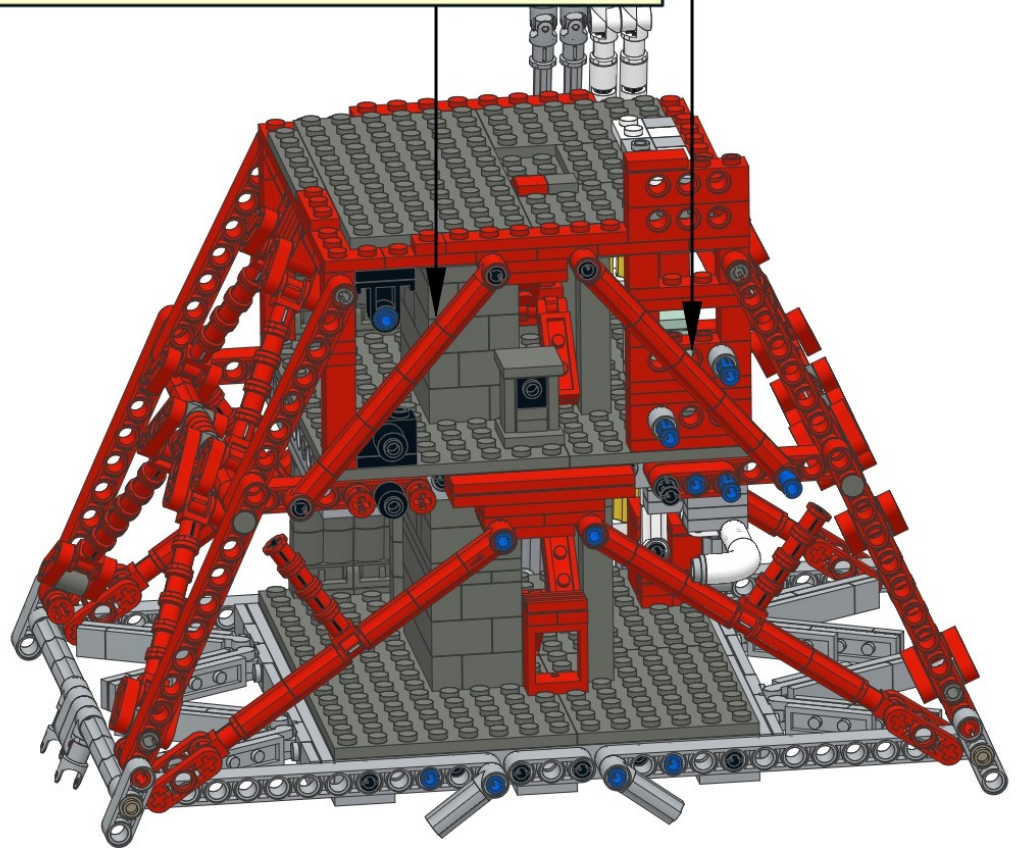
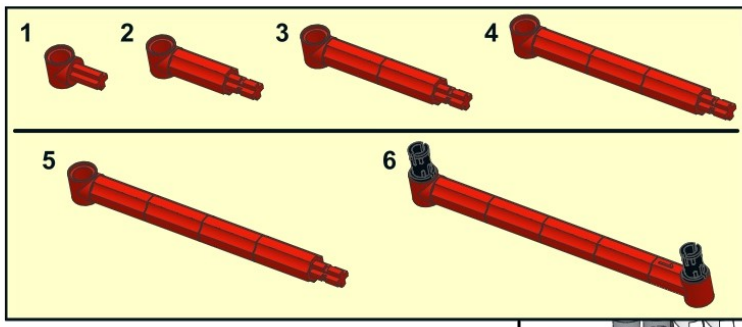
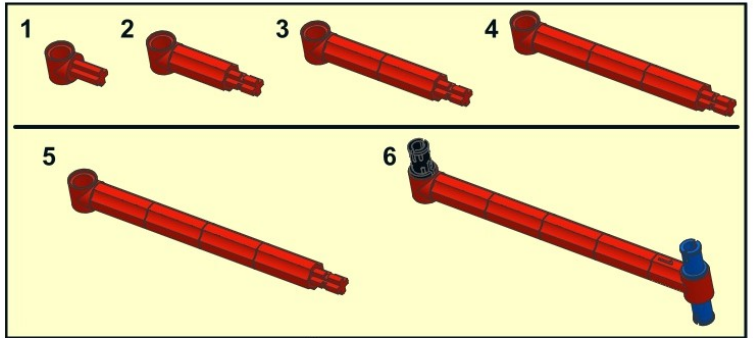
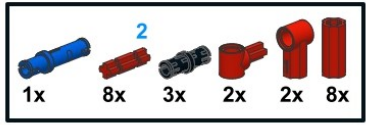



153

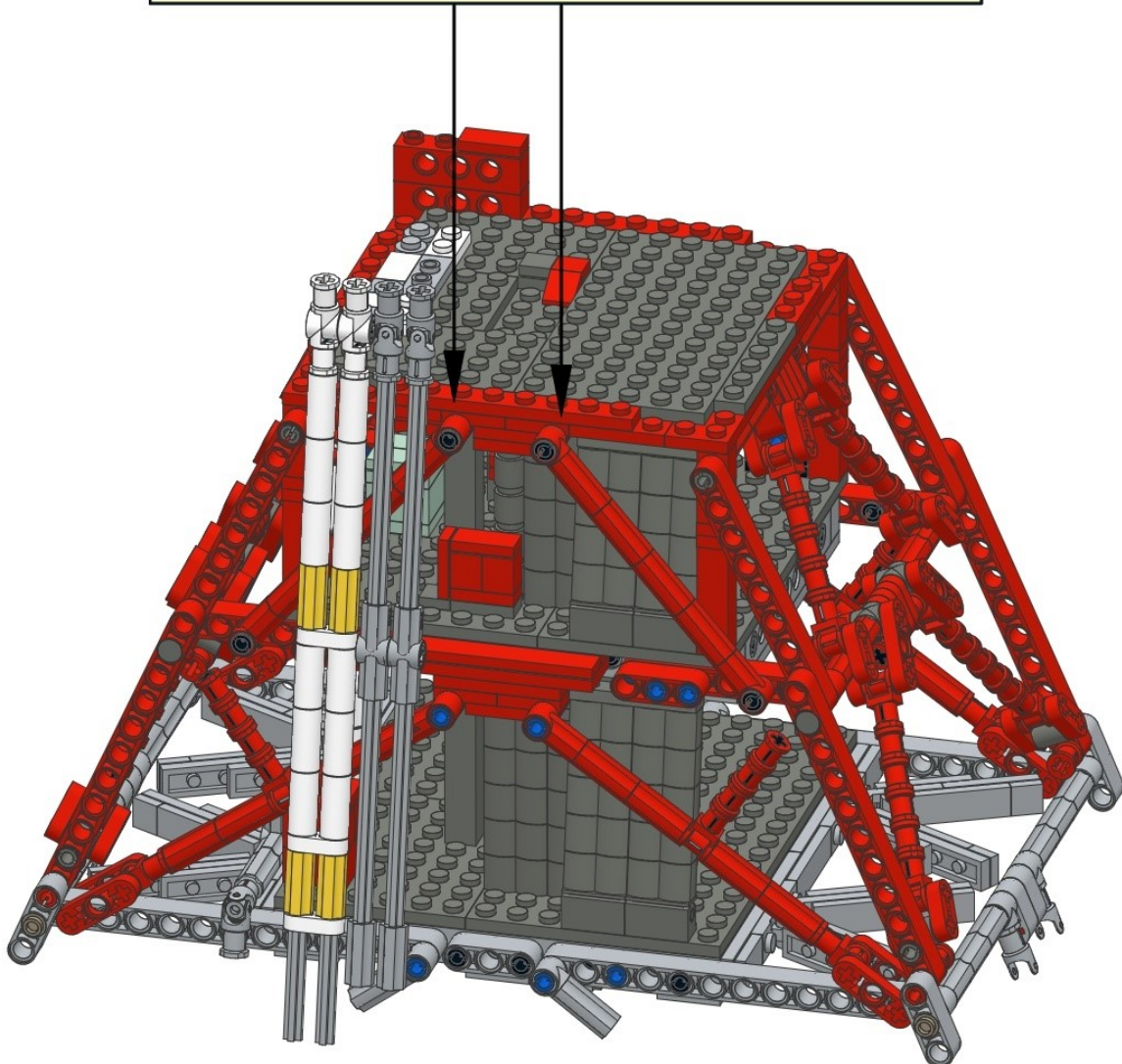
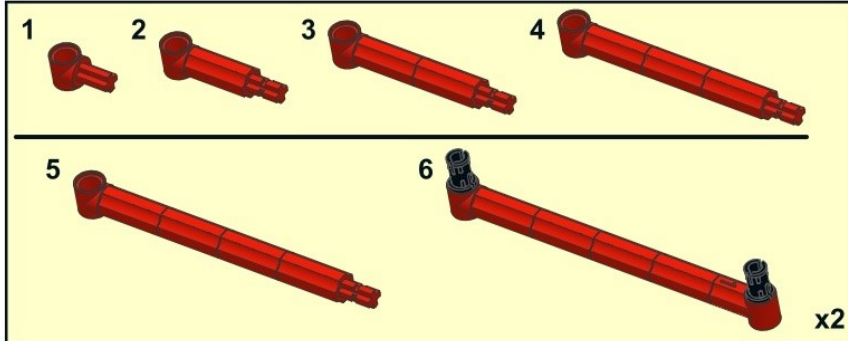

154

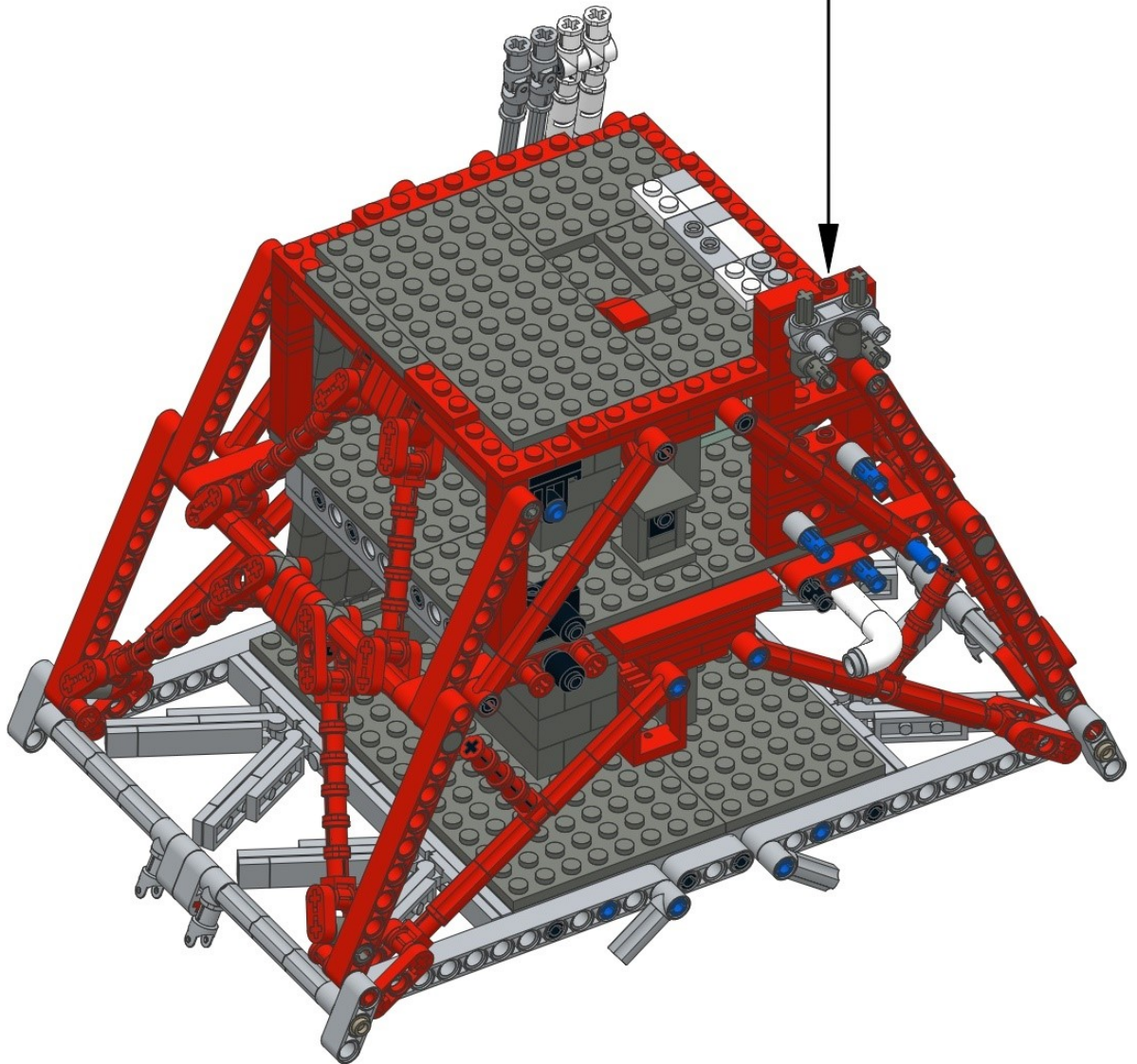
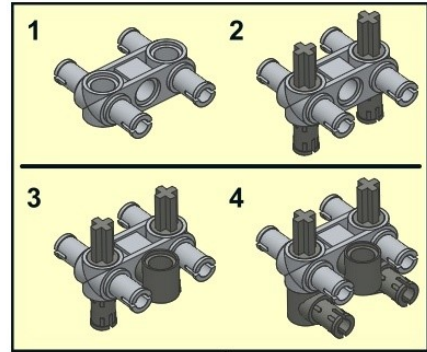
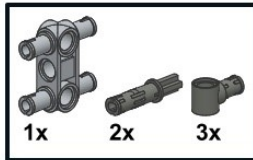



155

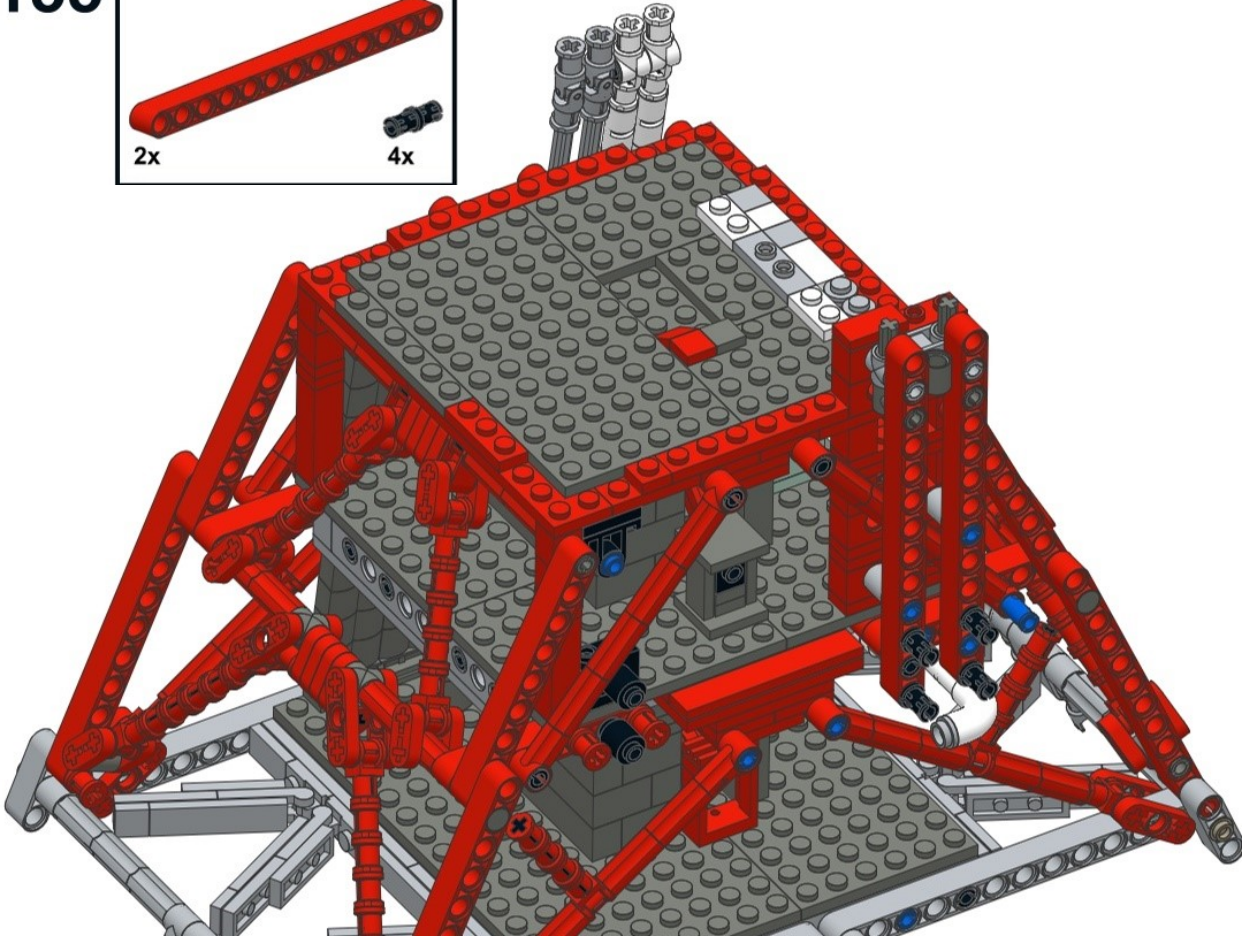
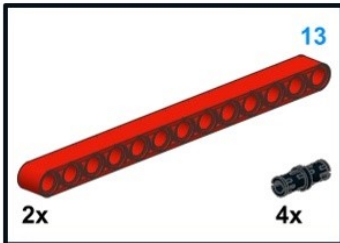

156

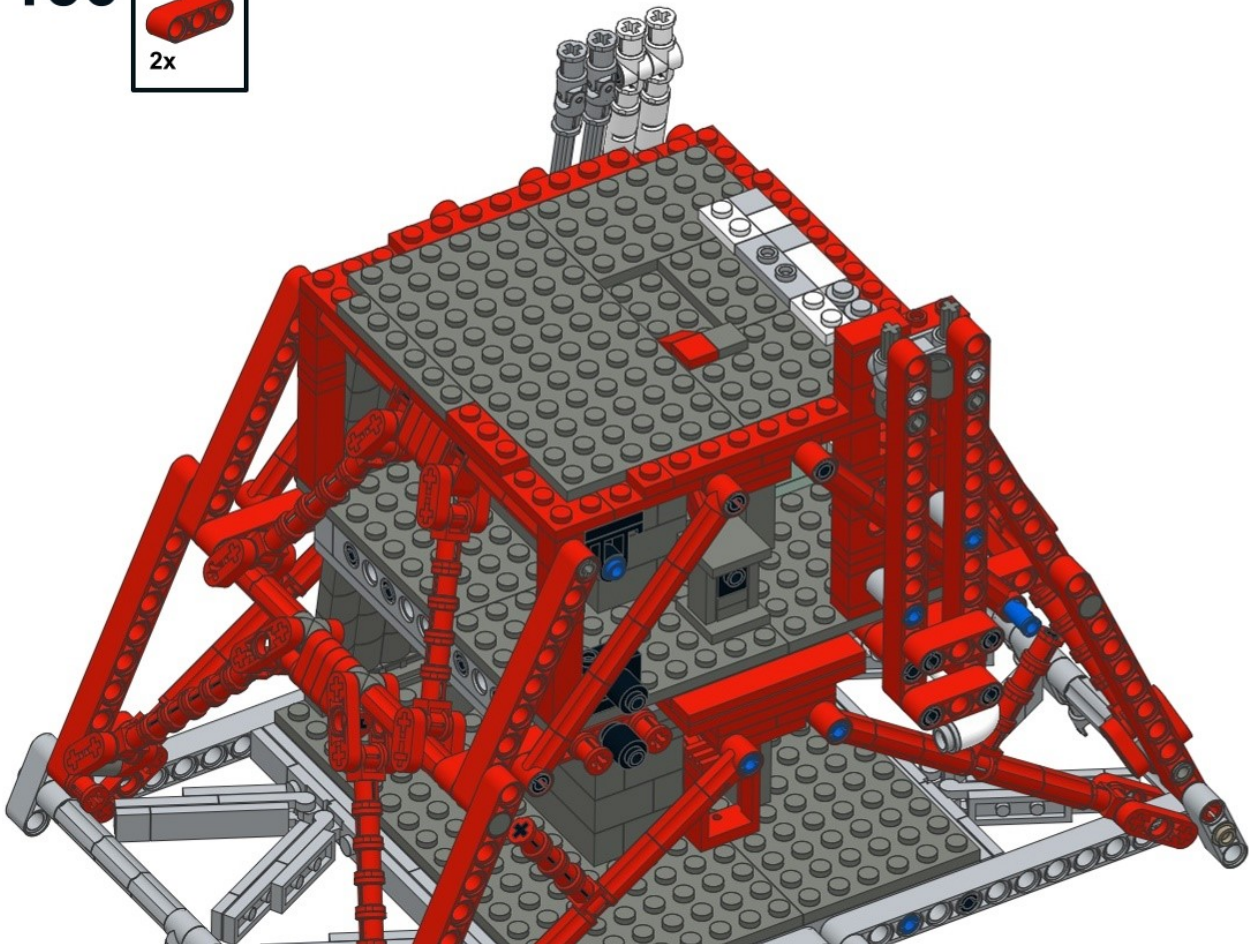



157

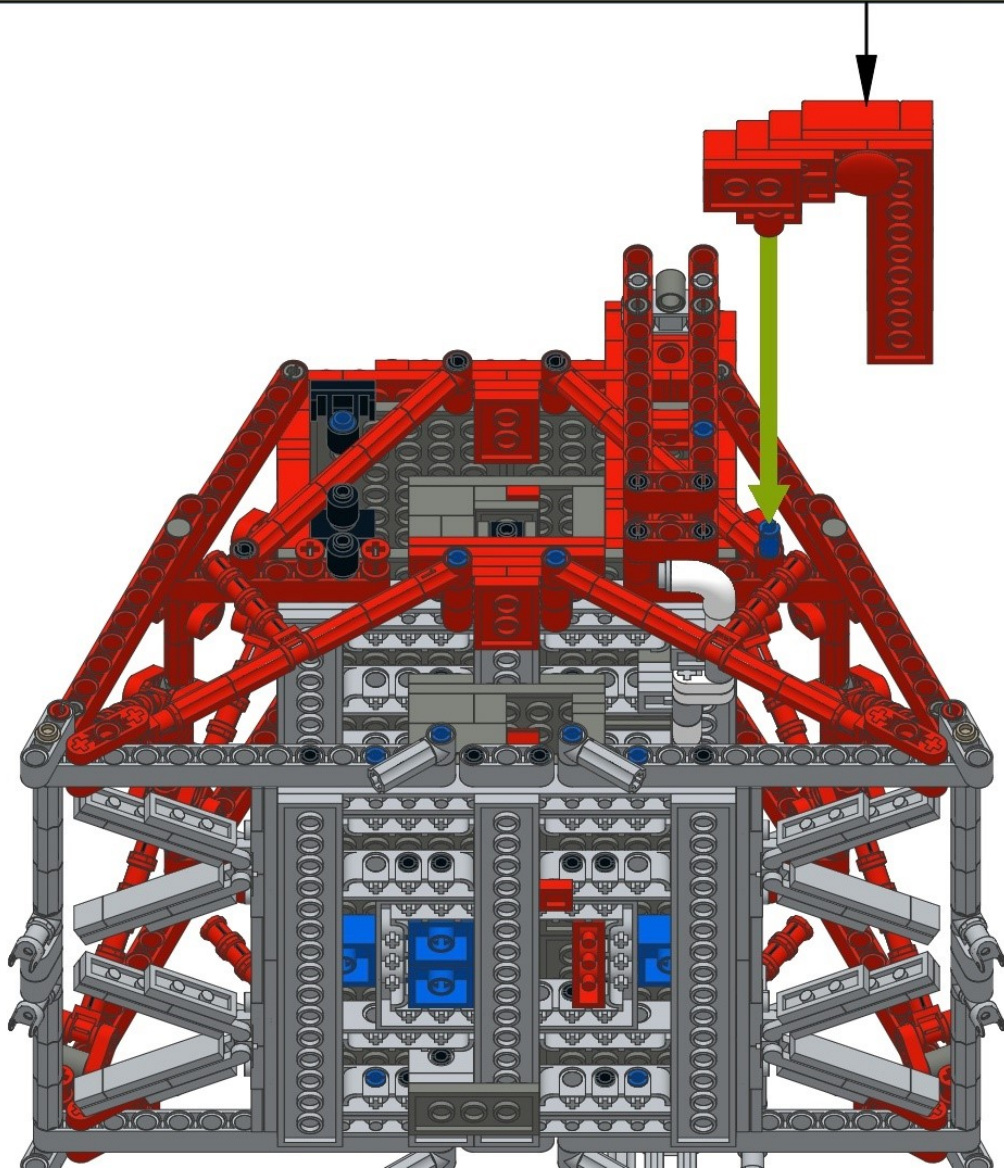
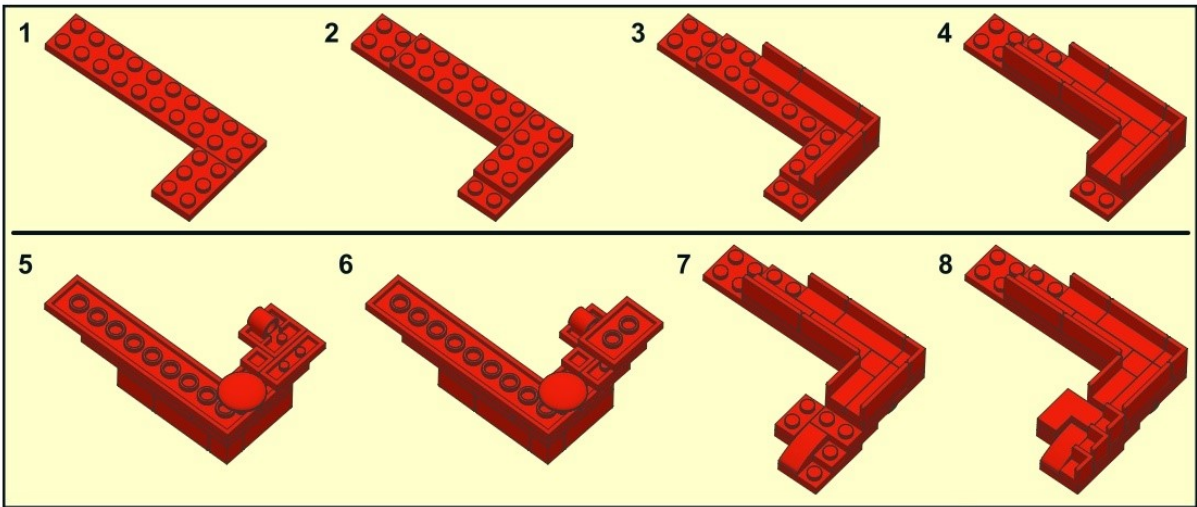
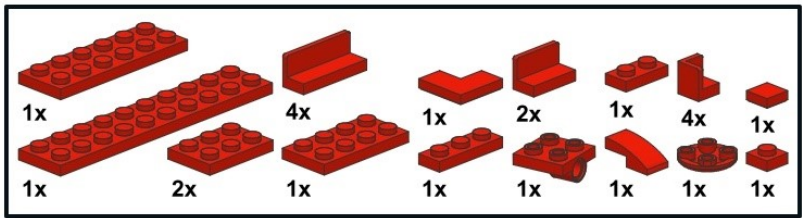



158

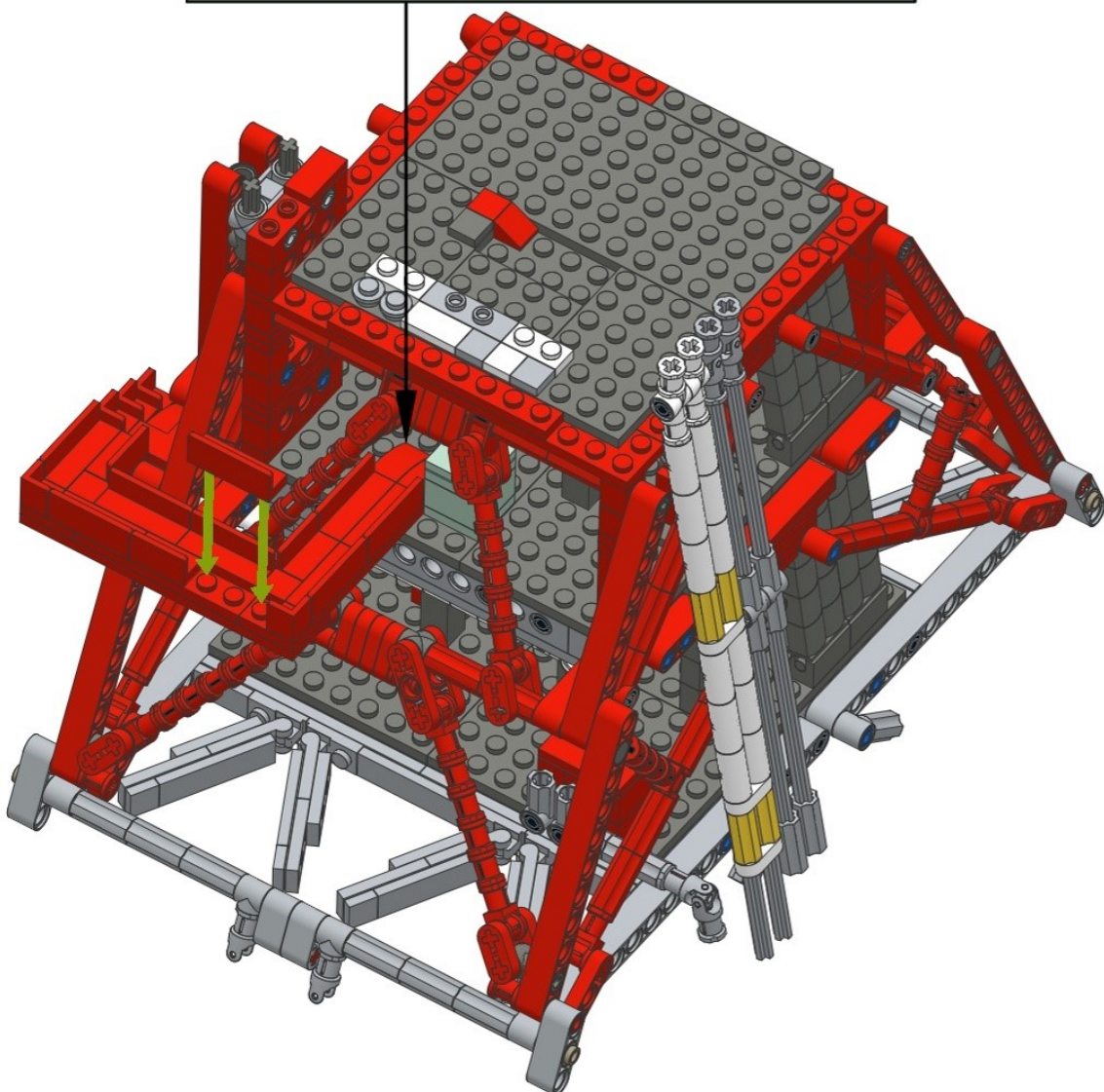
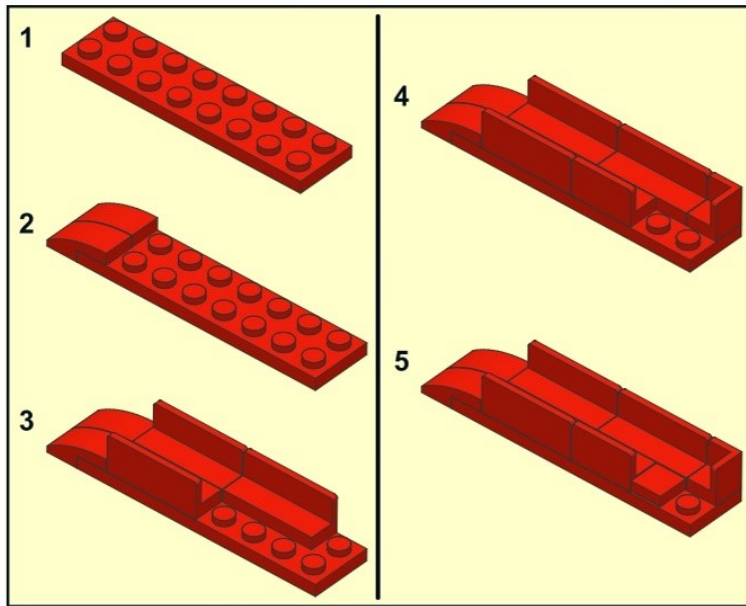
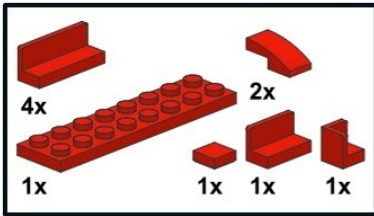

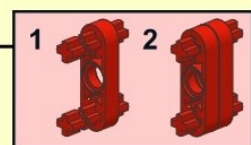
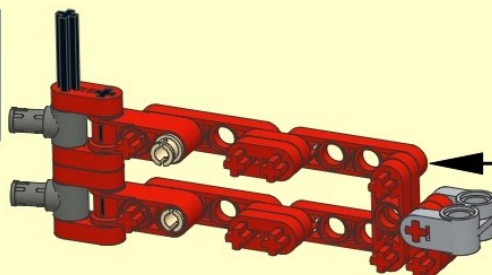
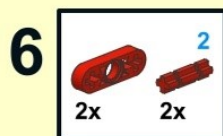
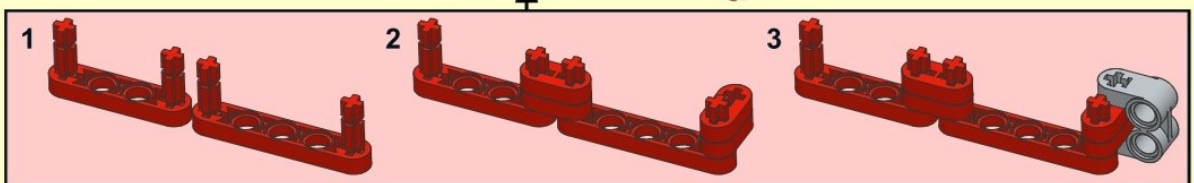
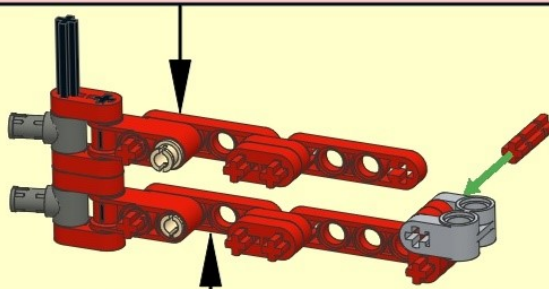
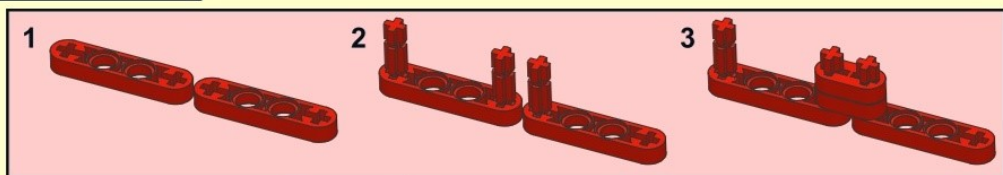
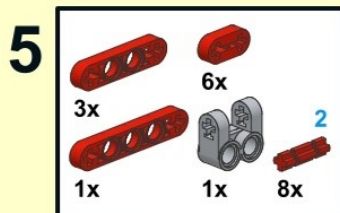
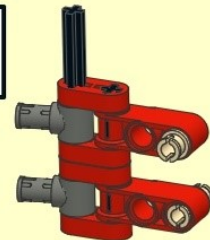
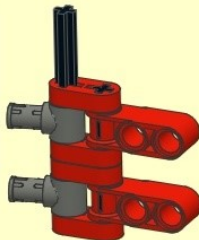
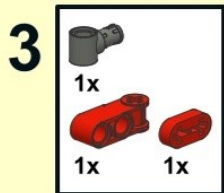
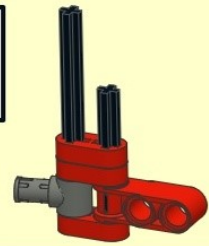
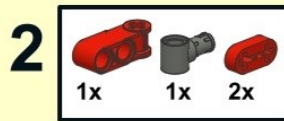



7

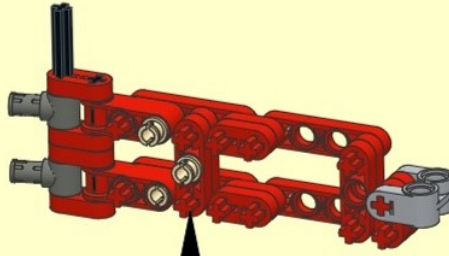
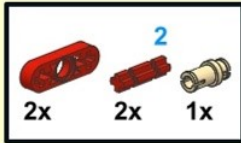

8

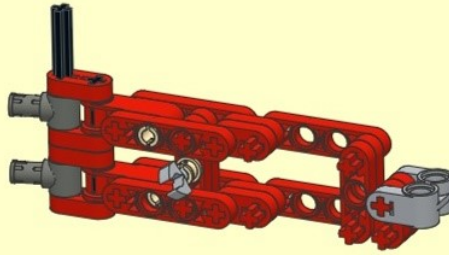
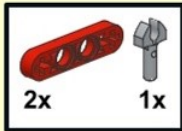

9

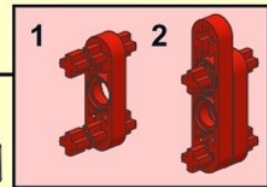
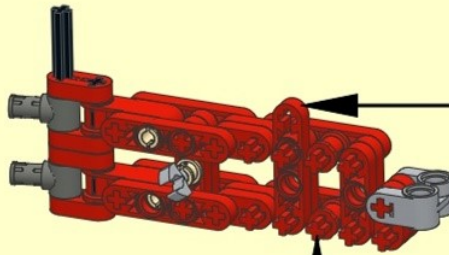
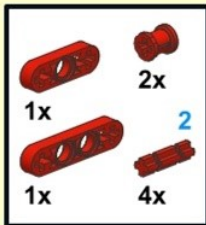

10

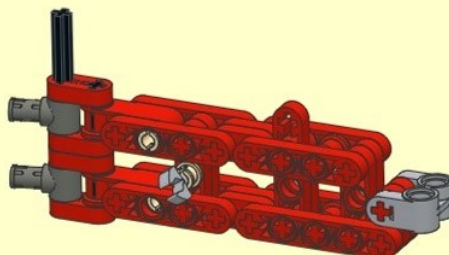
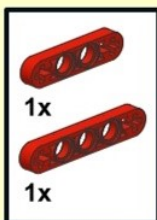

11

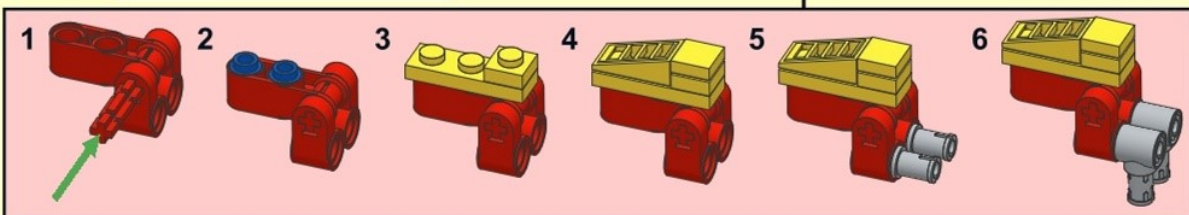
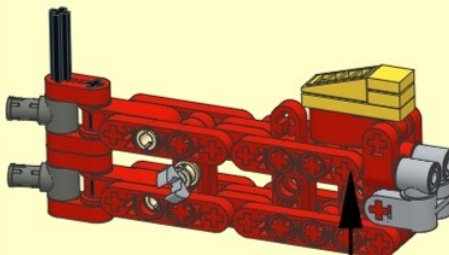
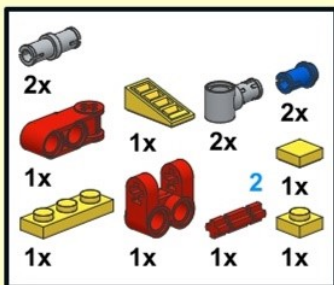

12

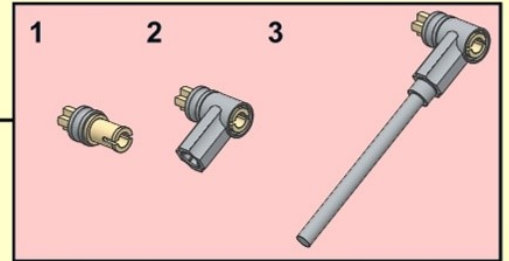
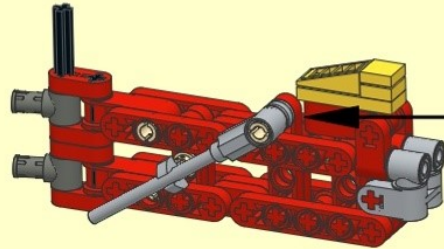
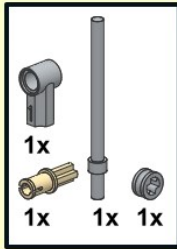

159

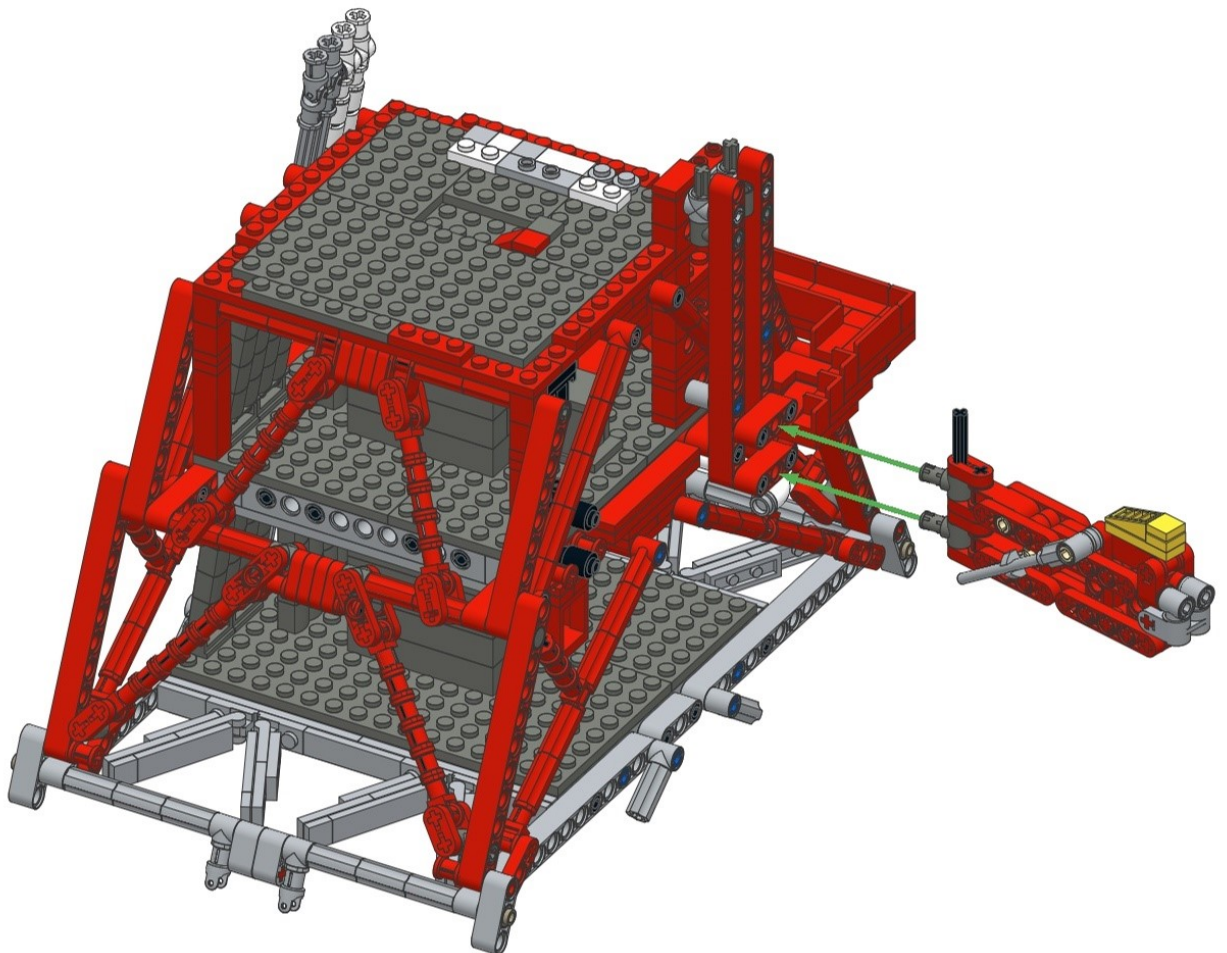



160

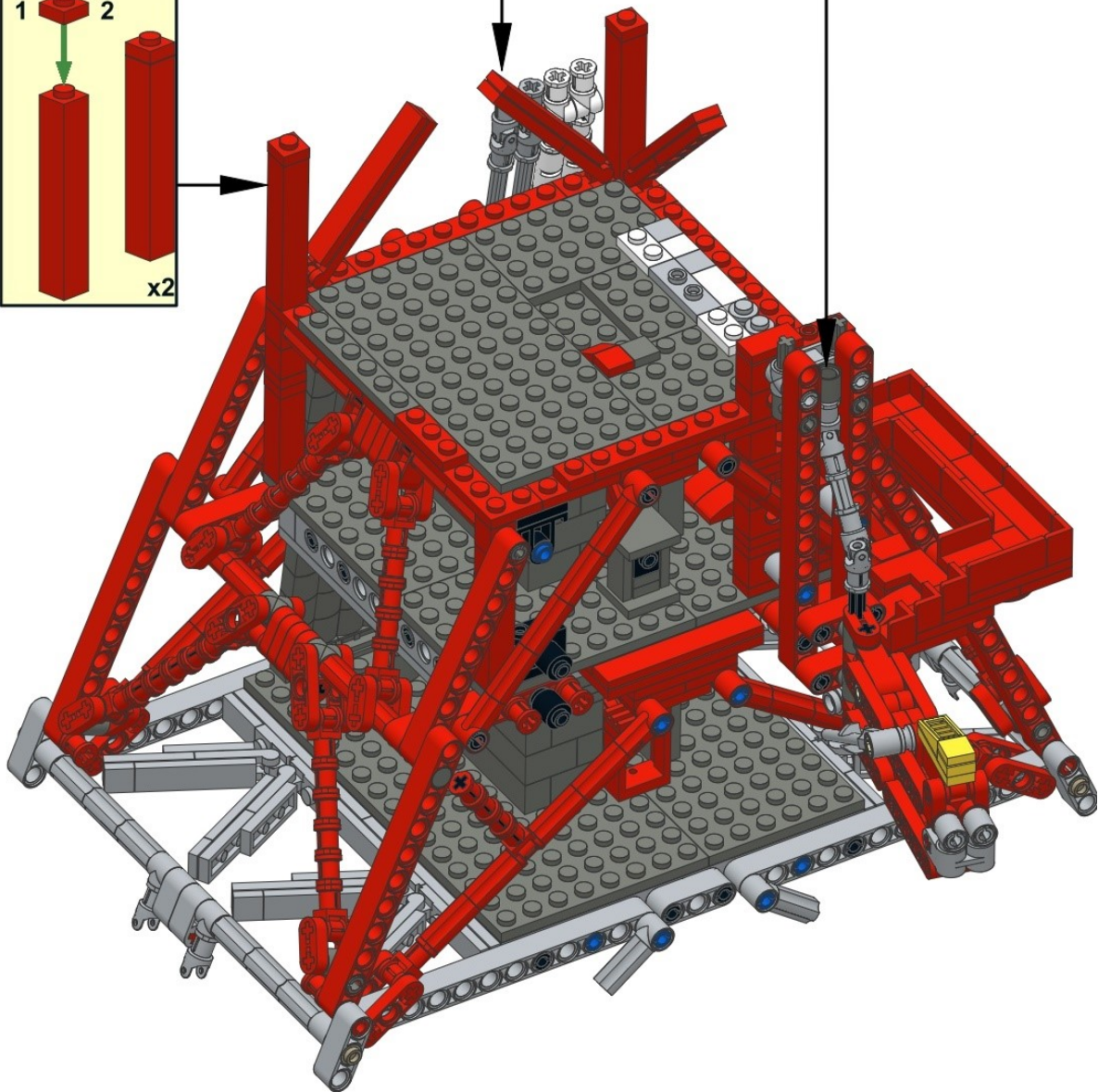
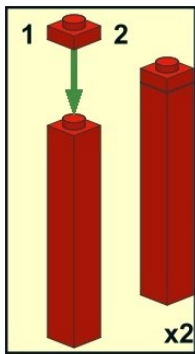
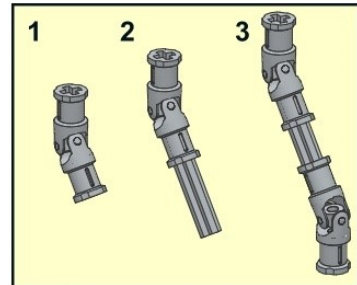
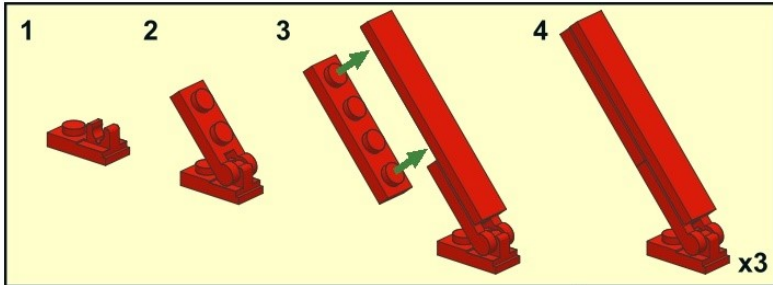
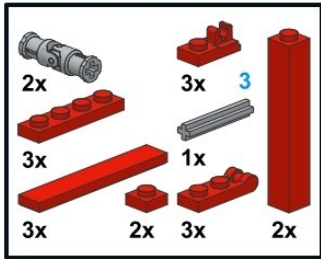

161

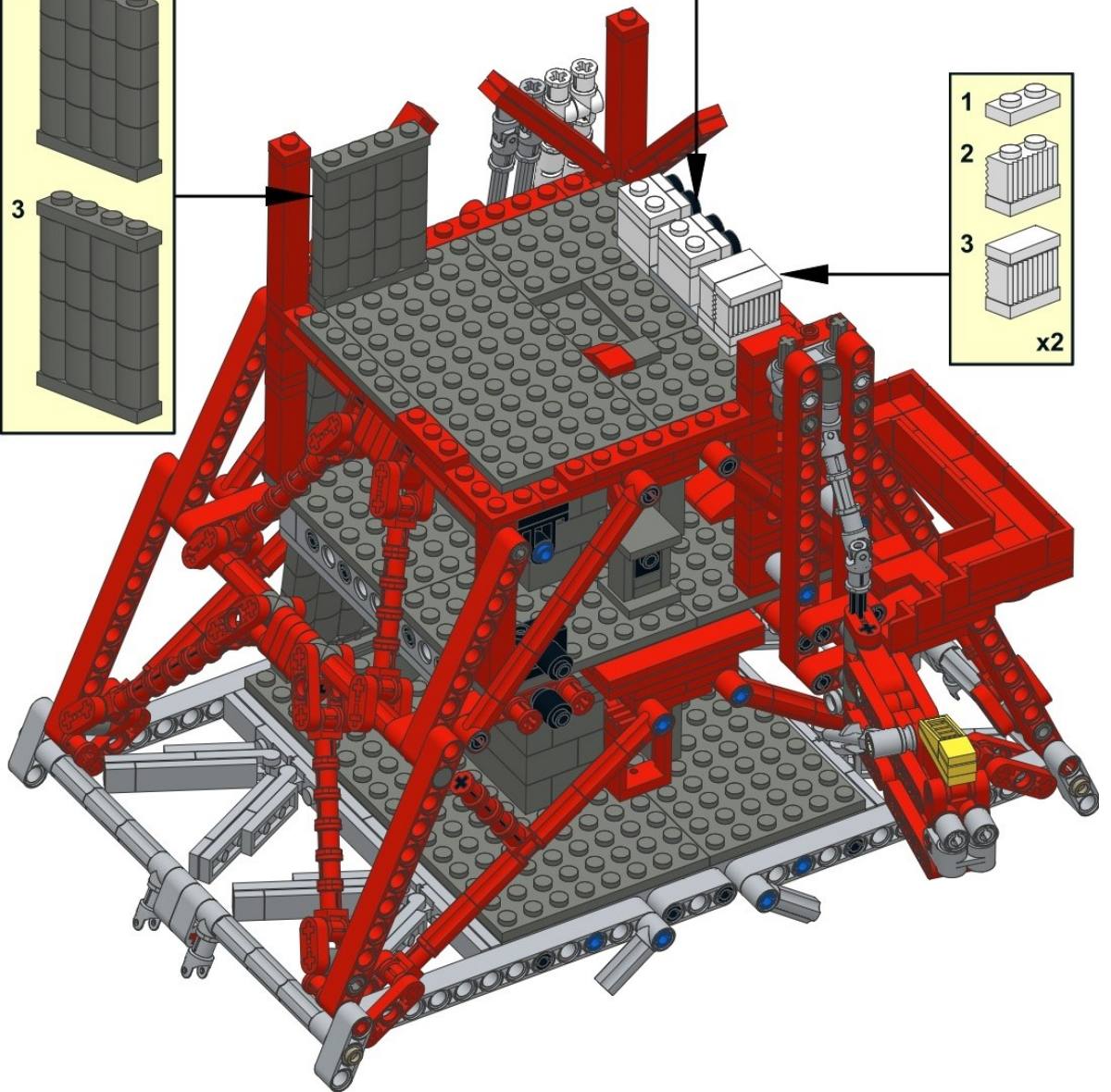
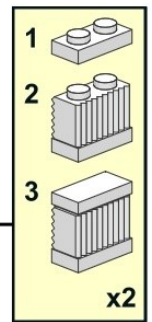
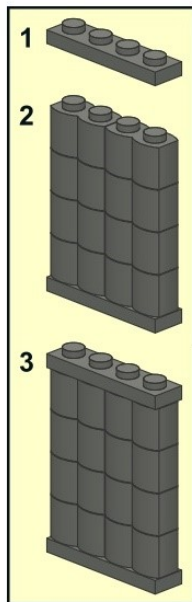
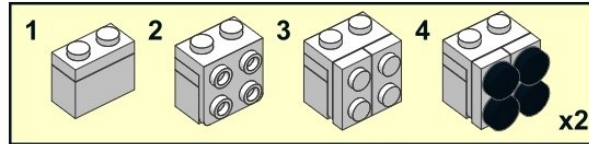
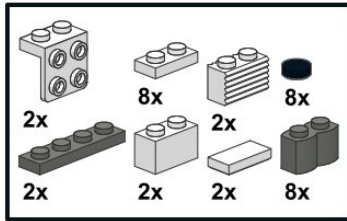



162

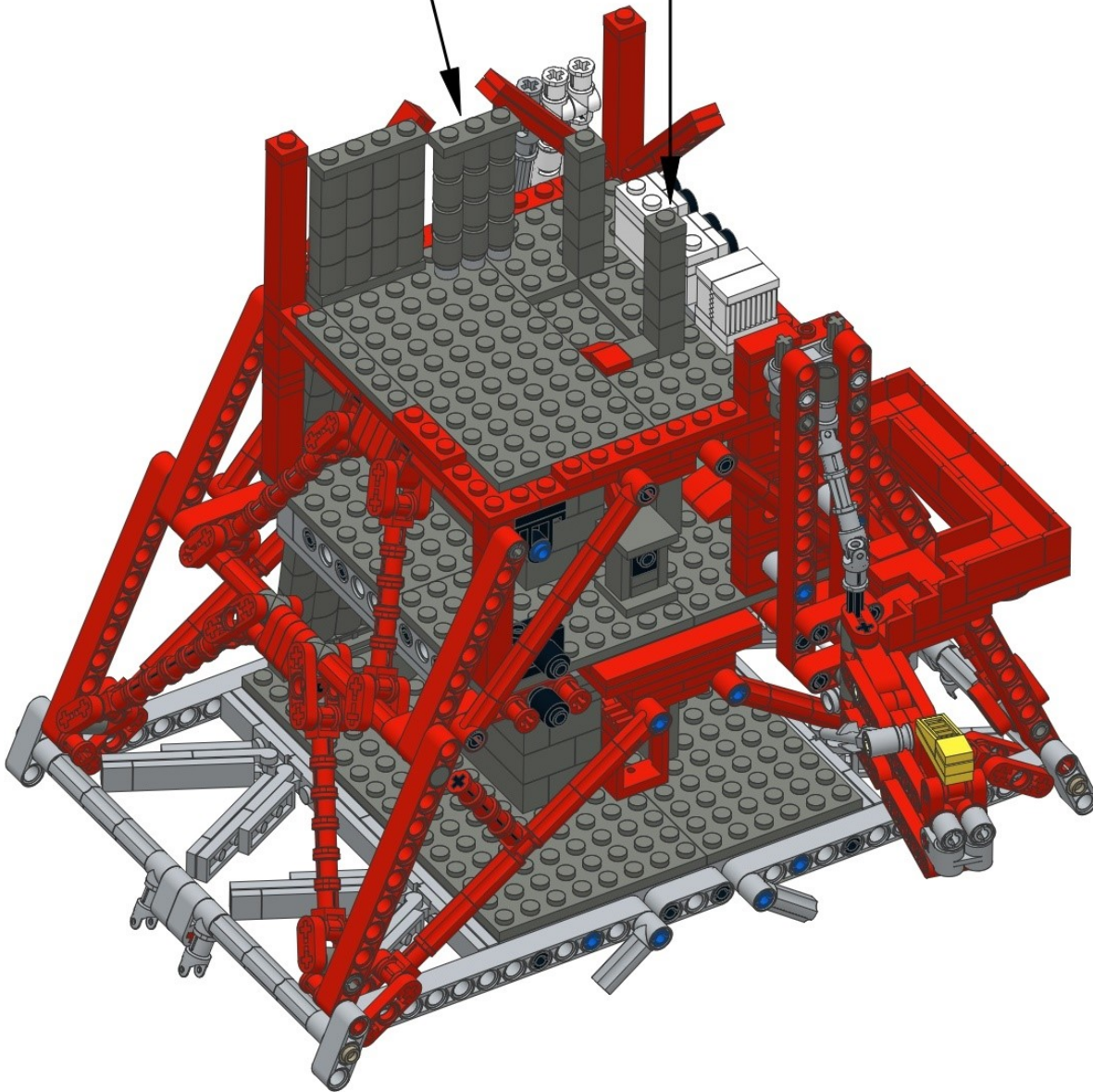
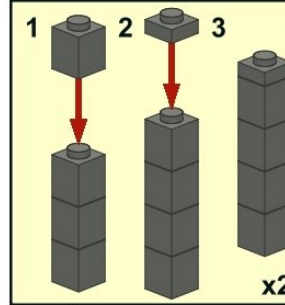
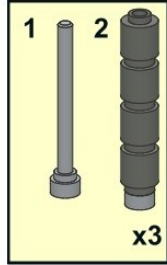
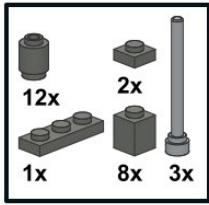

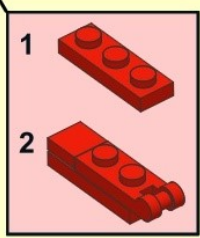
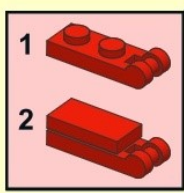
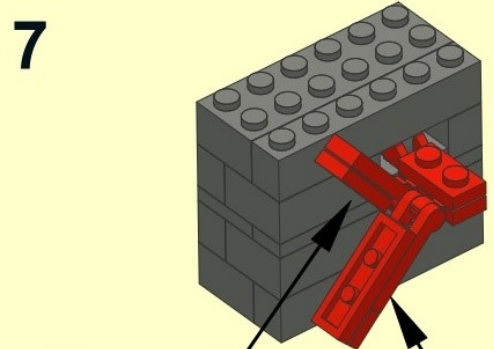
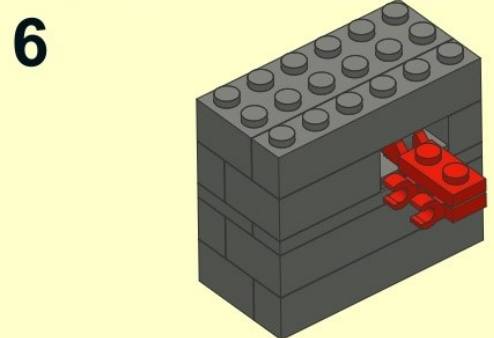
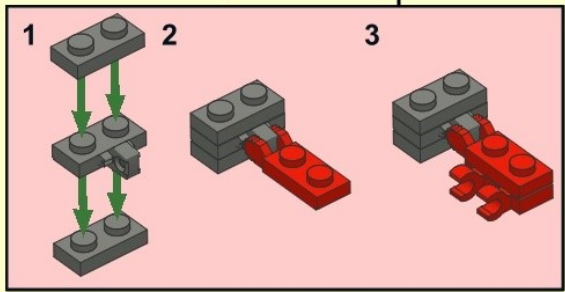
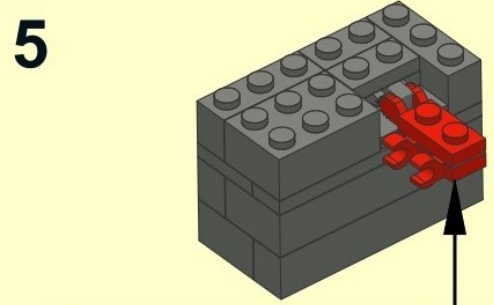
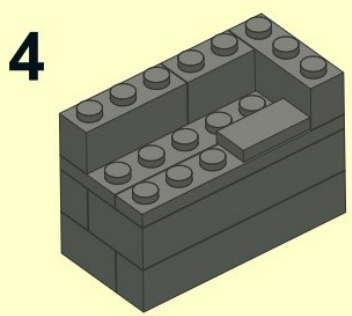
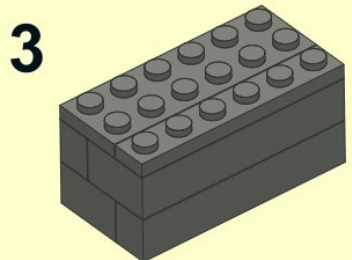
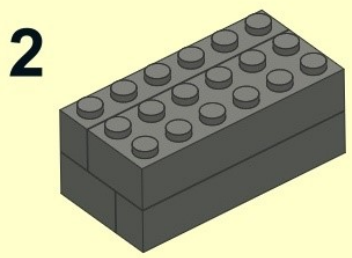
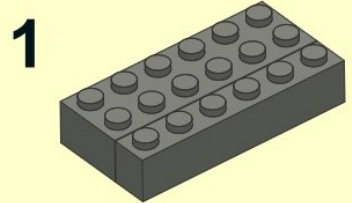
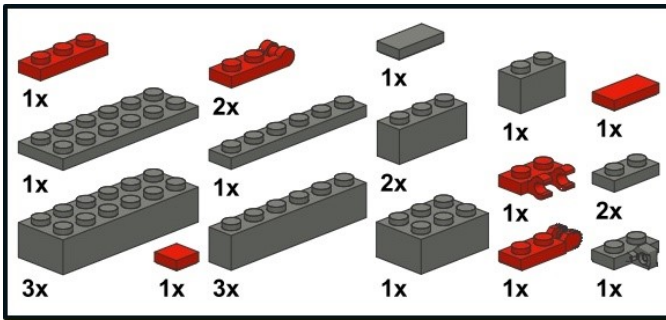



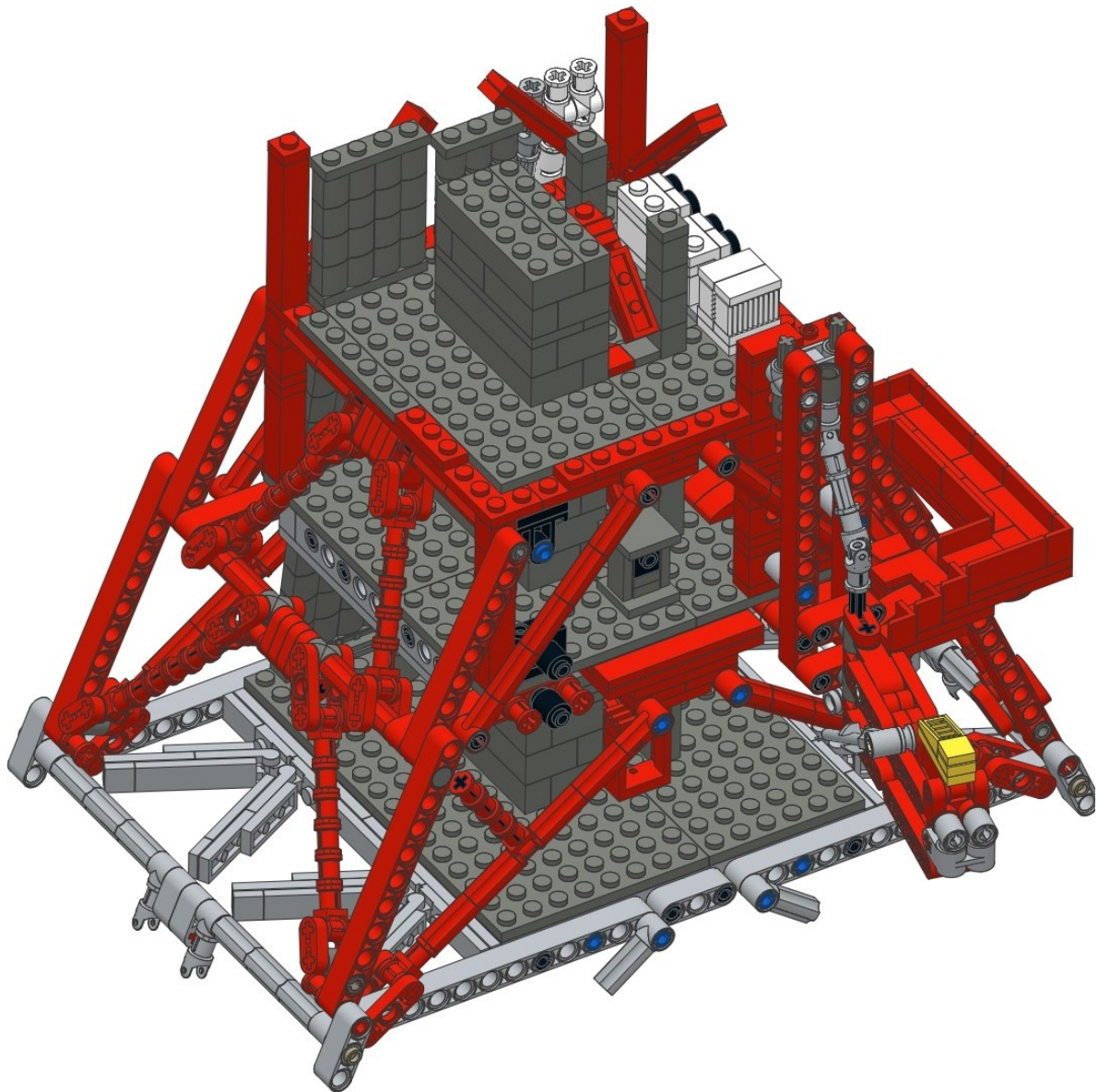

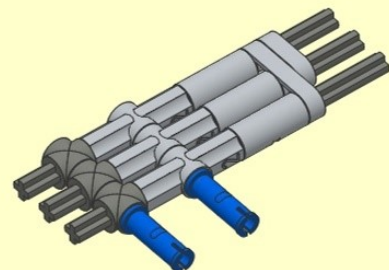
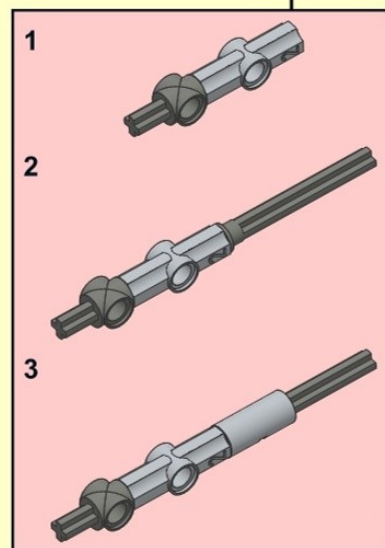
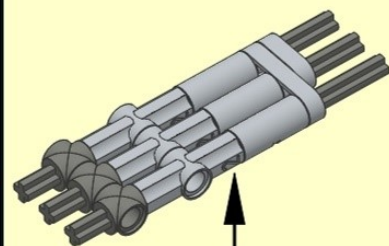
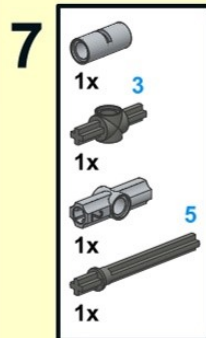
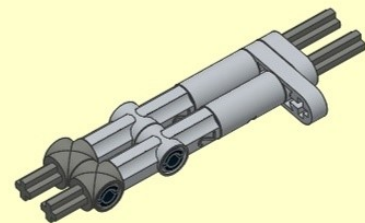
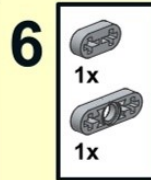
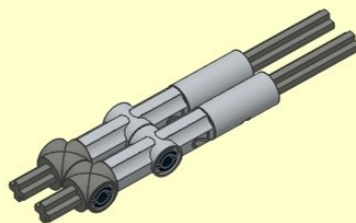
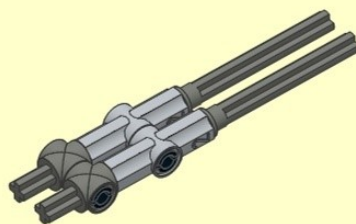
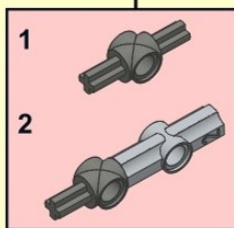
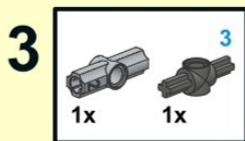
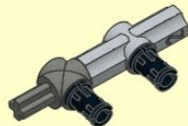
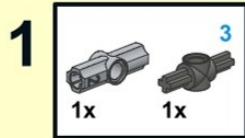



9

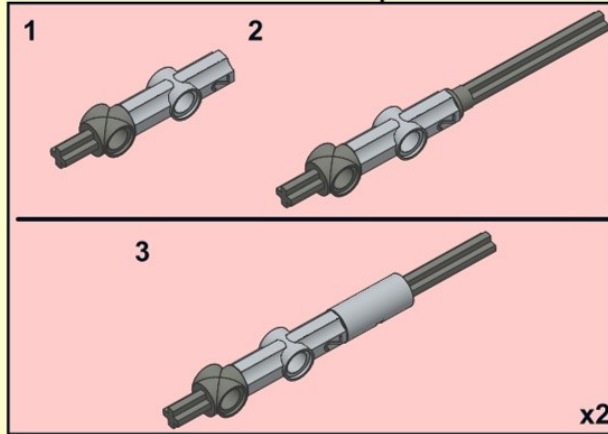
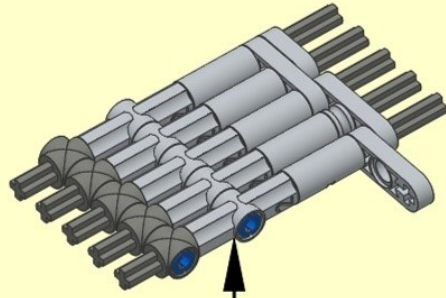
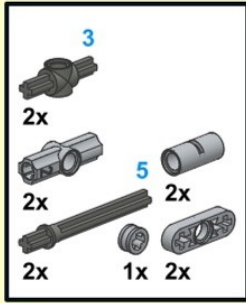

10

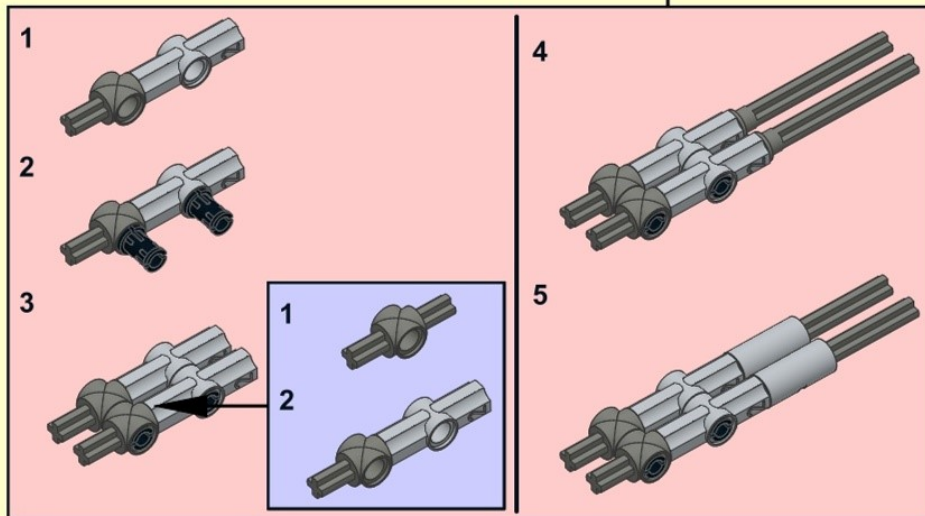
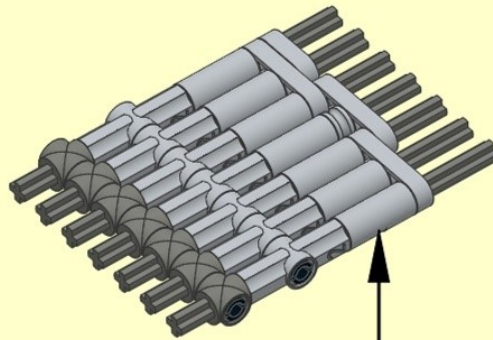
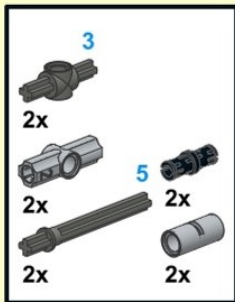

11  1x

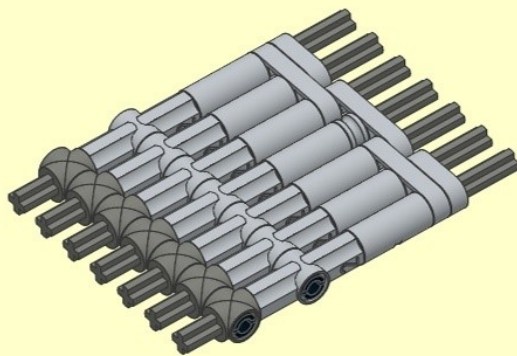

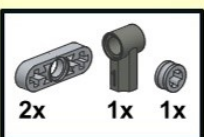
12  2x 1x 1x

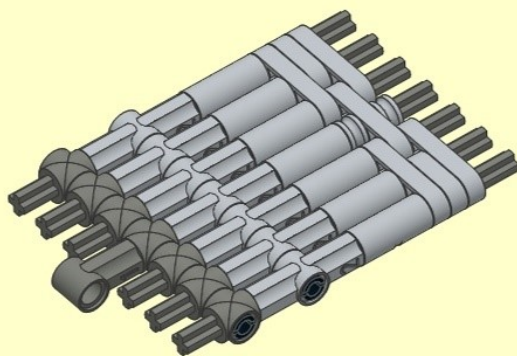

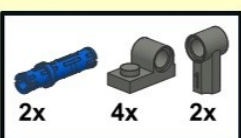
13  2x 4x 2x

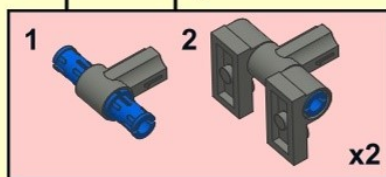
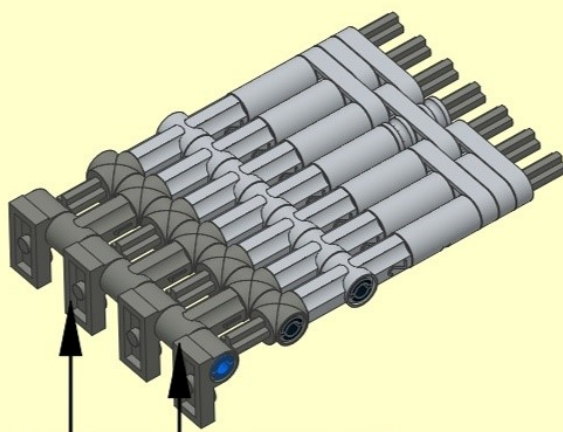

14  7x 2x

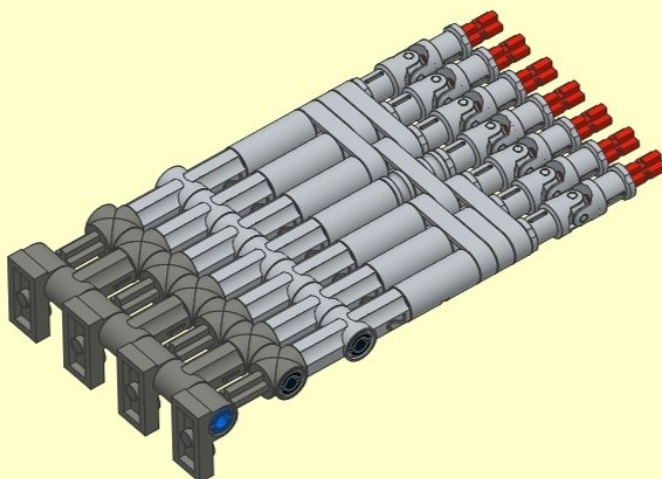



15

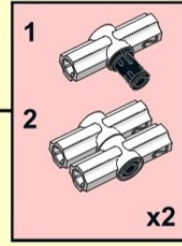
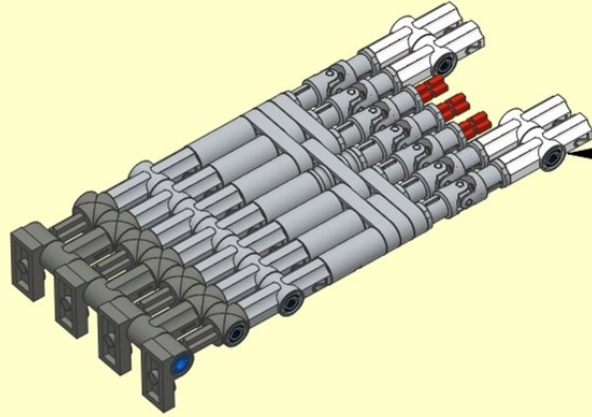
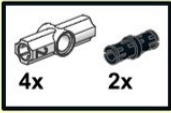

16

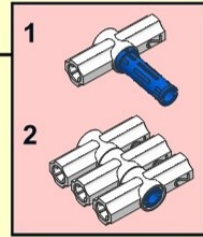
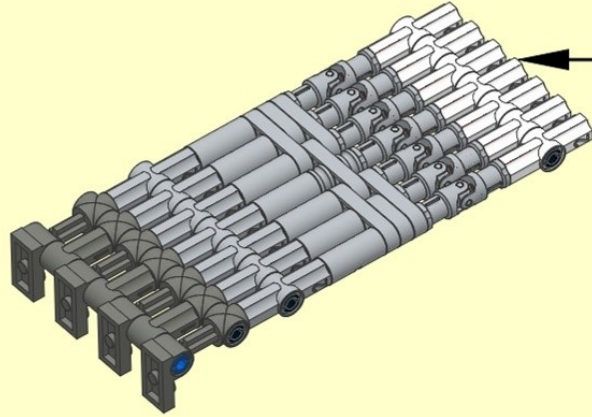
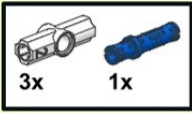

17

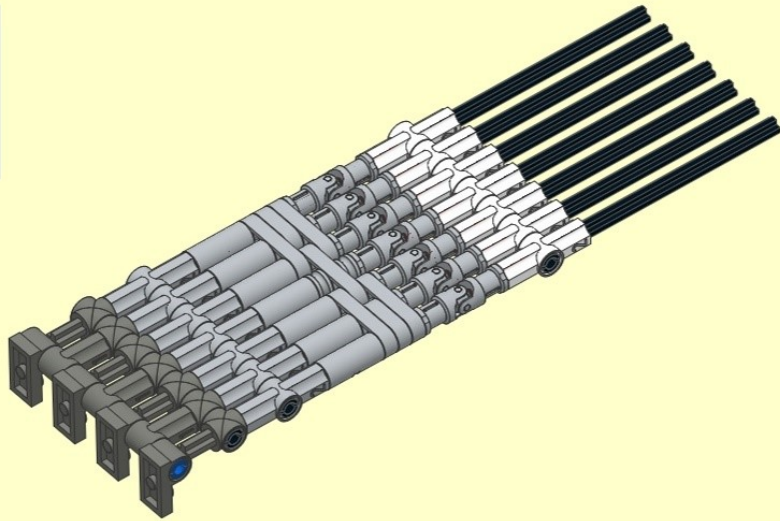

18

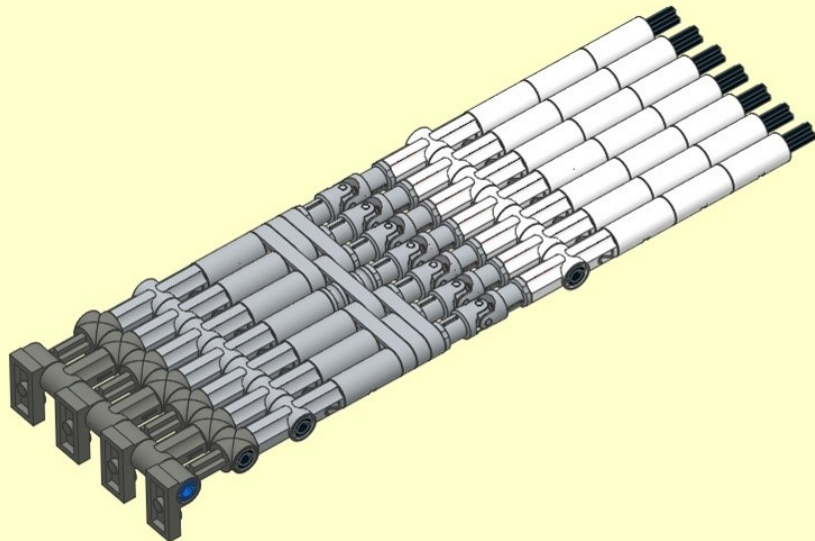

19

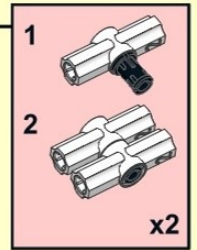
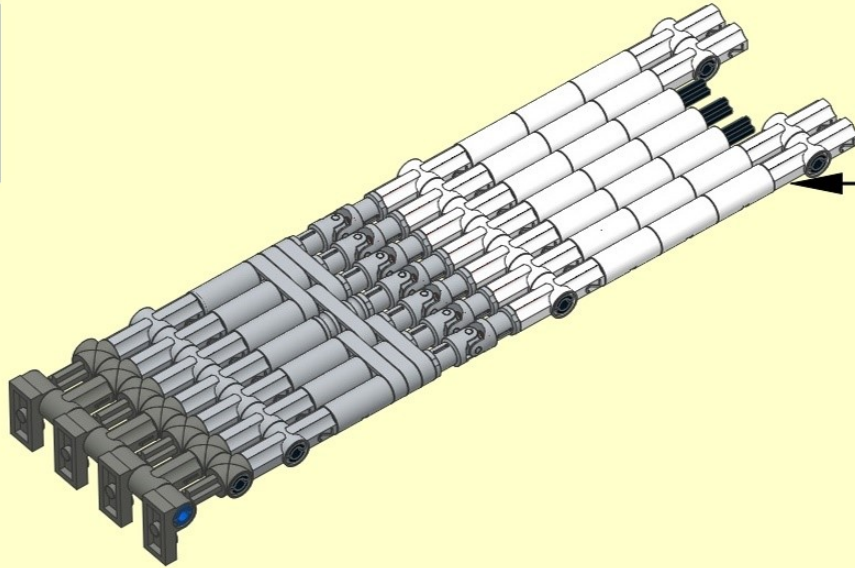
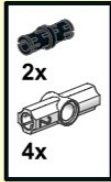

20

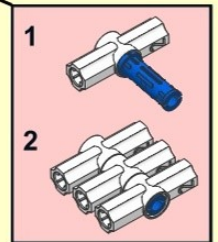
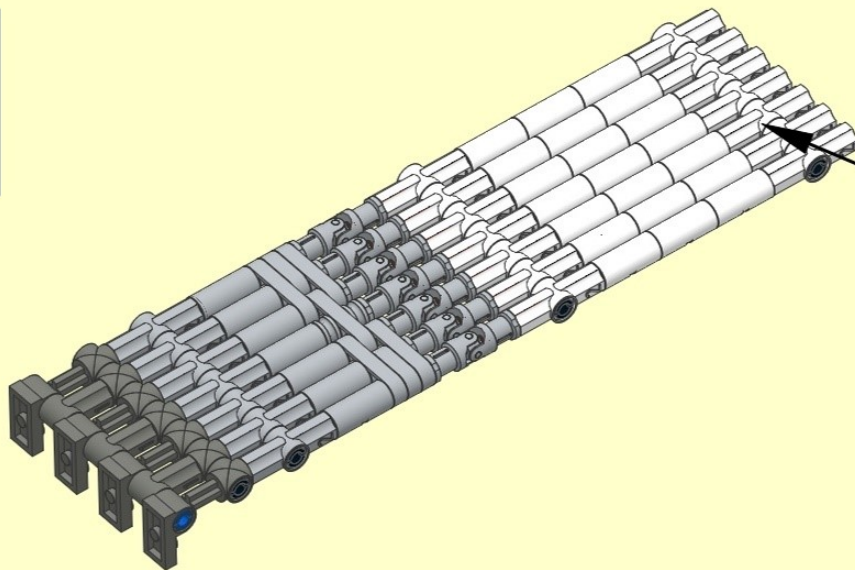
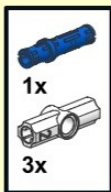

21

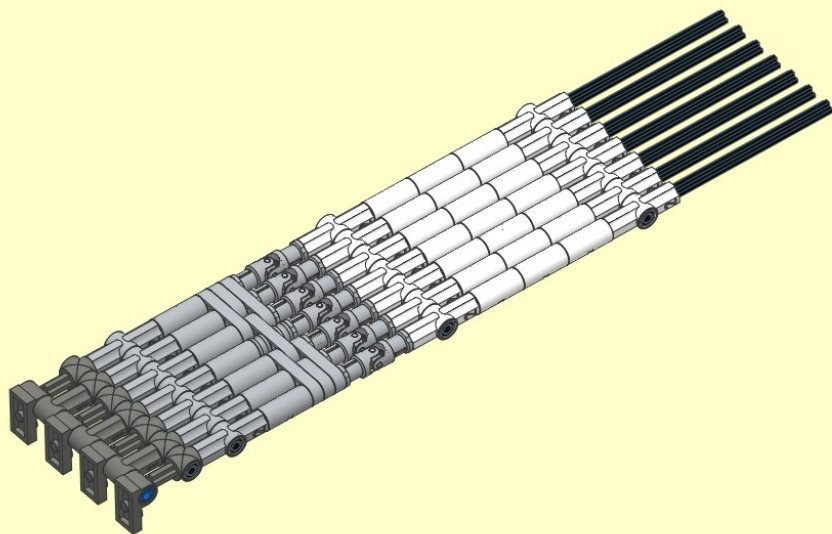



22

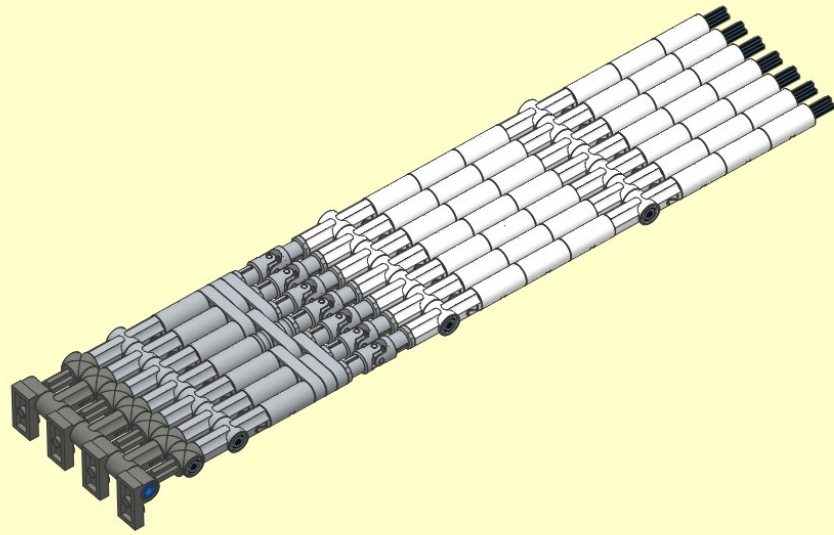

23

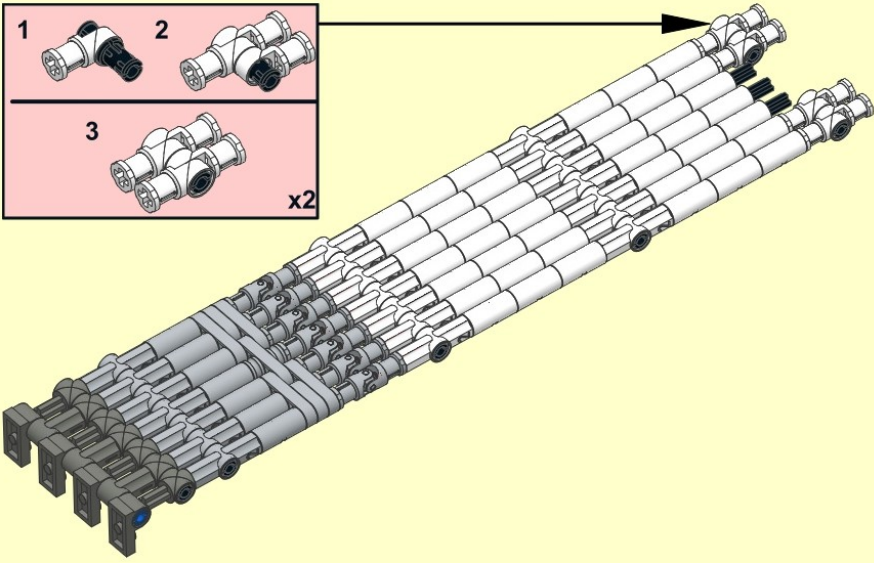
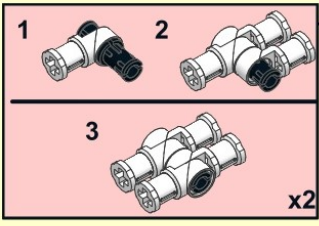
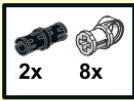

24

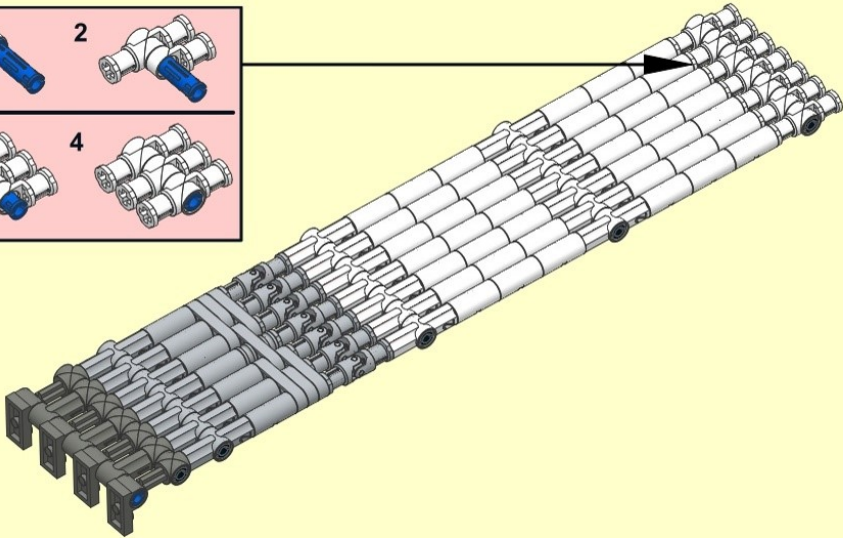
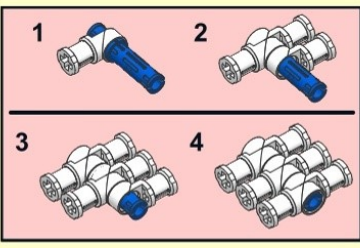

25

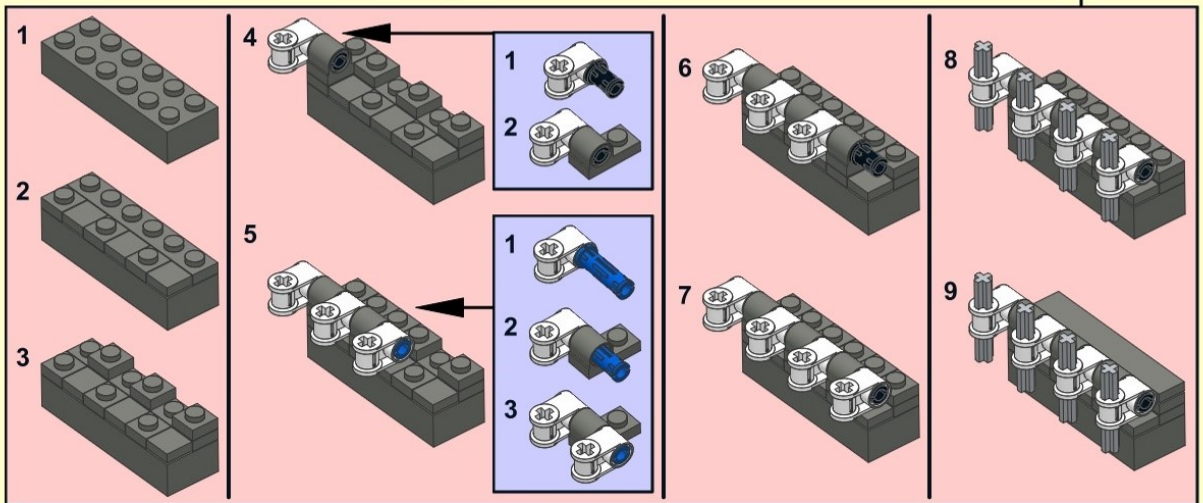
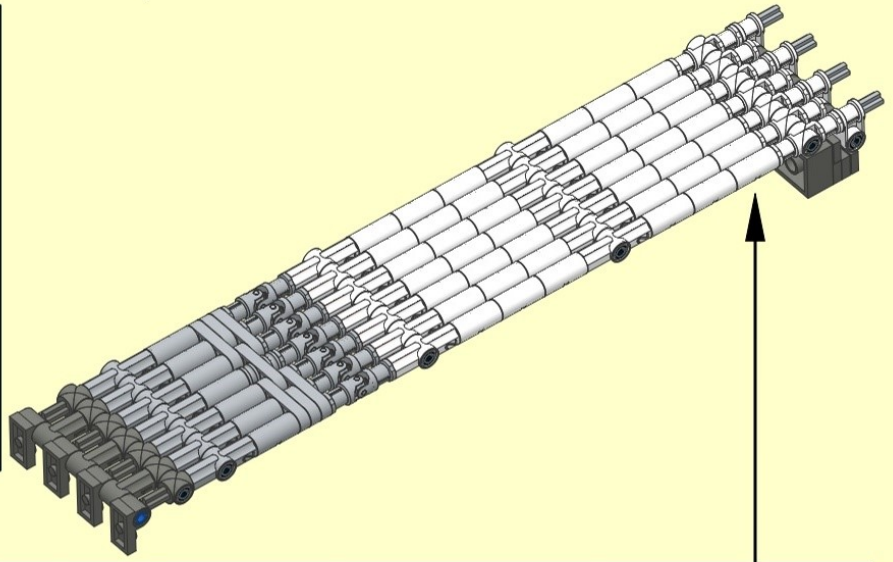
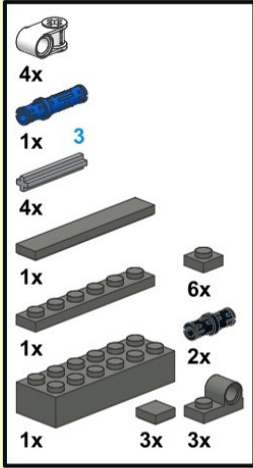

26

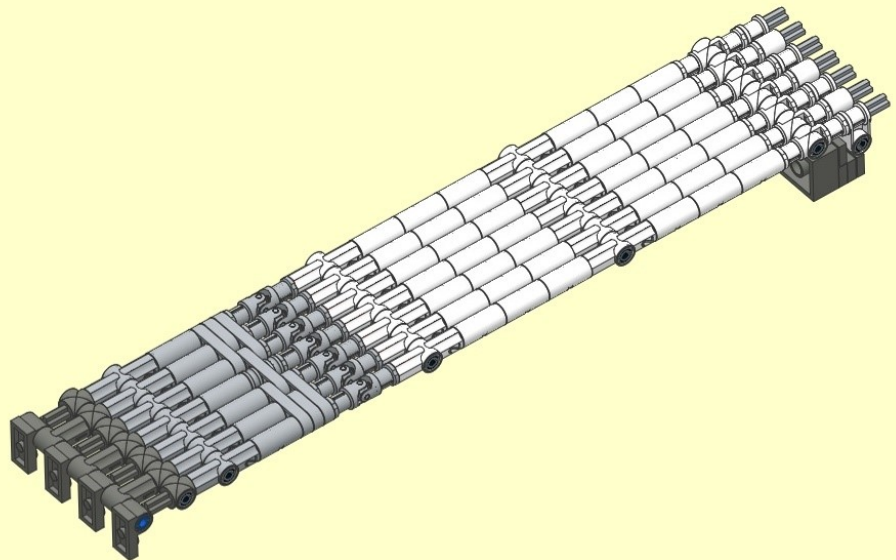
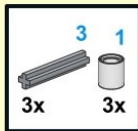



27

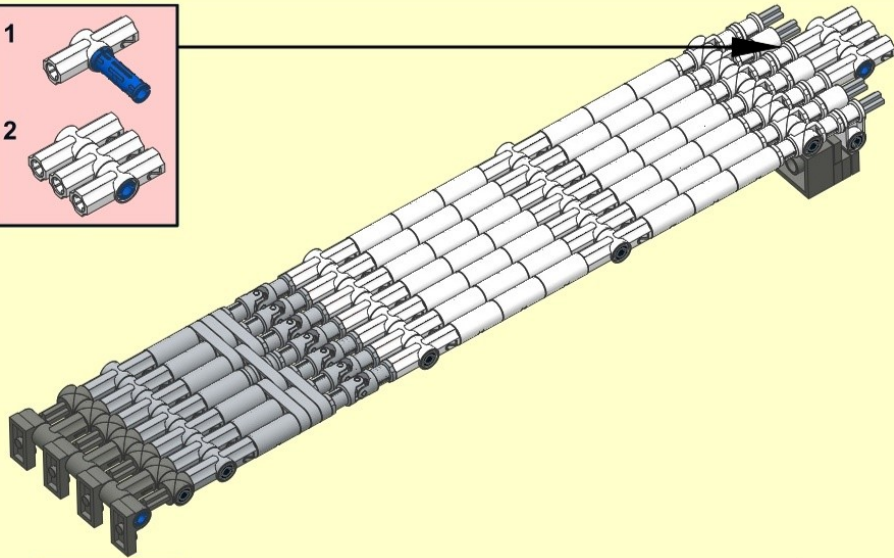
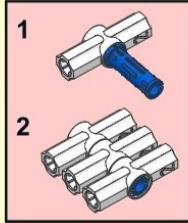
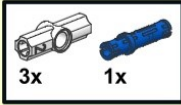

28

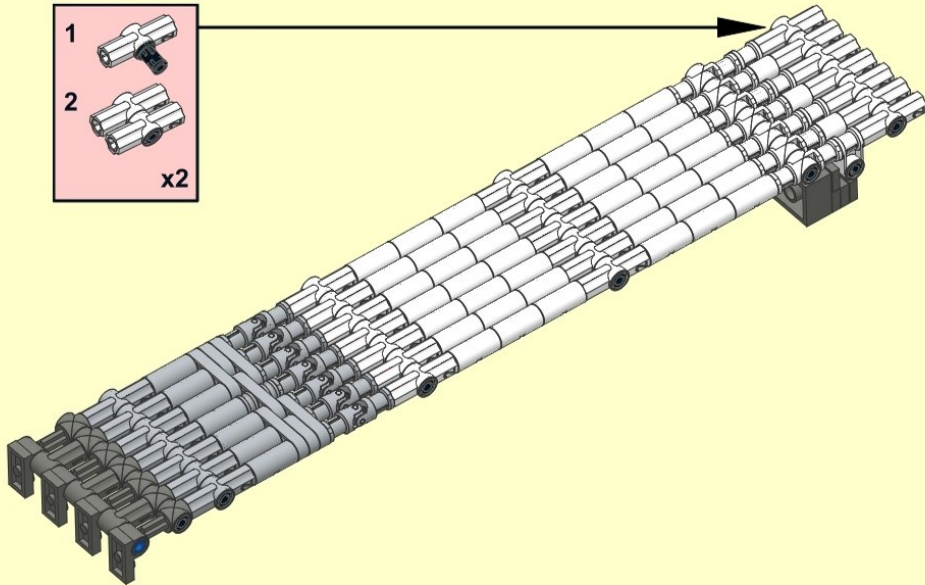
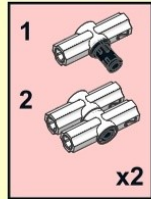
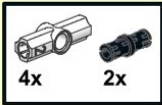

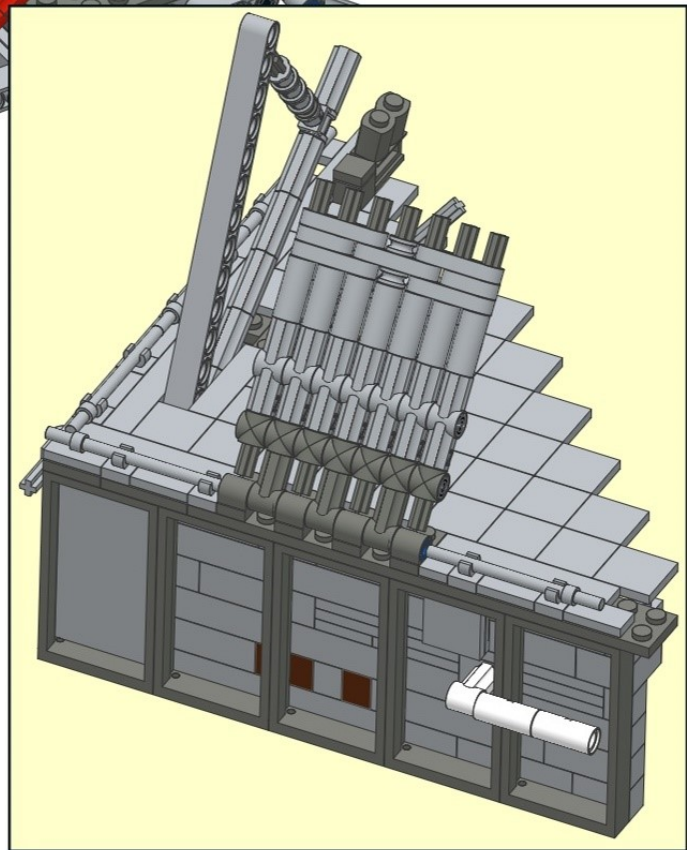
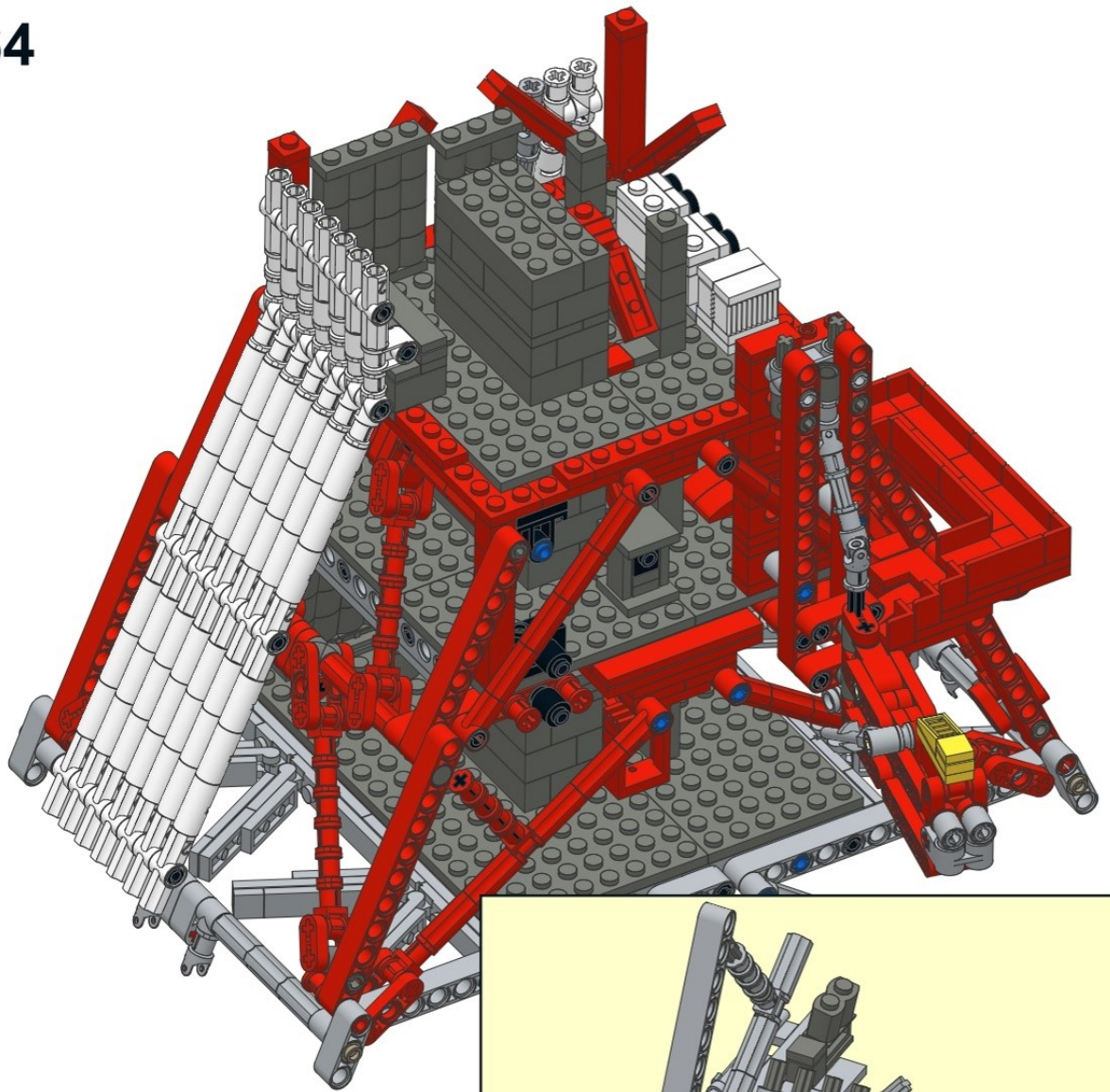



165

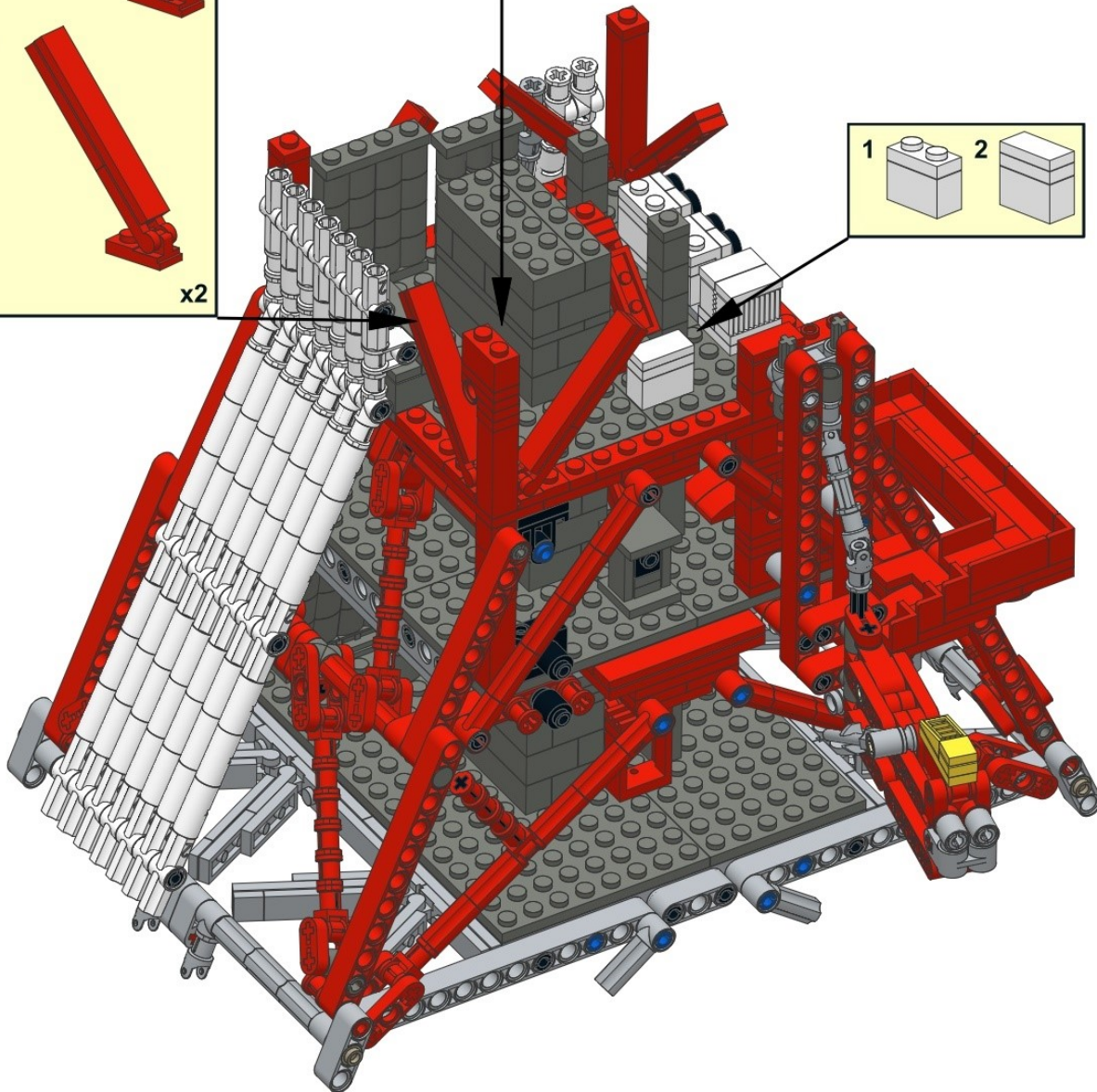
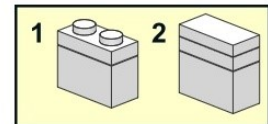
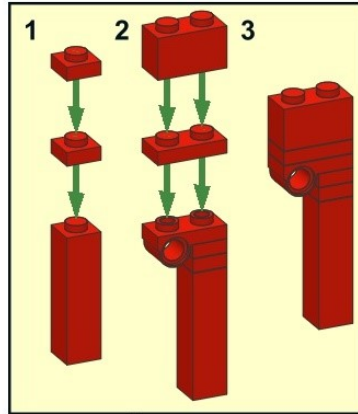
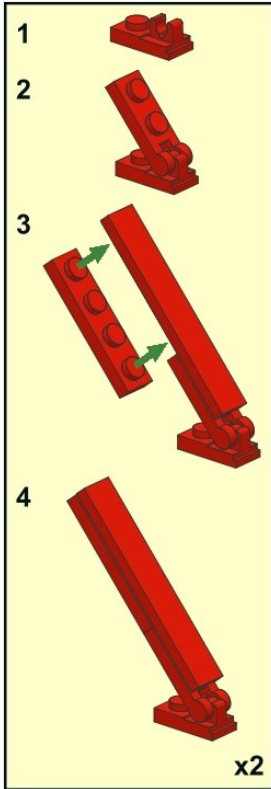
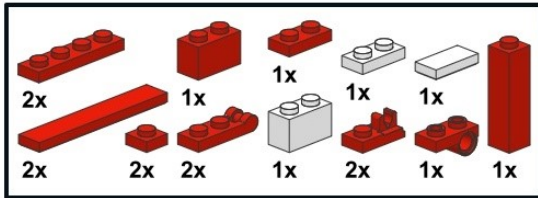

166

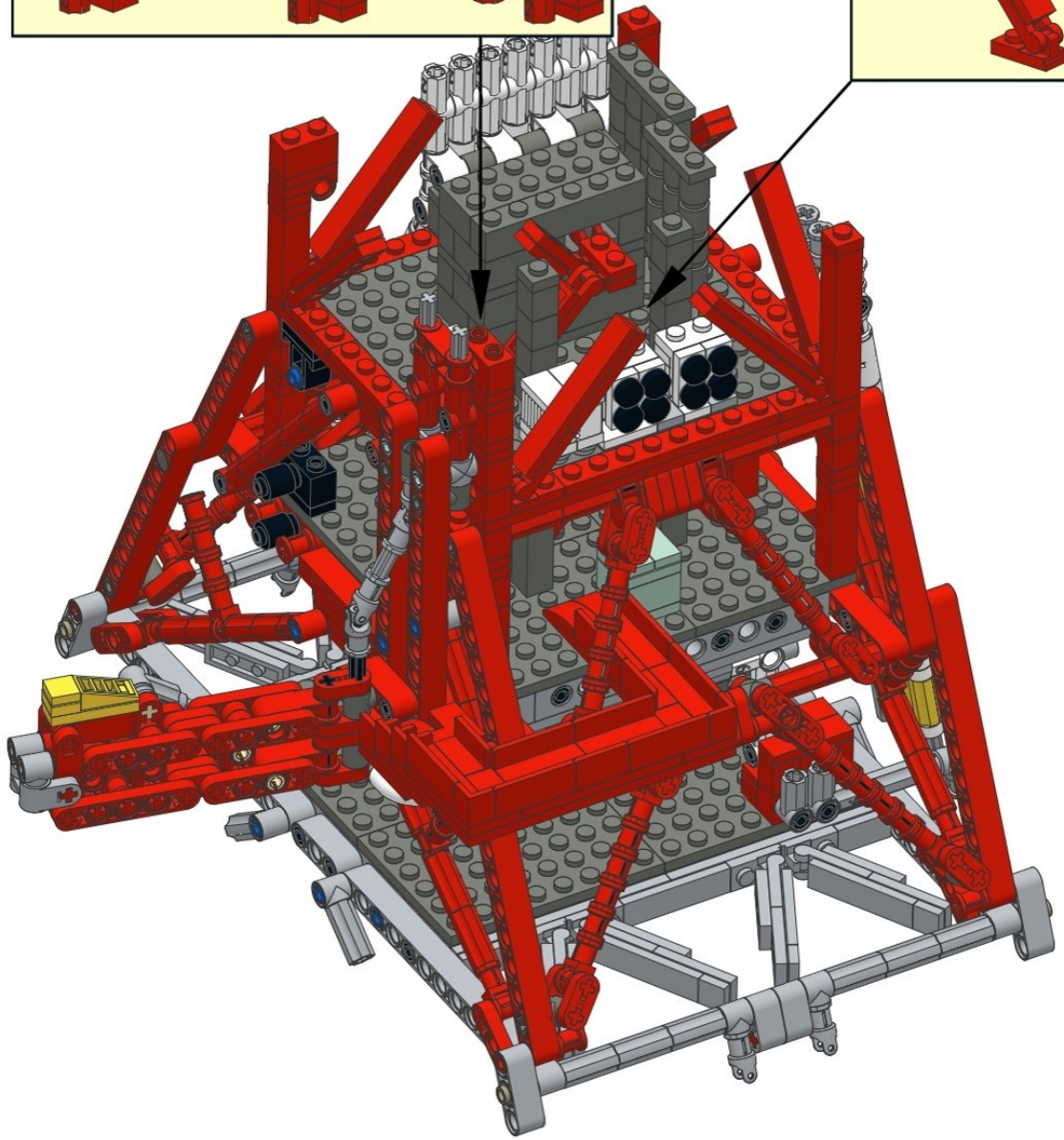
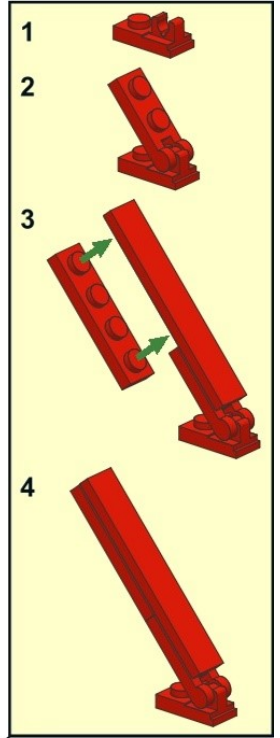
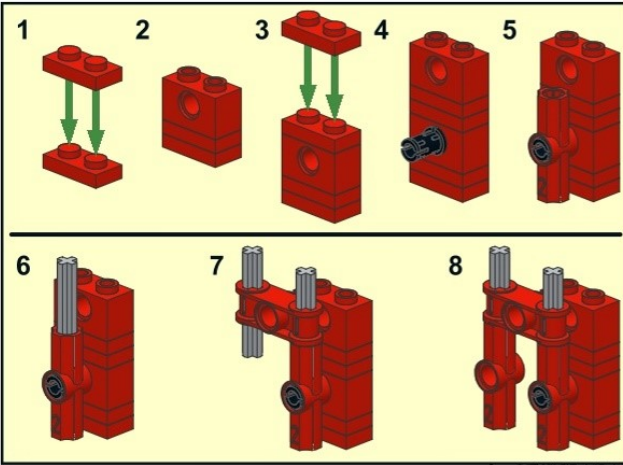
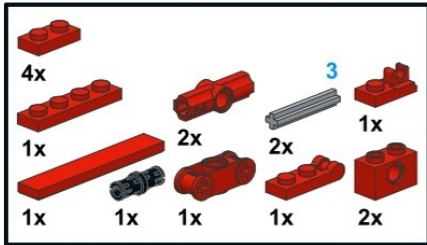



1

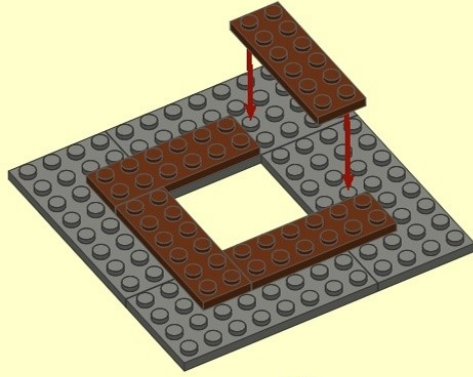
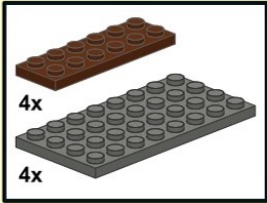

2

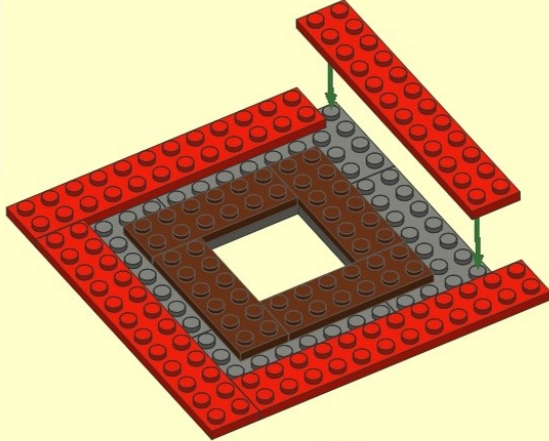
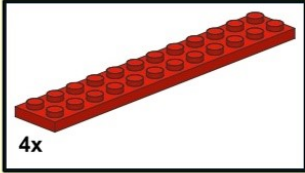

3

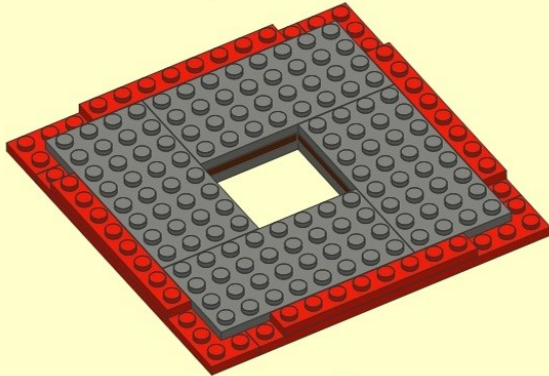
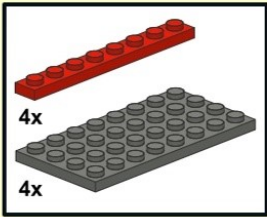

4

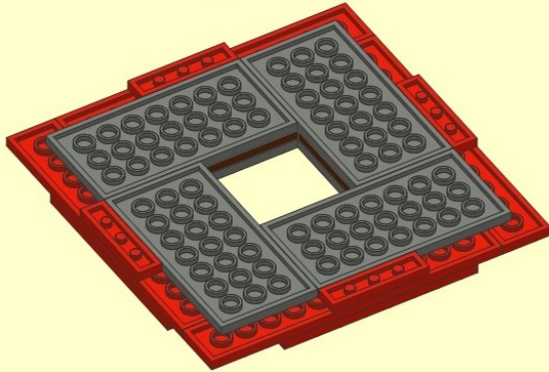
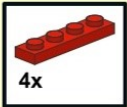

5

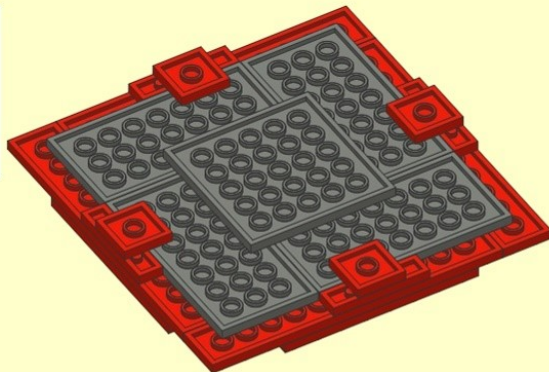
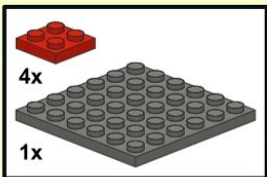

**6**

2x	2x
1x	2x

1

2

---

3

4

**7**

2x	1x
1x	2x
	2x

1

2

---

3

4

**8**

2x	
1x	1x

1

2

3



9

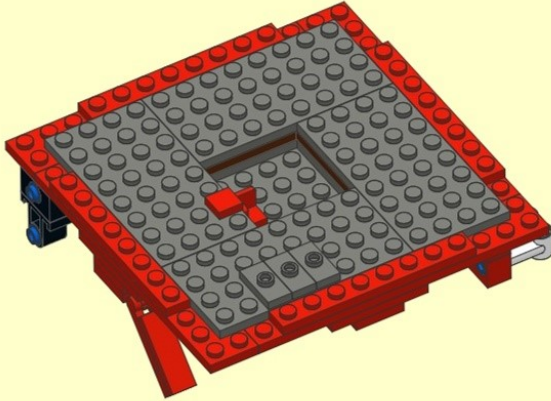
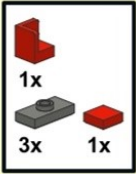

10

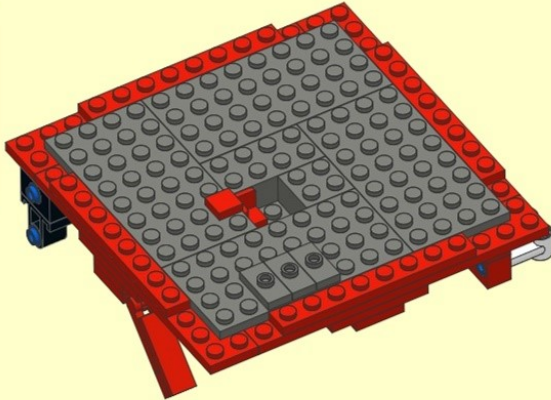
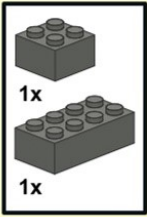

167

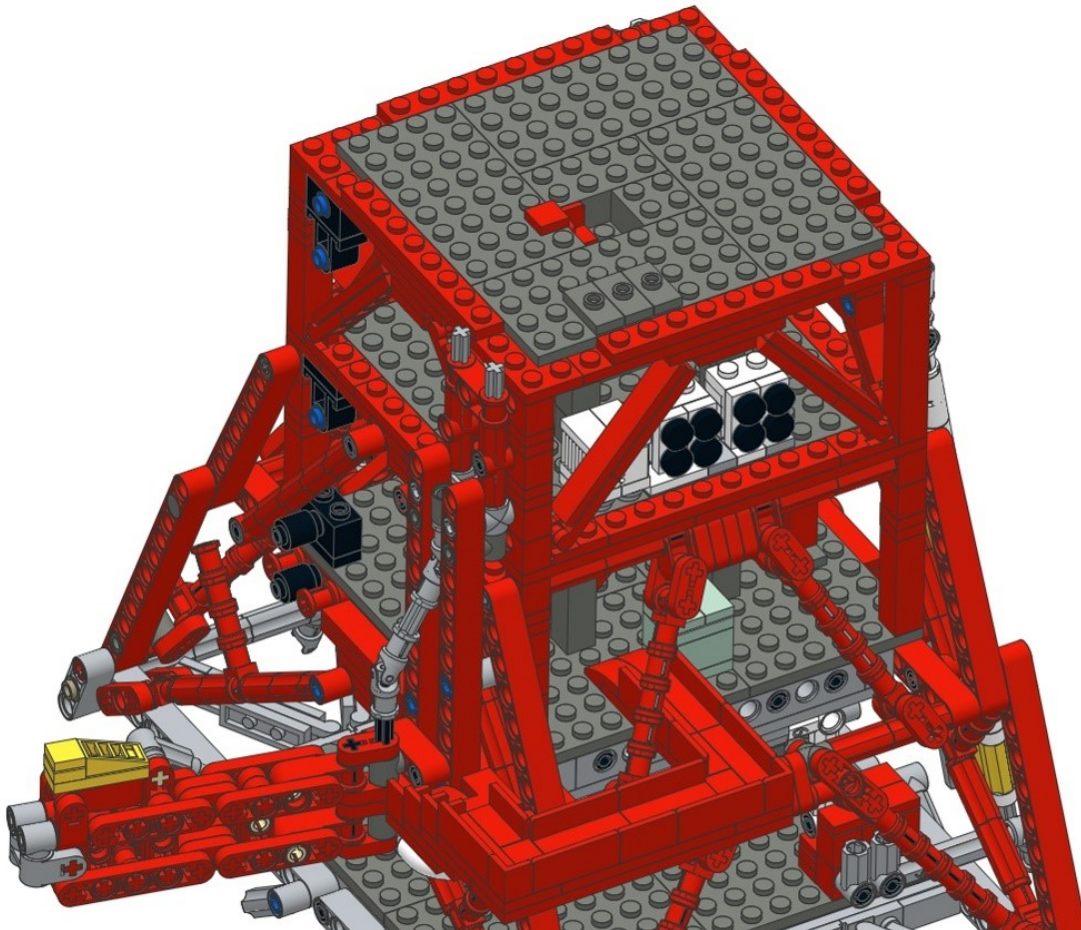

168

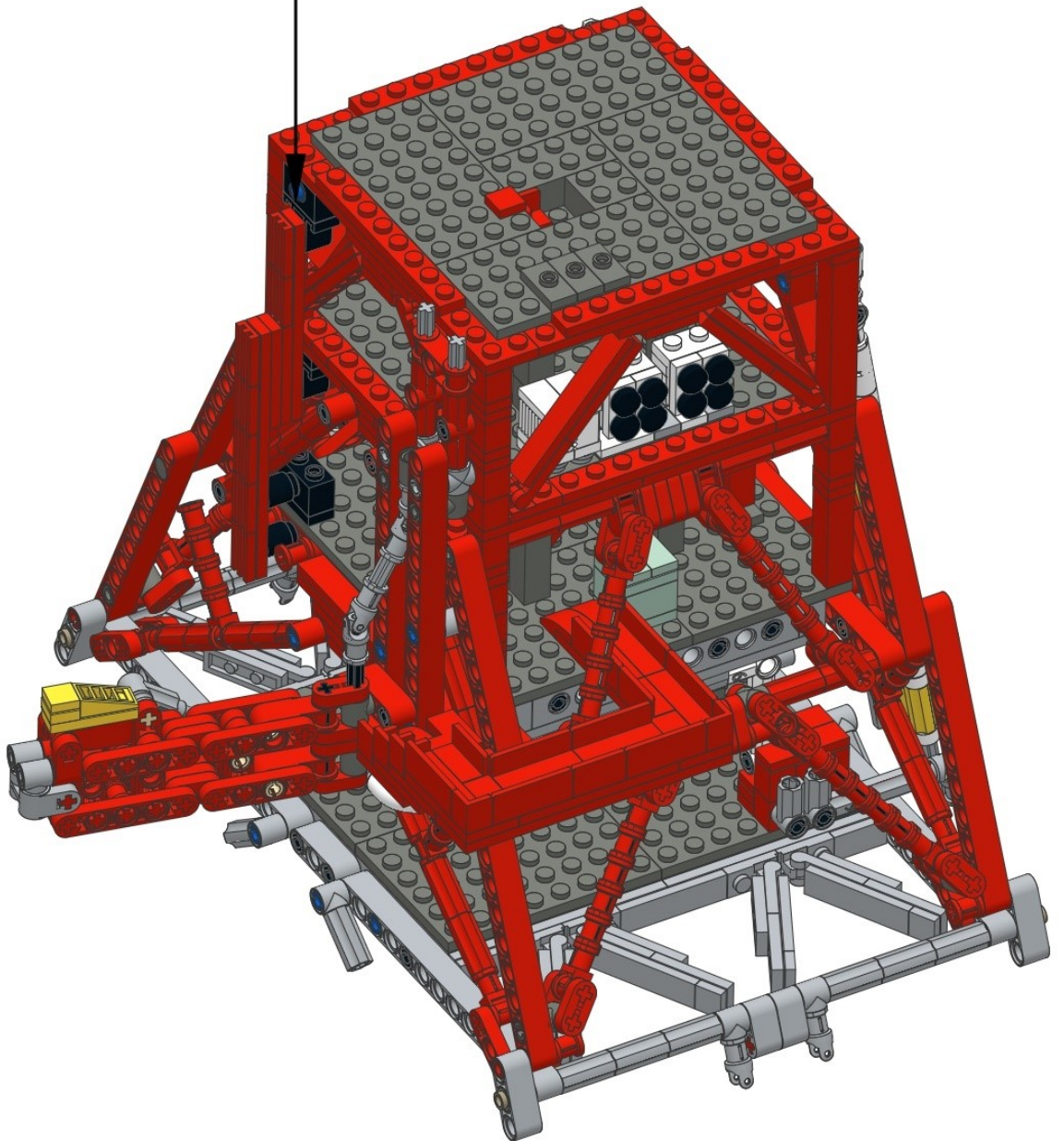
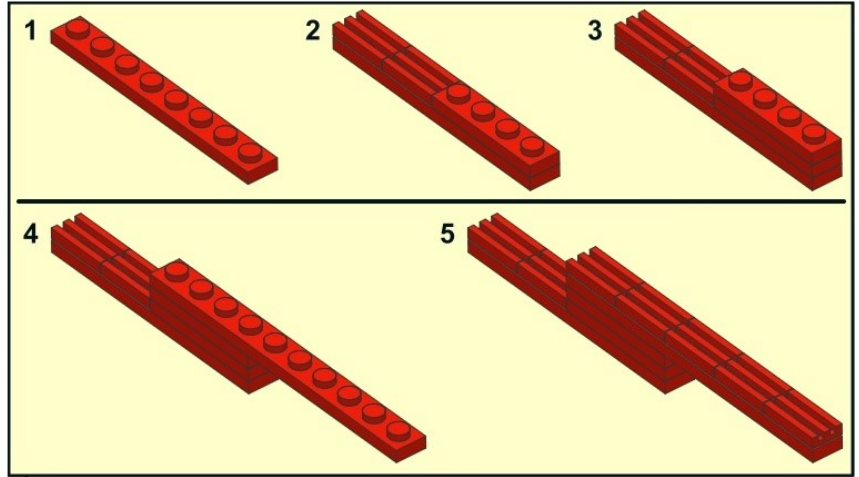
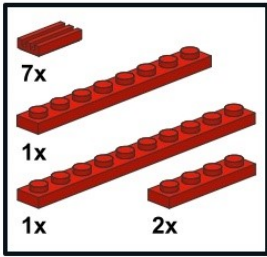



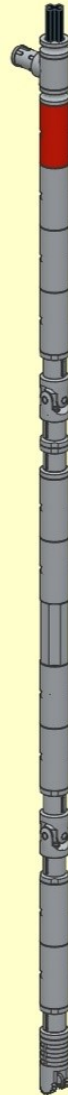
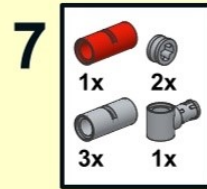
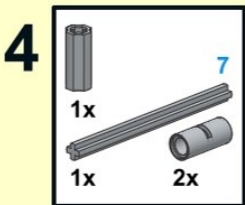
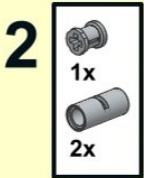
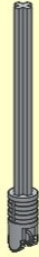
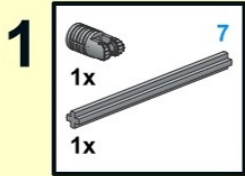

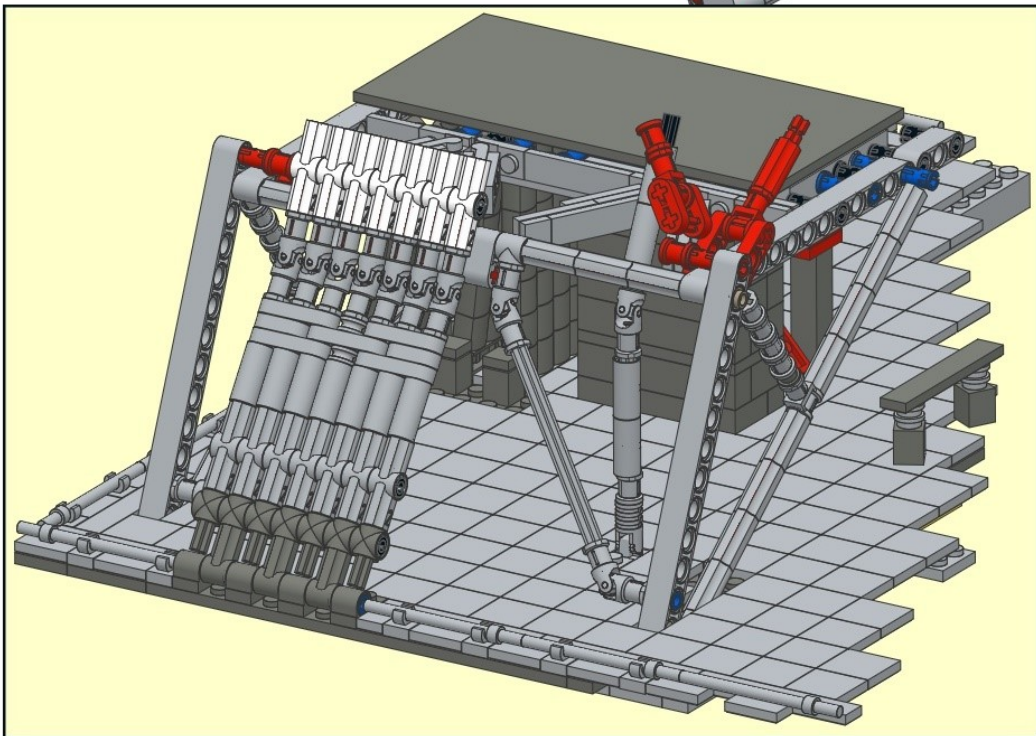
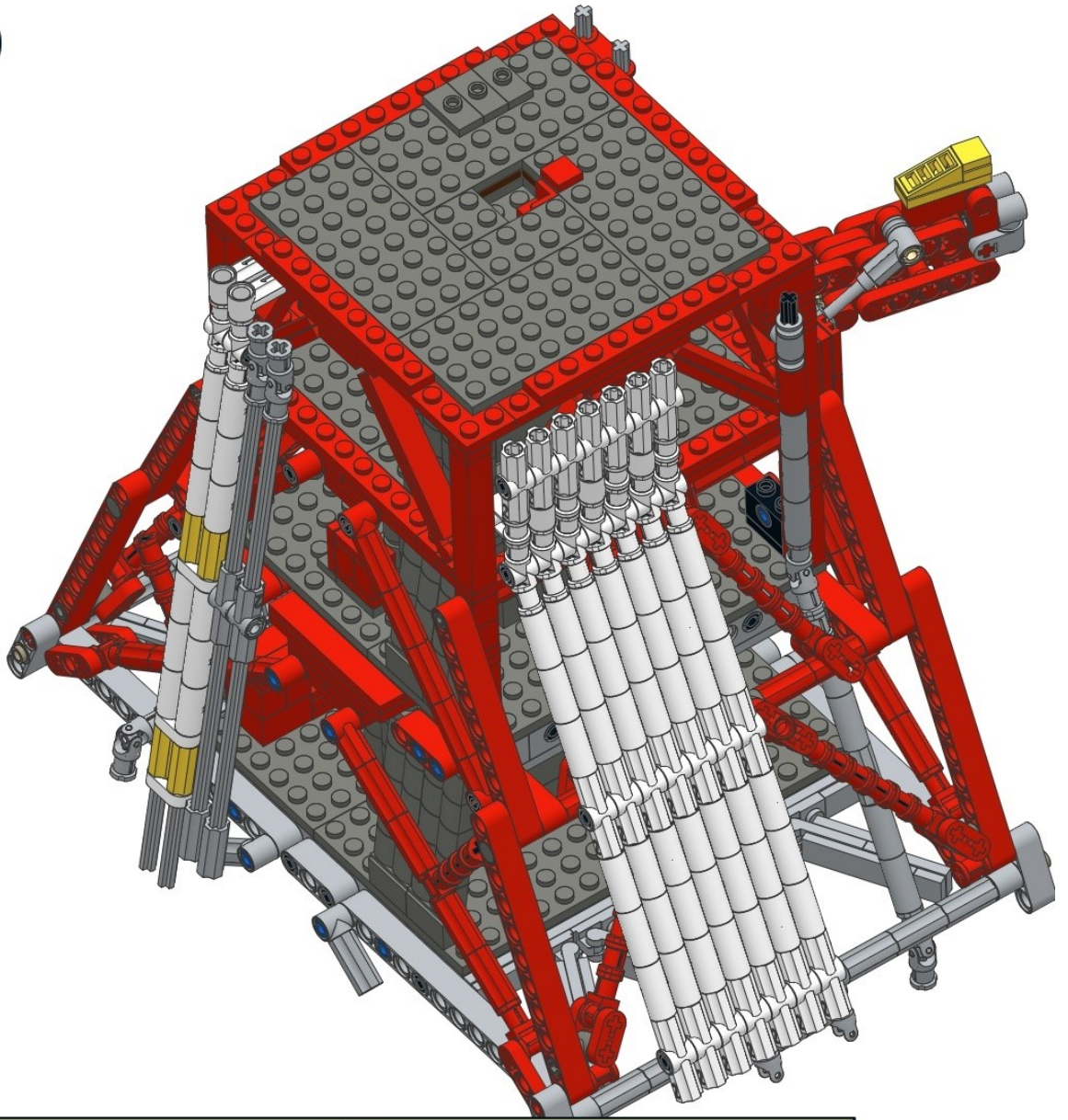



170

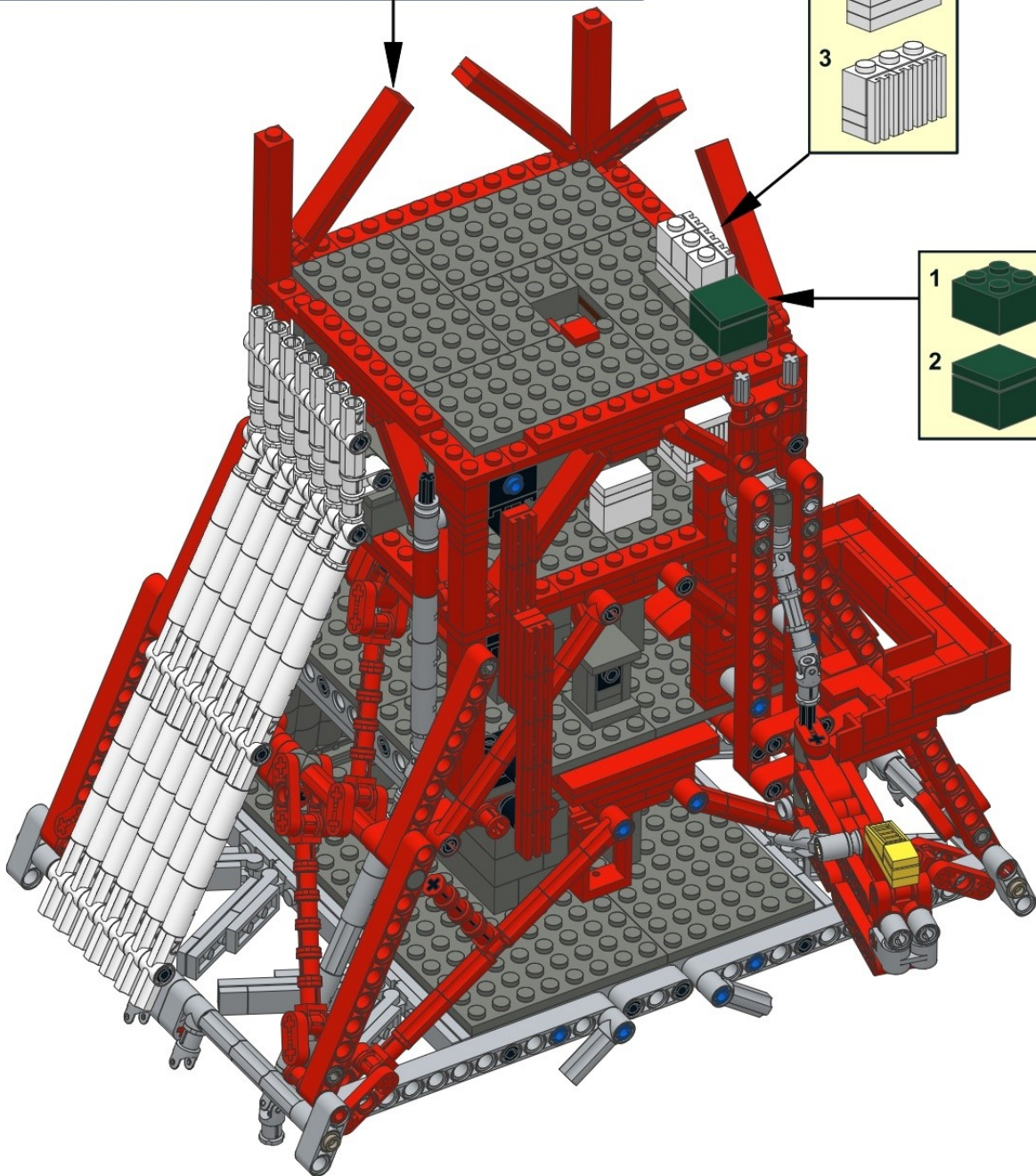
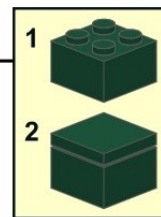
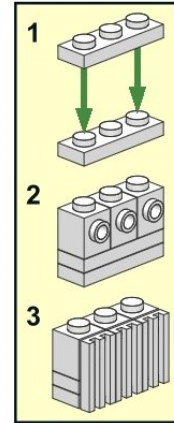
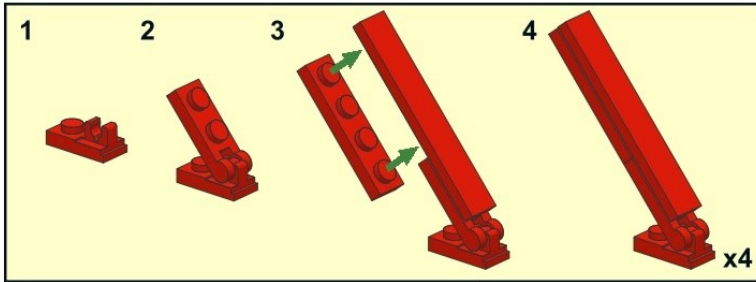
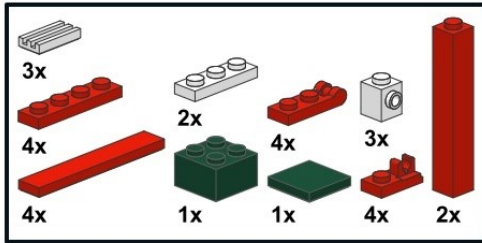

171

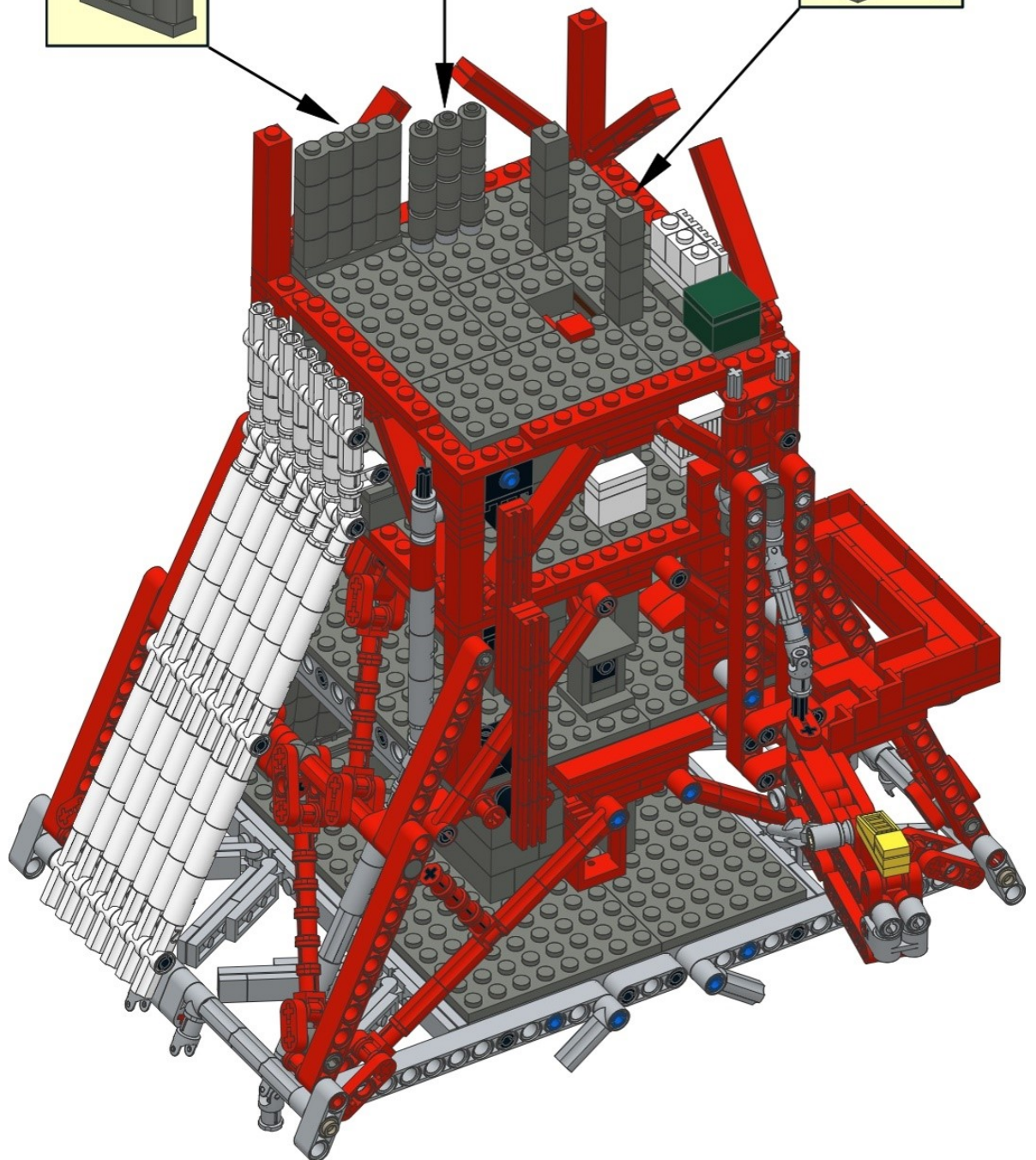
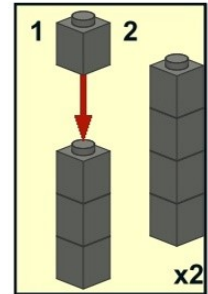
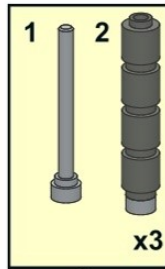
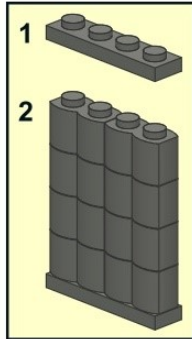
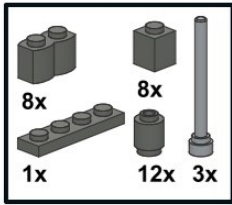



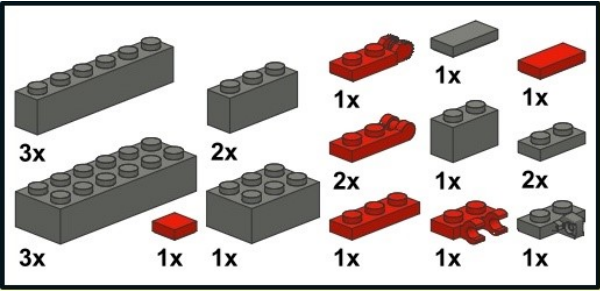

1

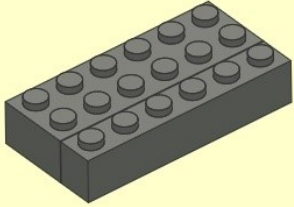

2

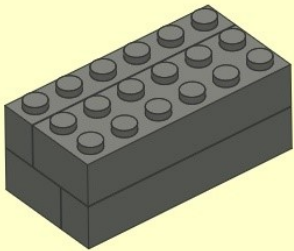

3

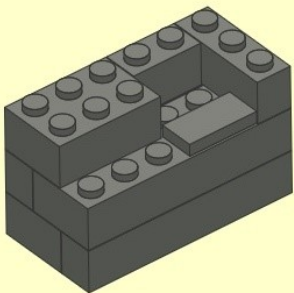

4

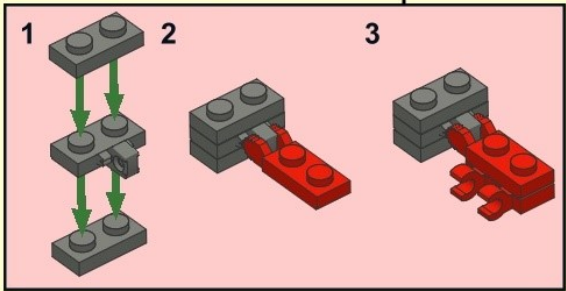
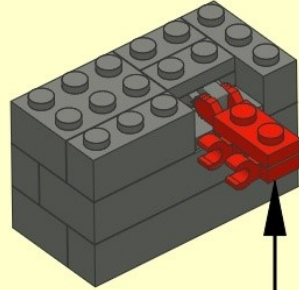

5

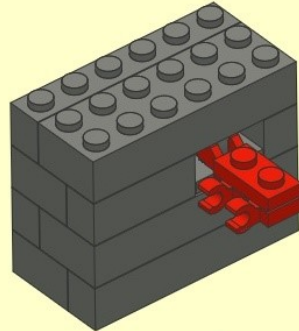

6

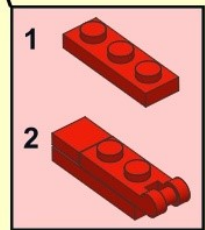
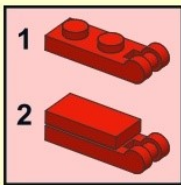
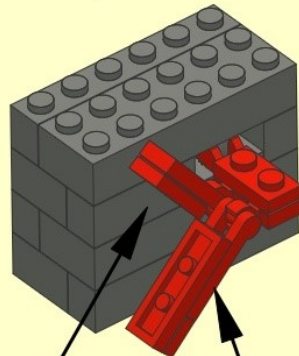

172

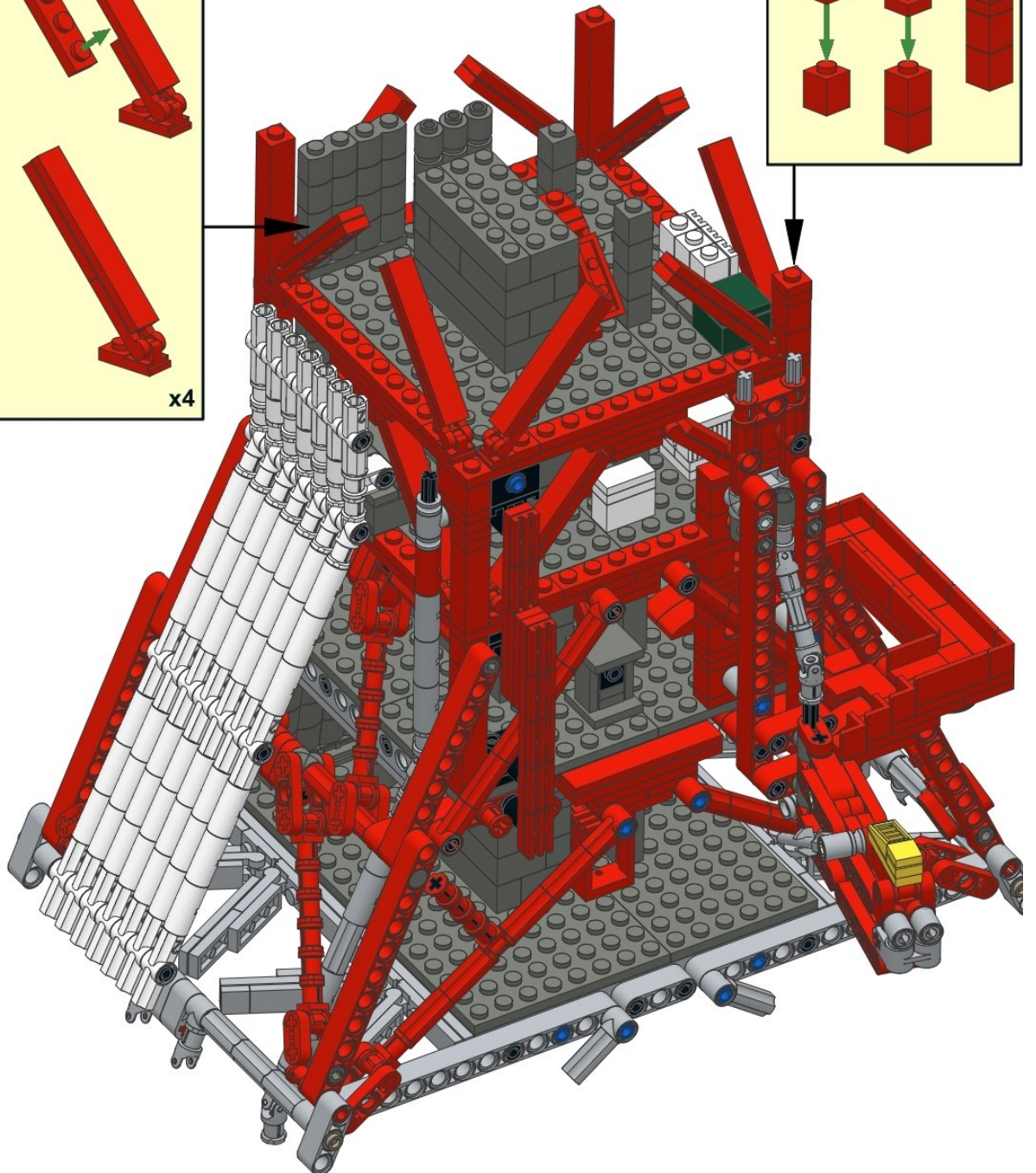
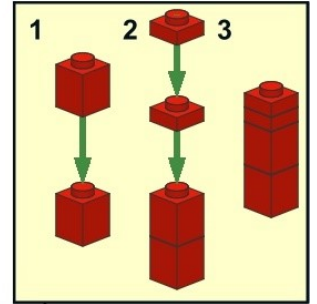
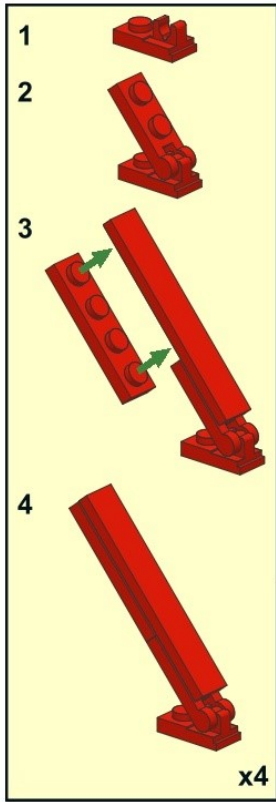
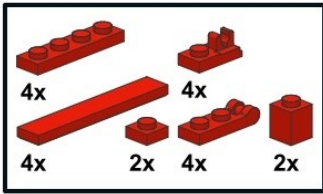



173

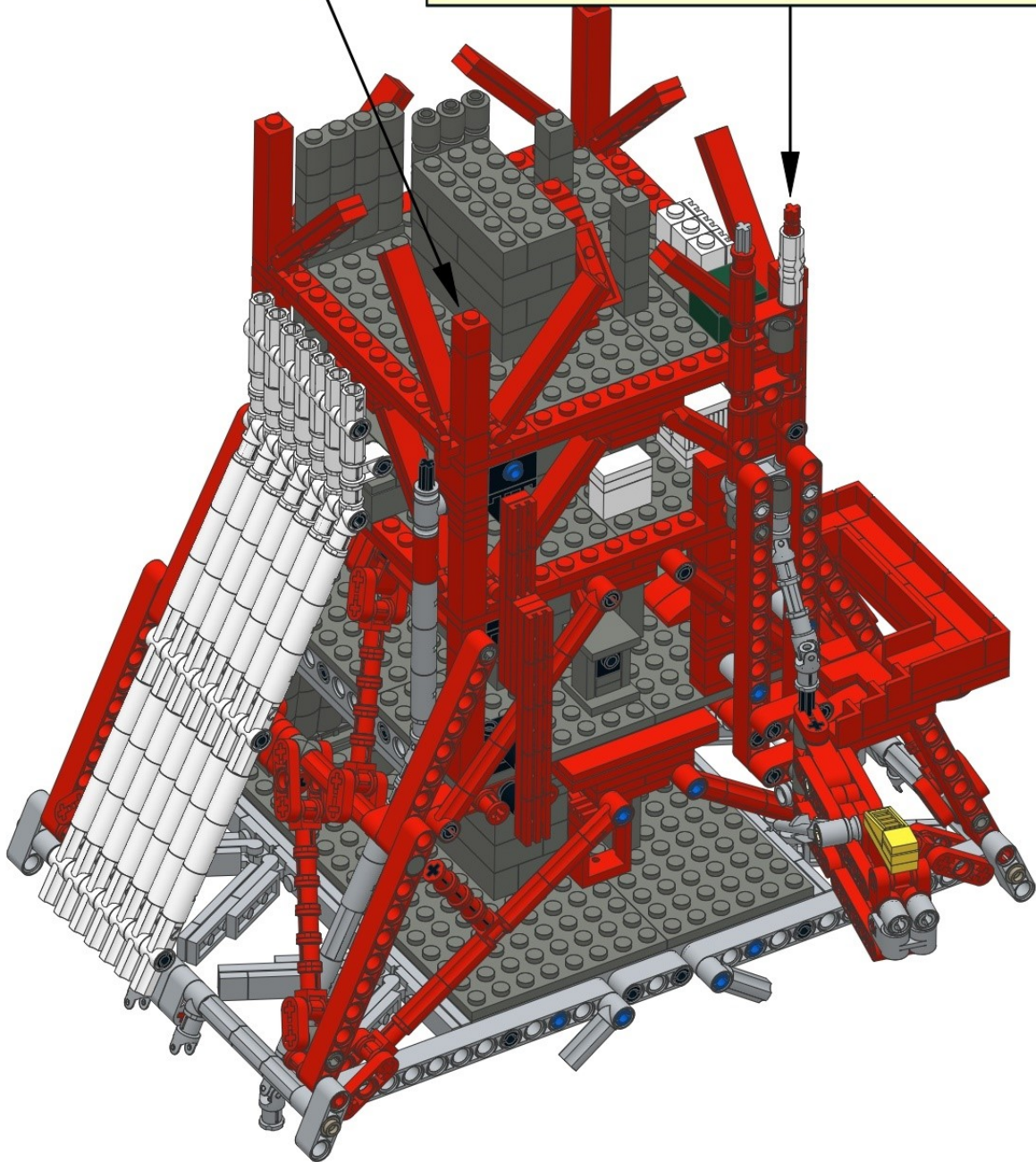
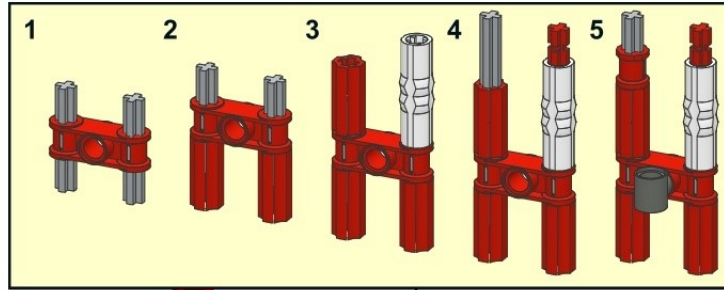
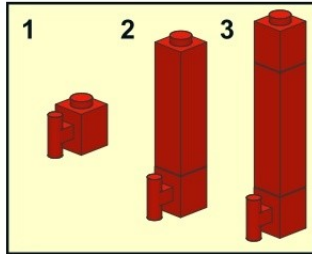
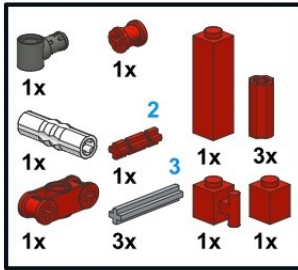

174

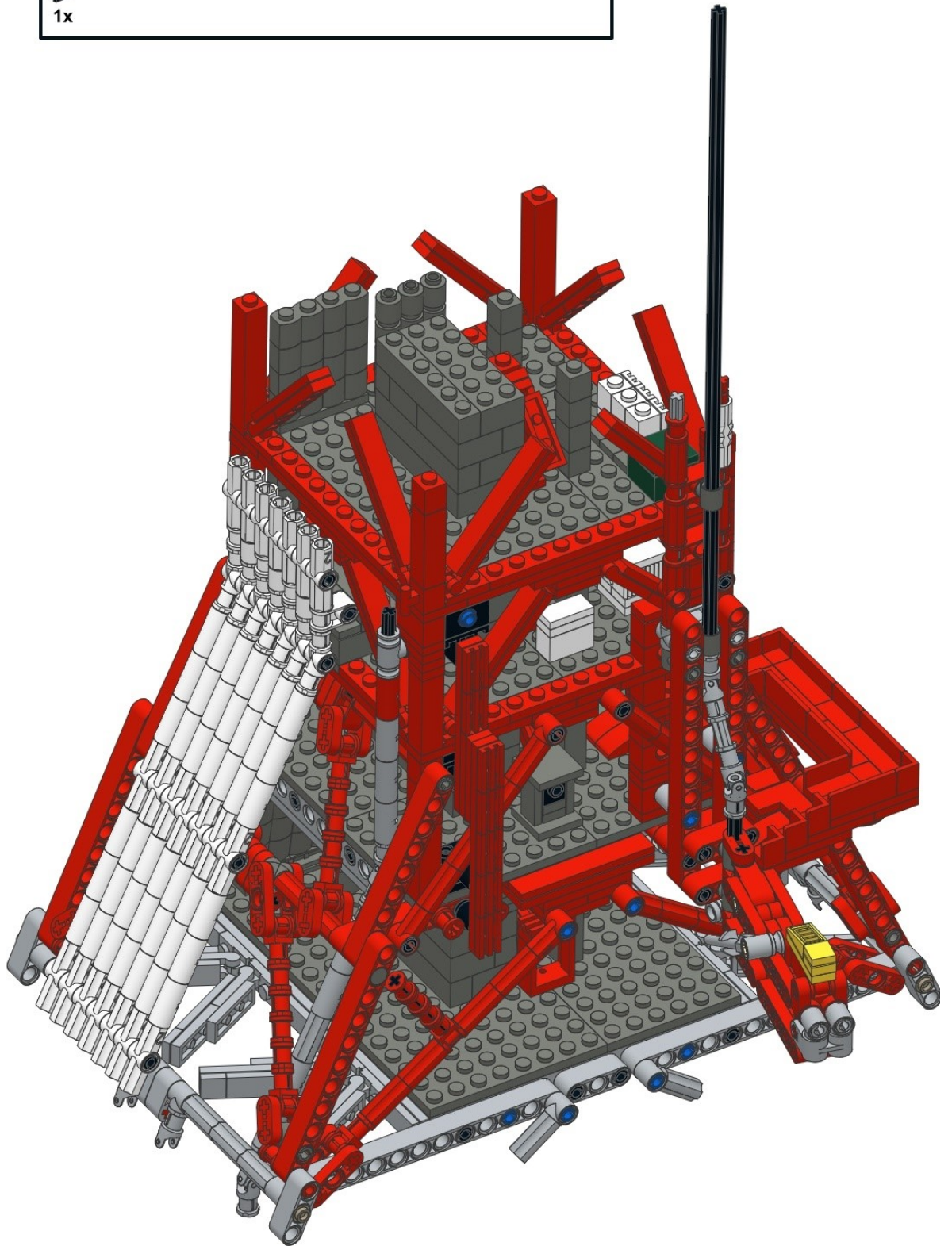
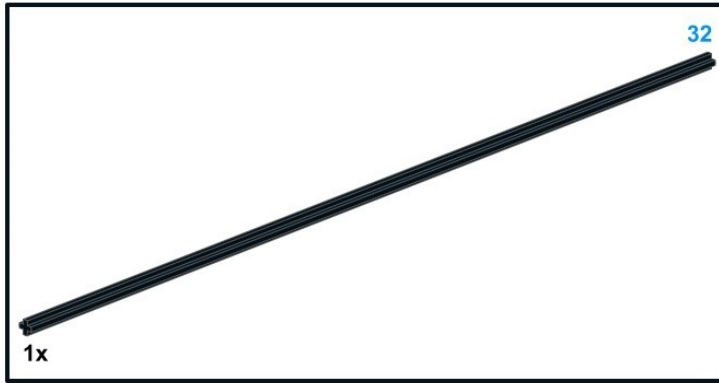



175

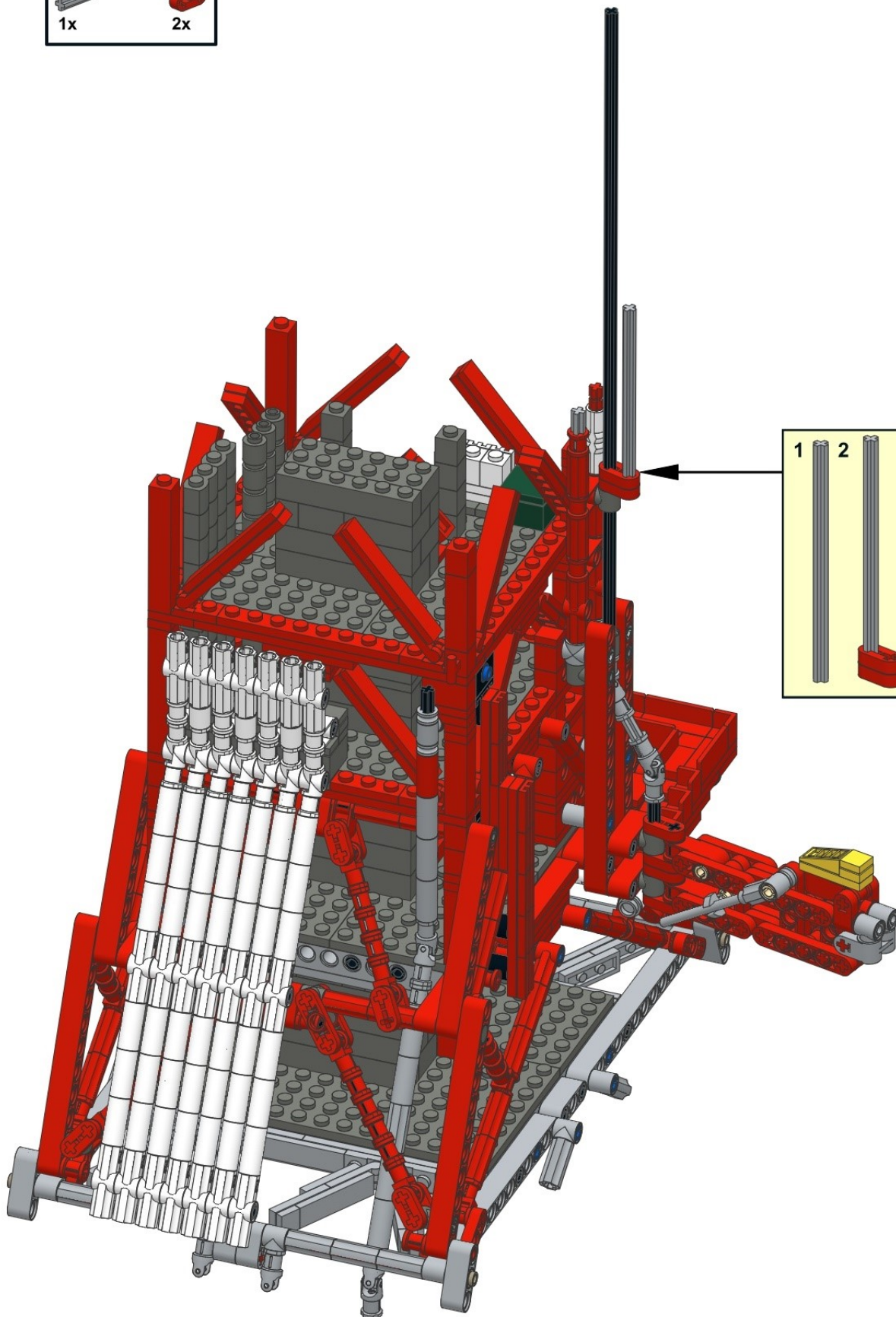
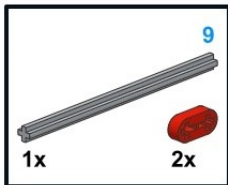

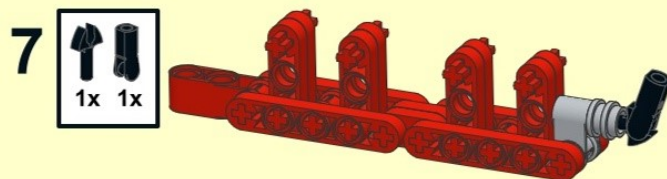
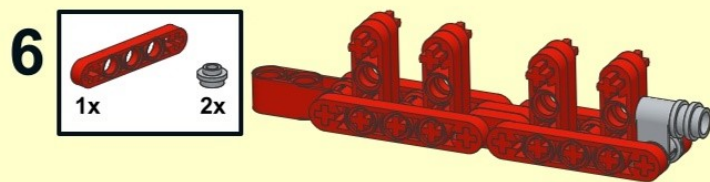
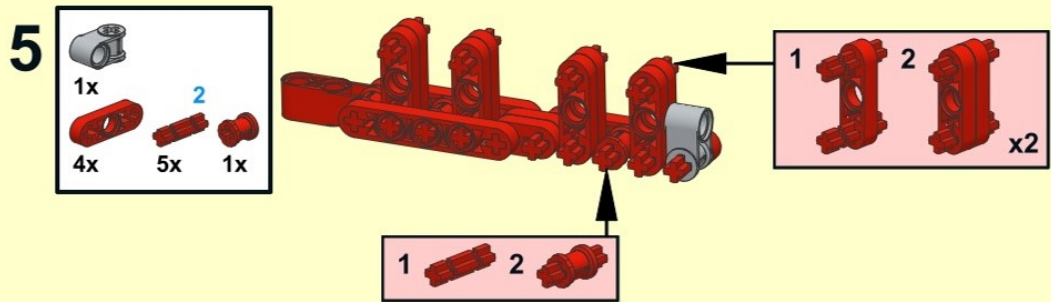
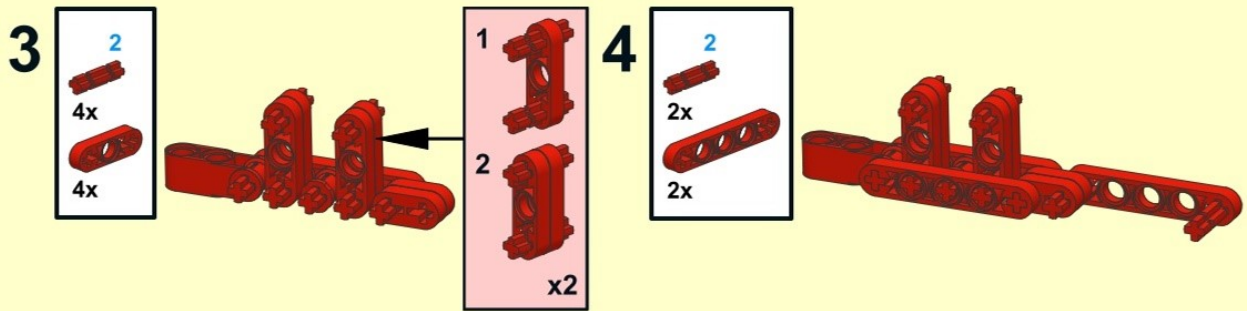
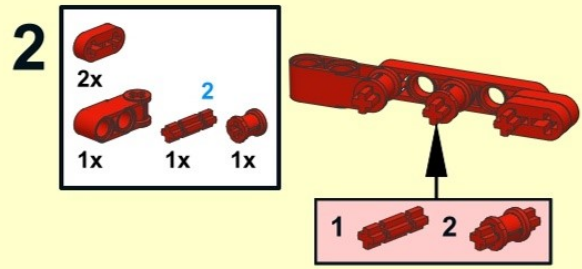
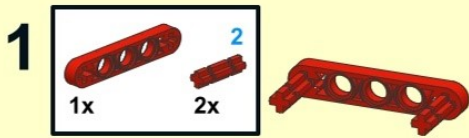



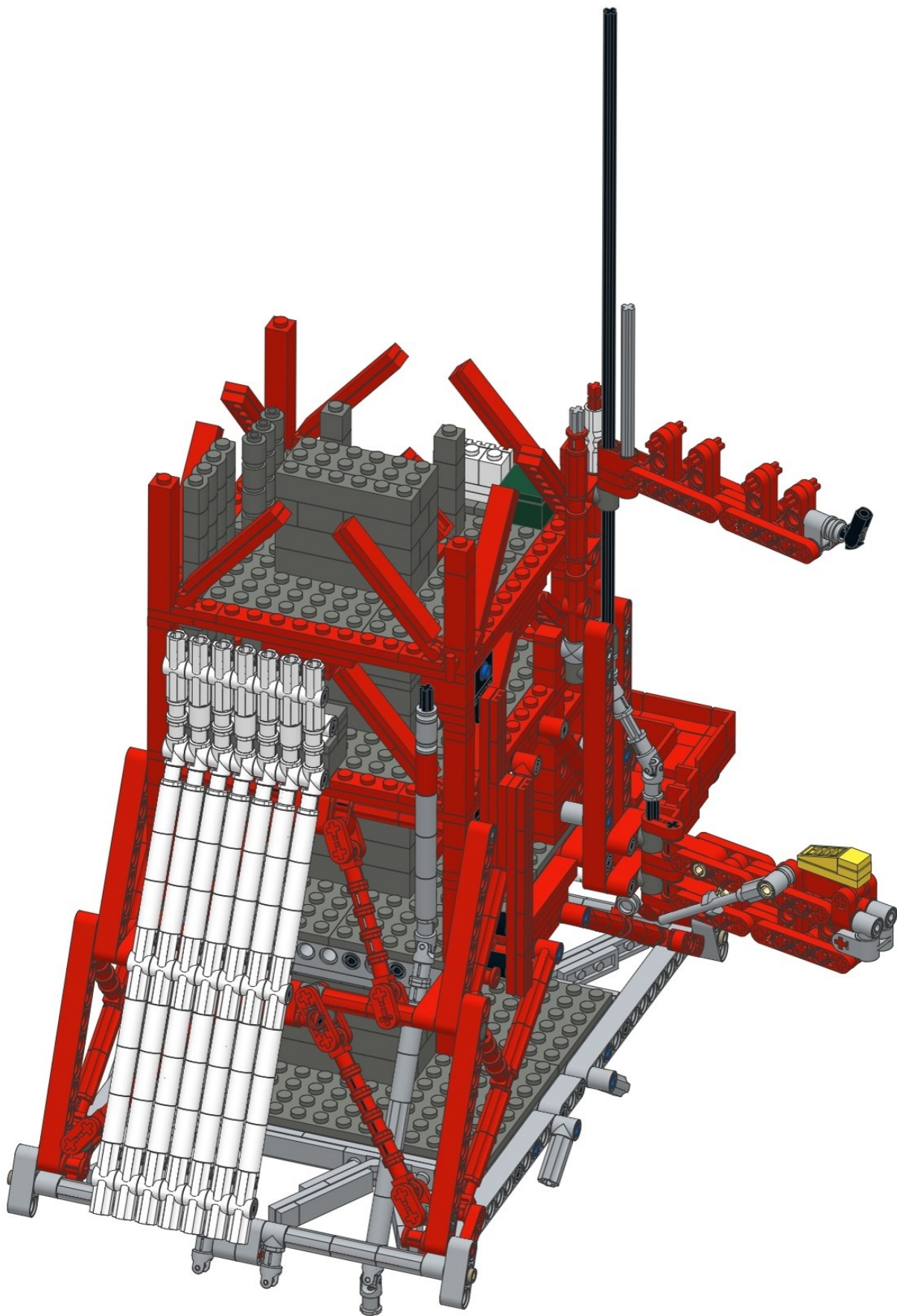

1

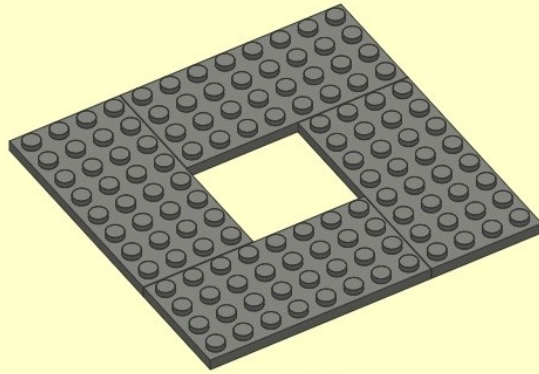
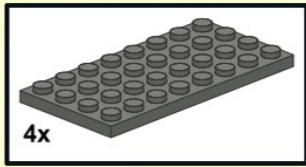

2

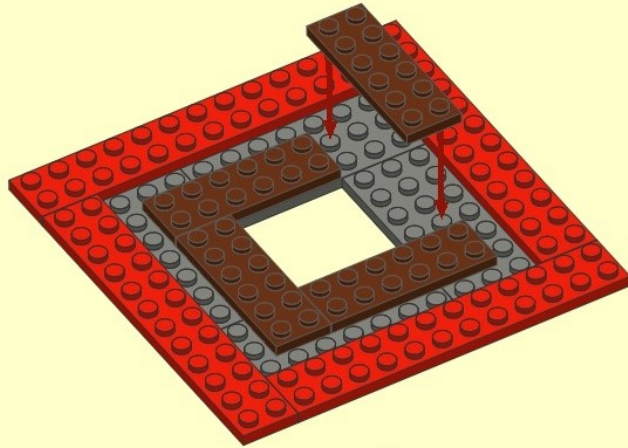
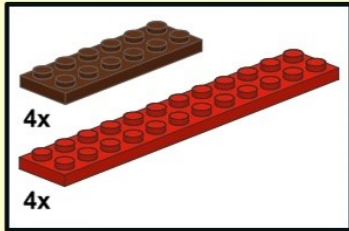

3

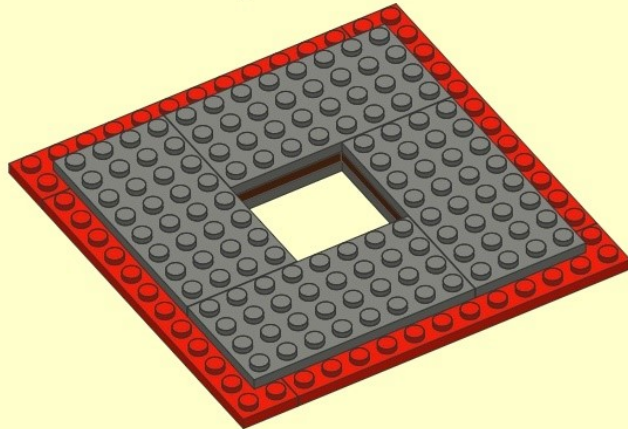
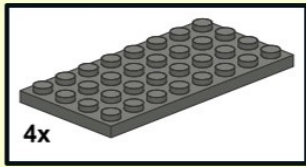

4

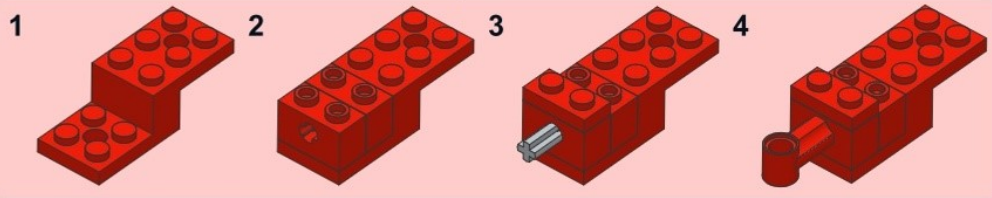
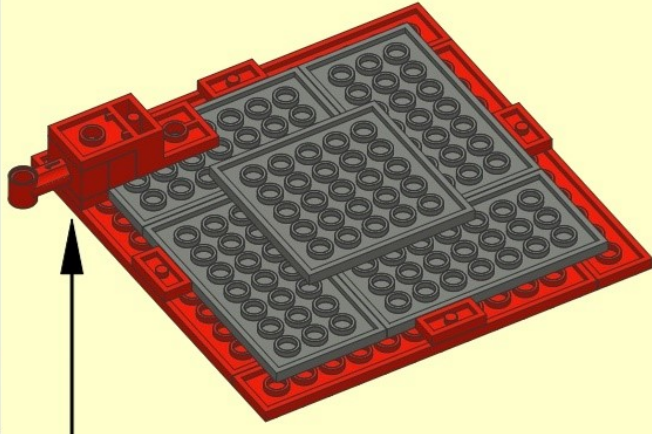
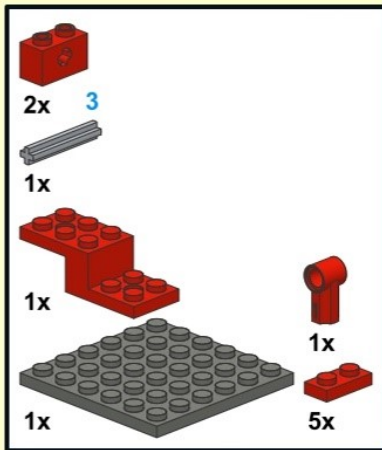



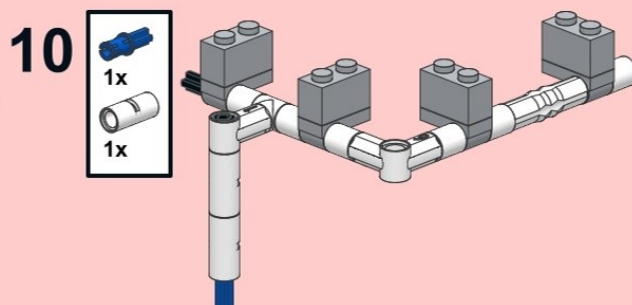
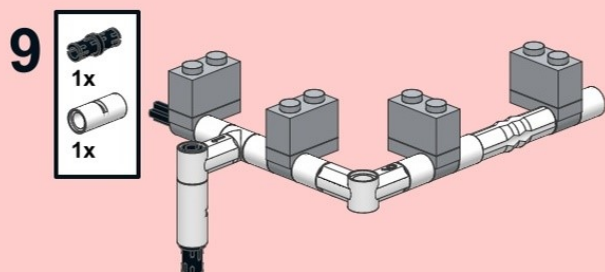
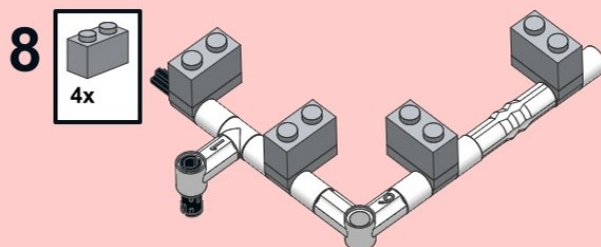
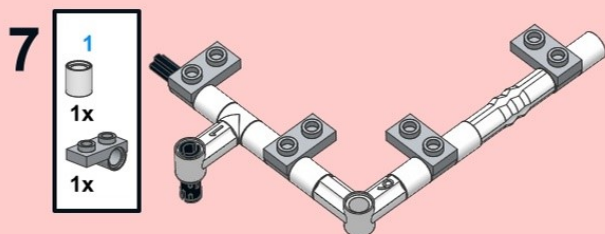
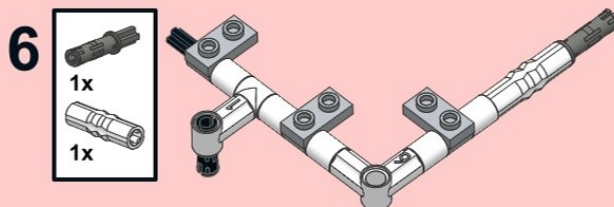
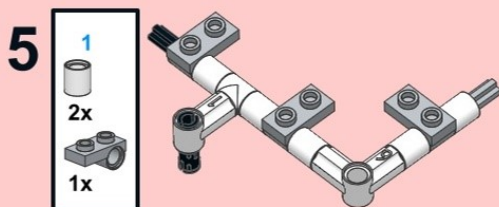
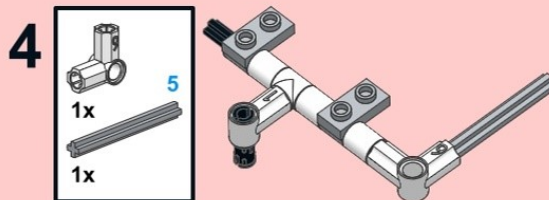
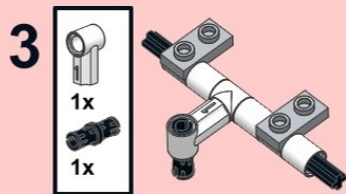
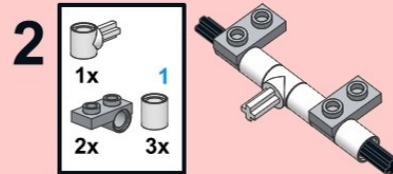

5

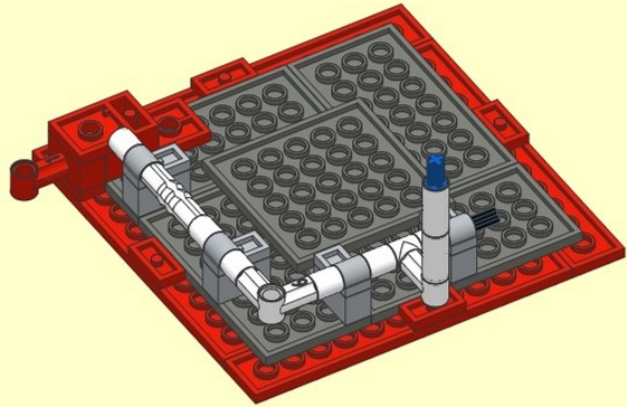

6

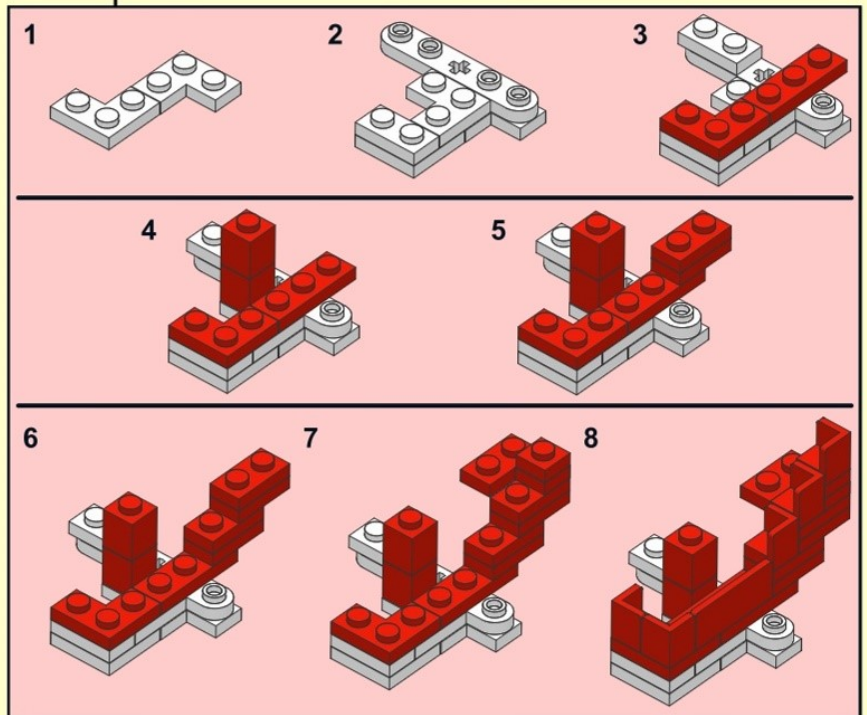
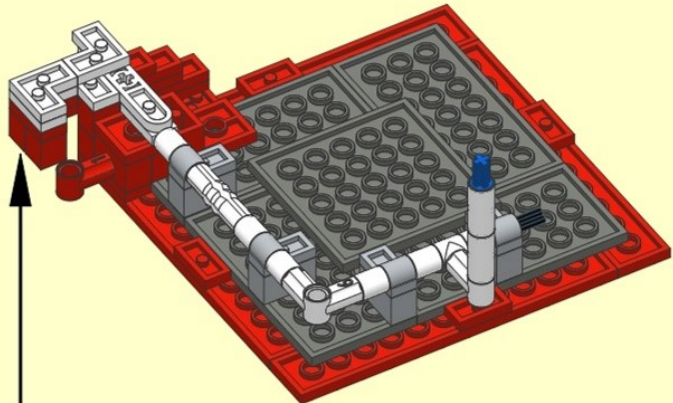
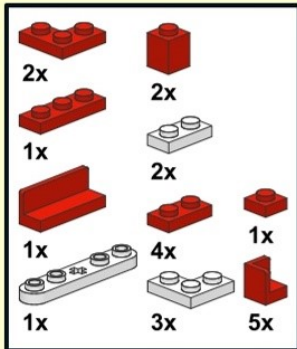



7

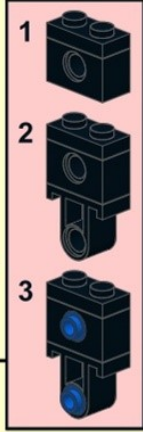
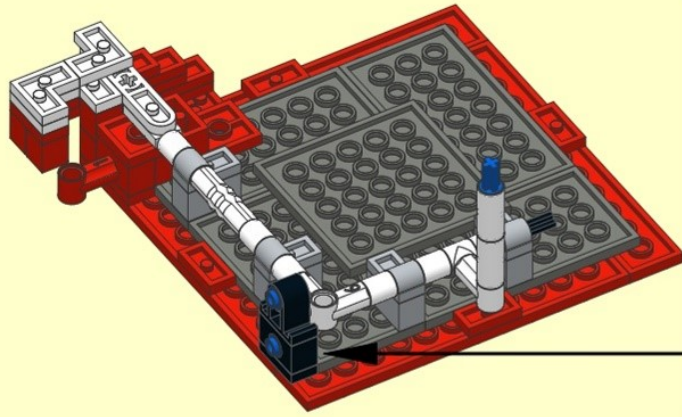

8

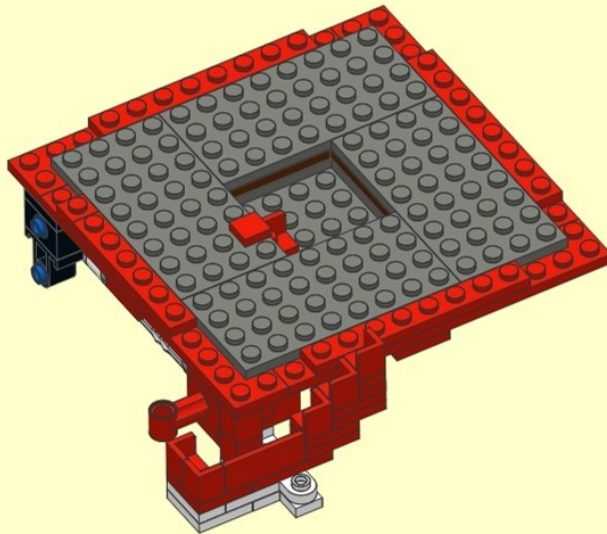
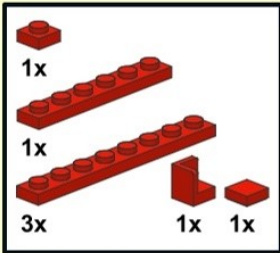

9

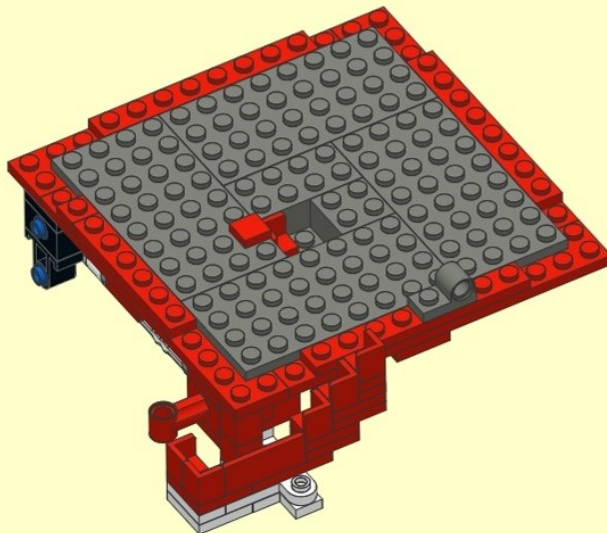
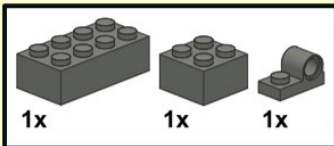

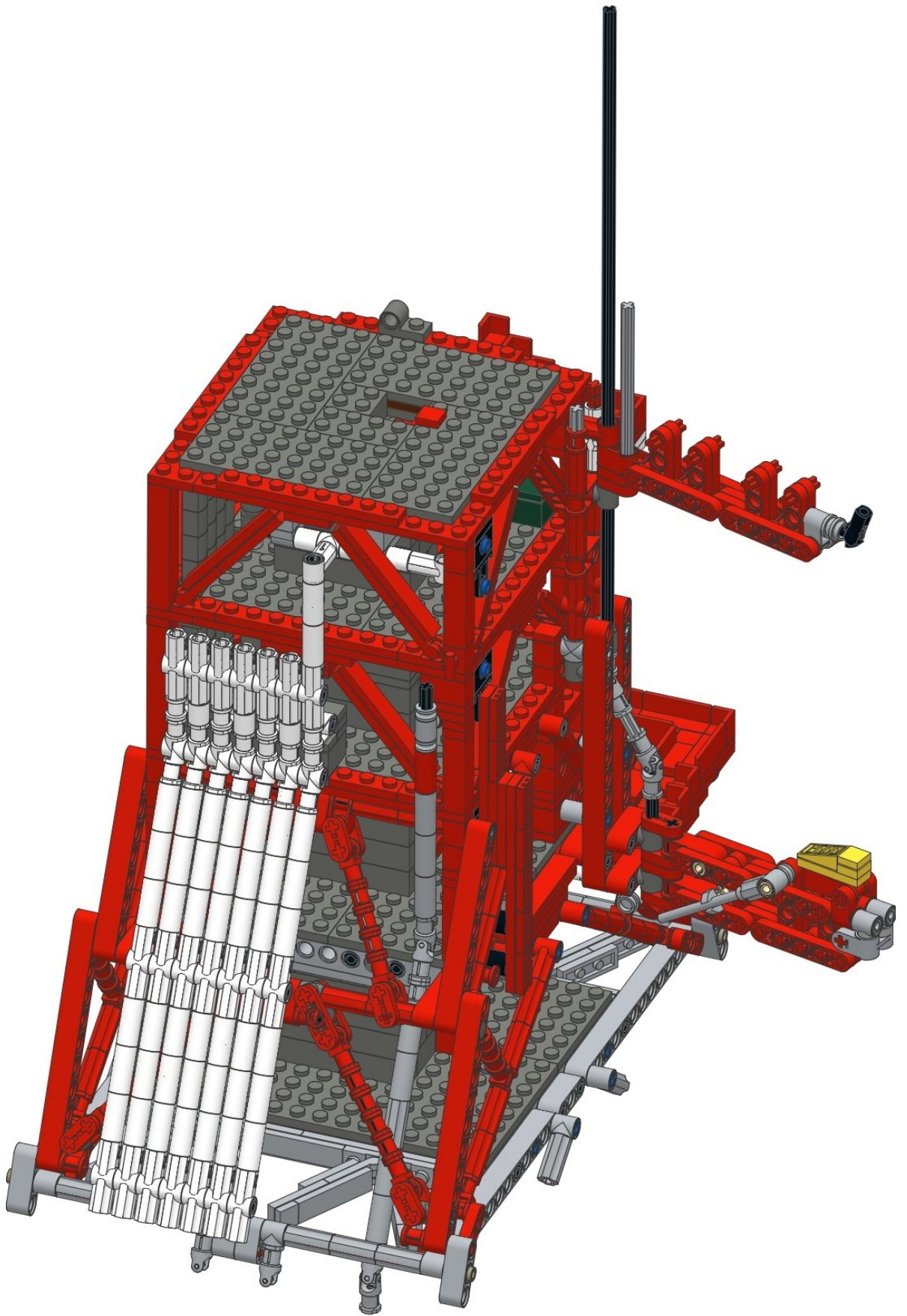



178

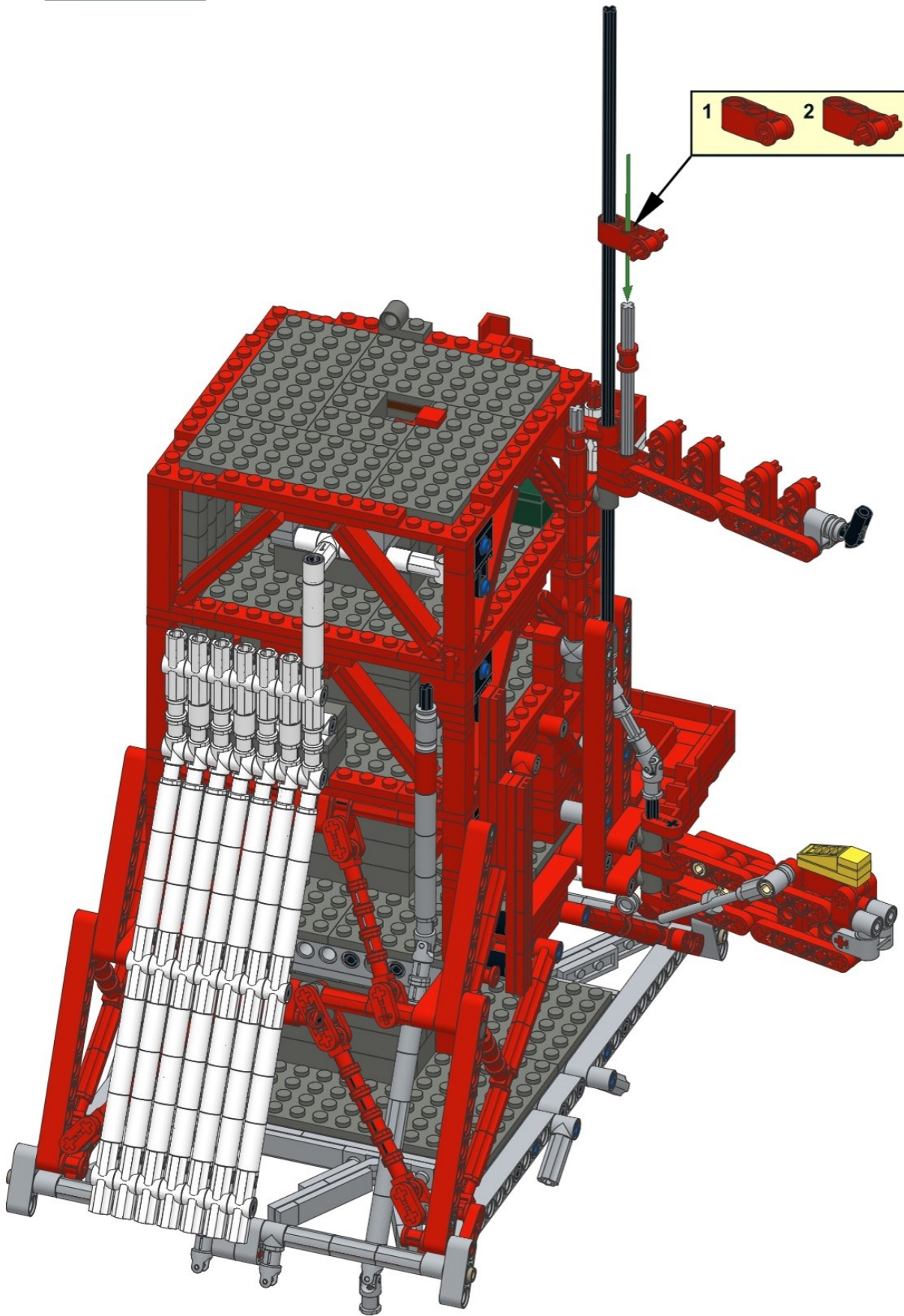
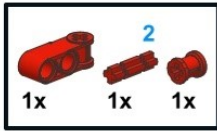

179

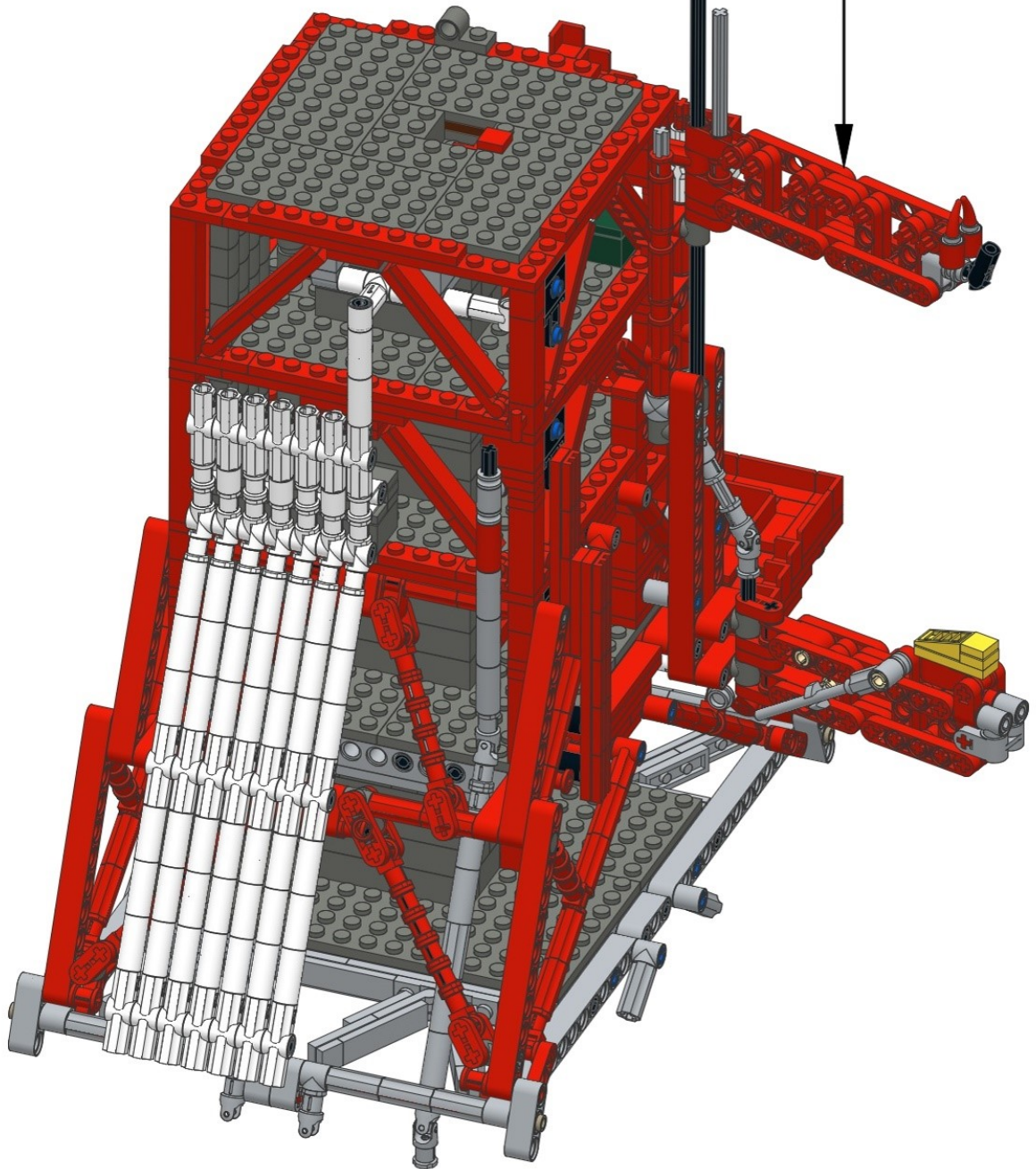
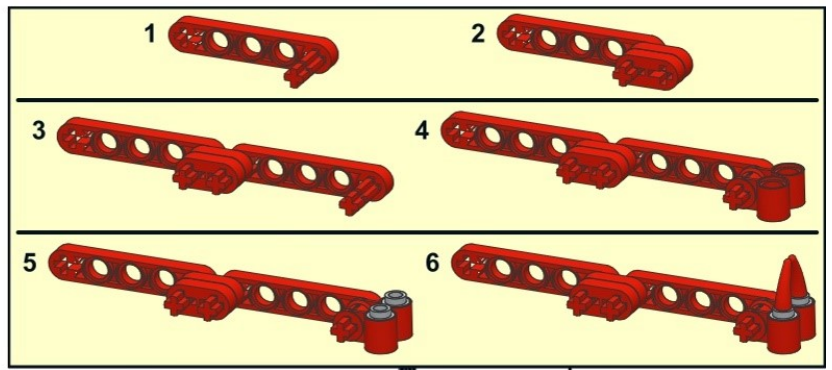
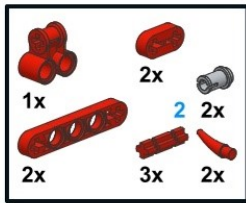



180

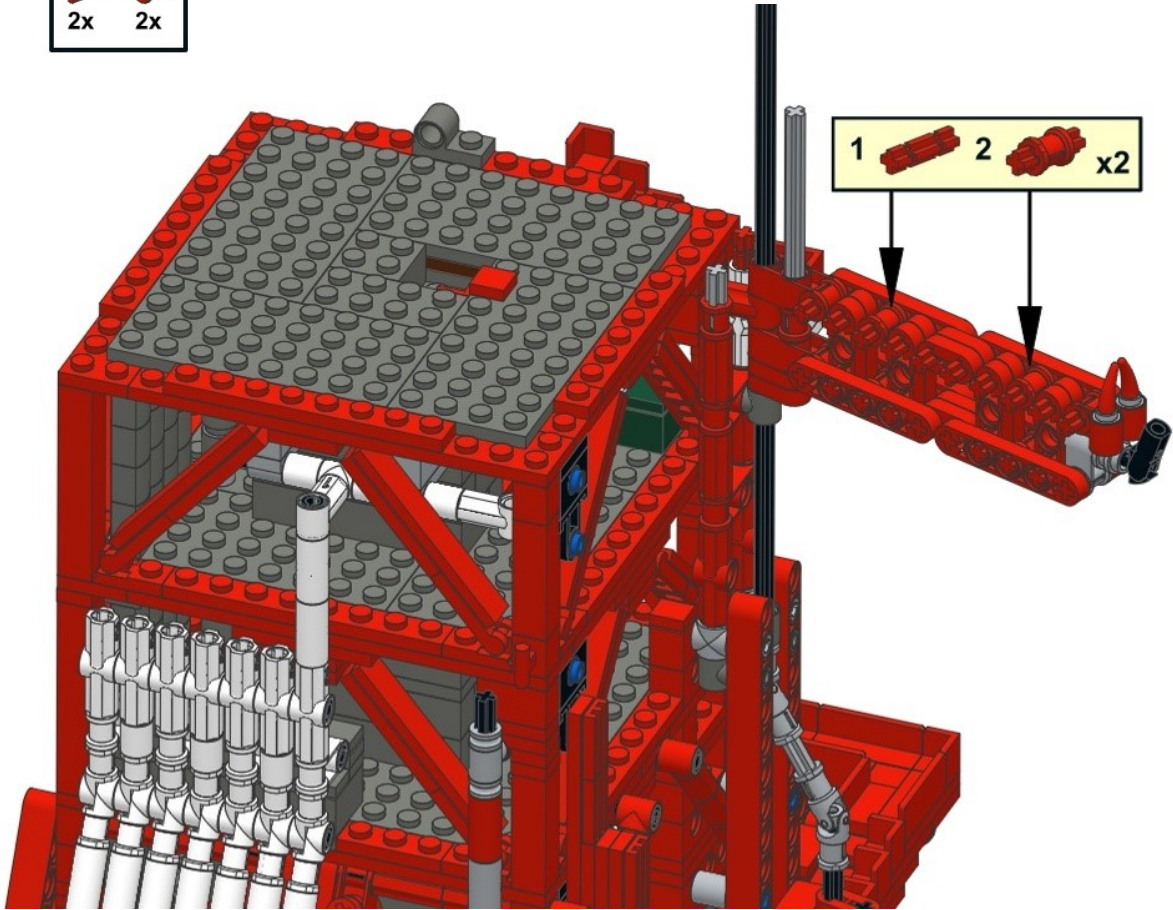
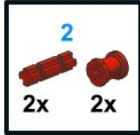

181

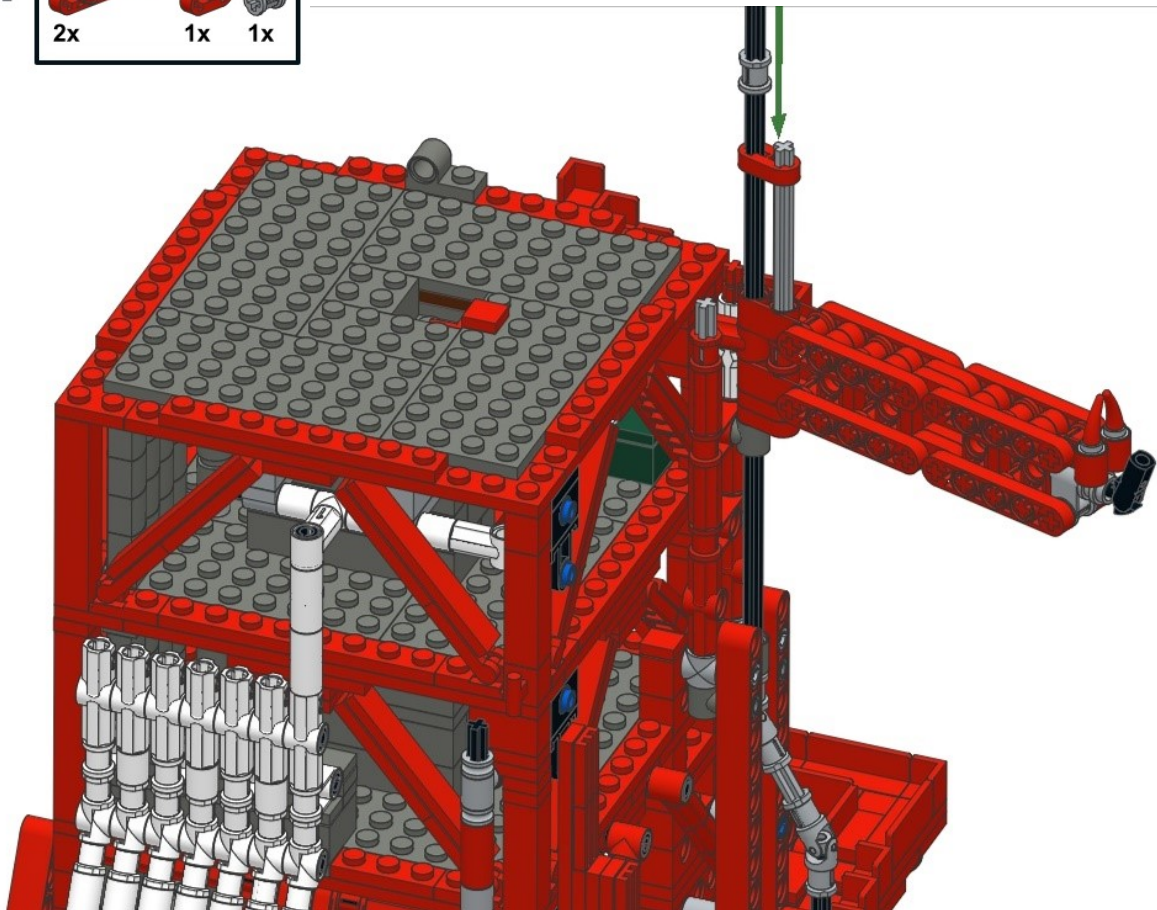
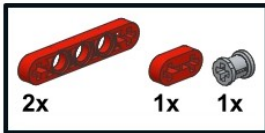

182

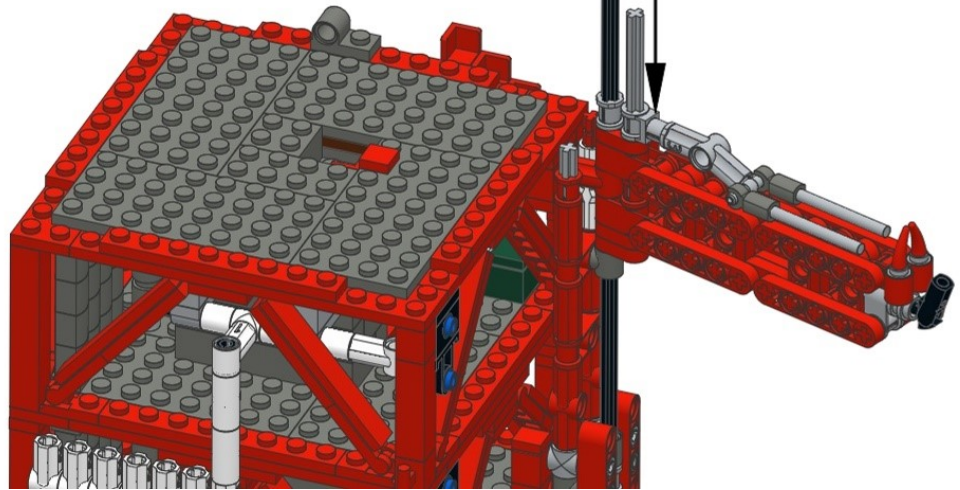
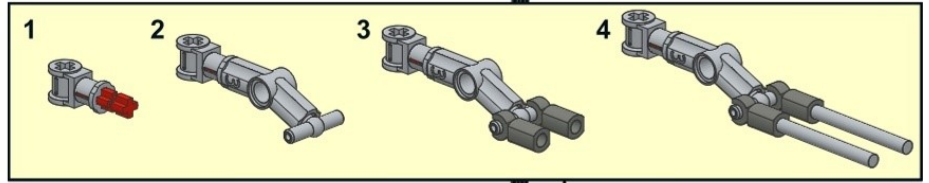
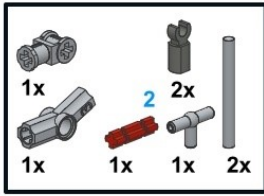

183

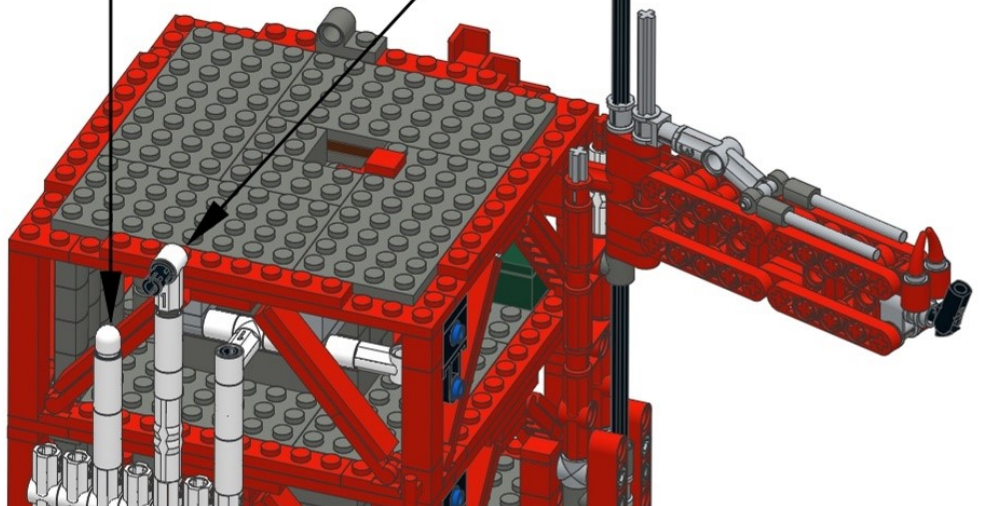
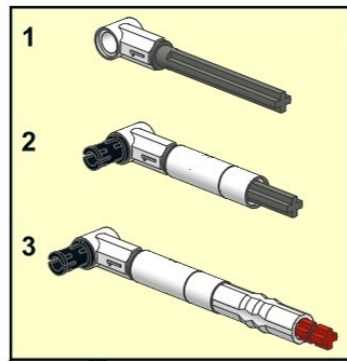
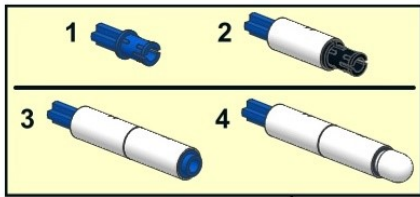



184

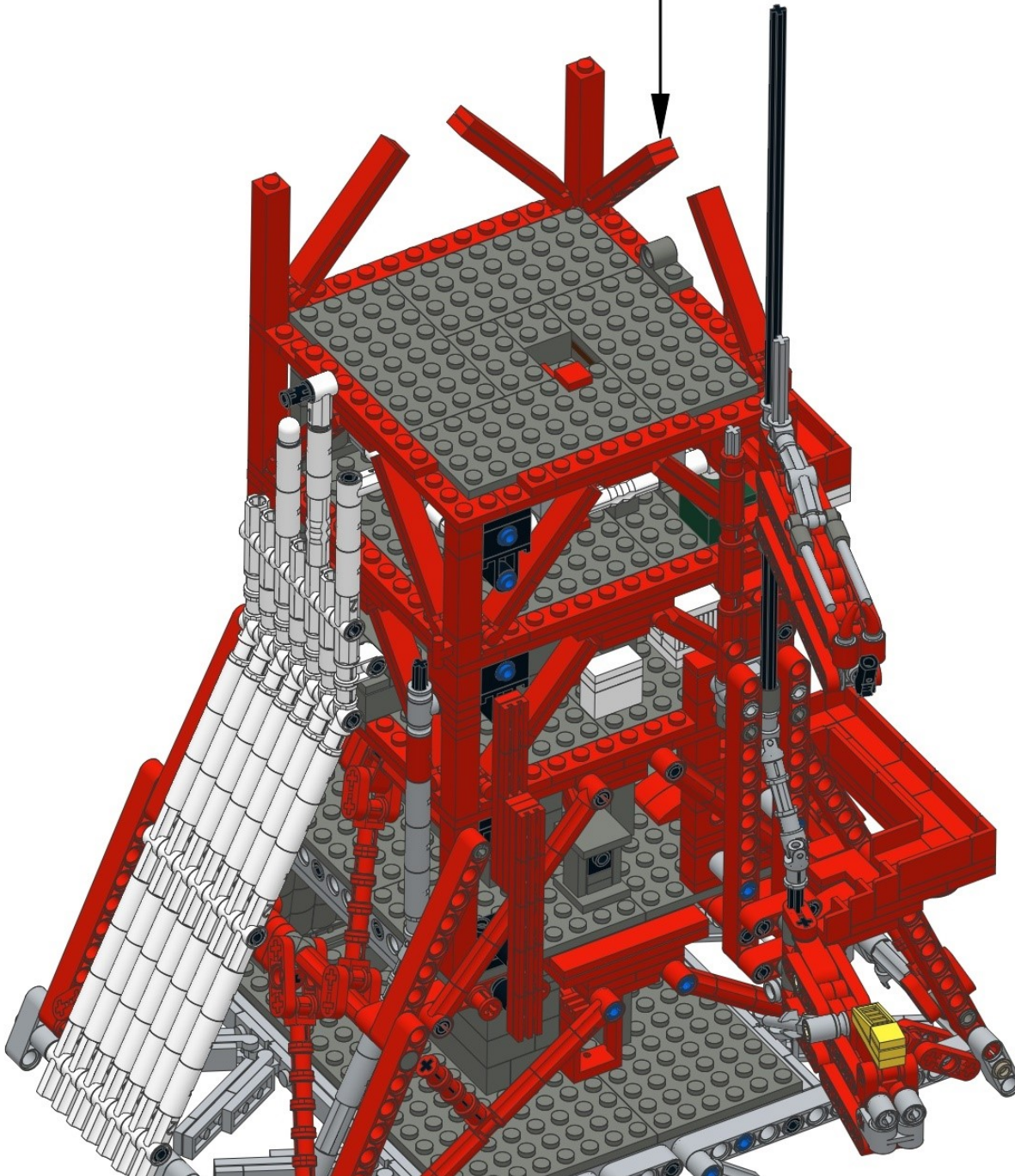
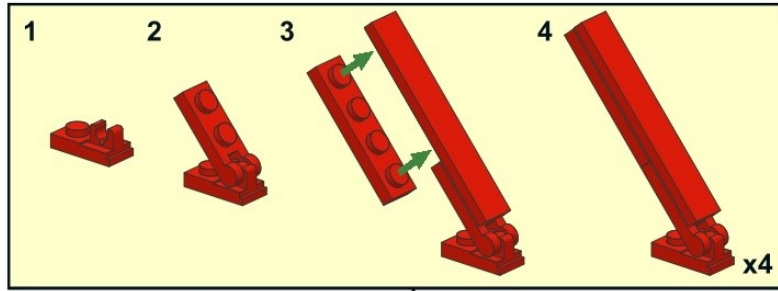
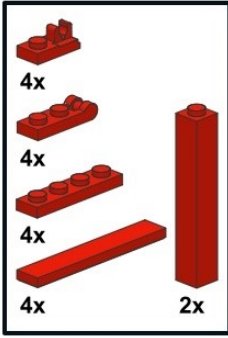

# 185

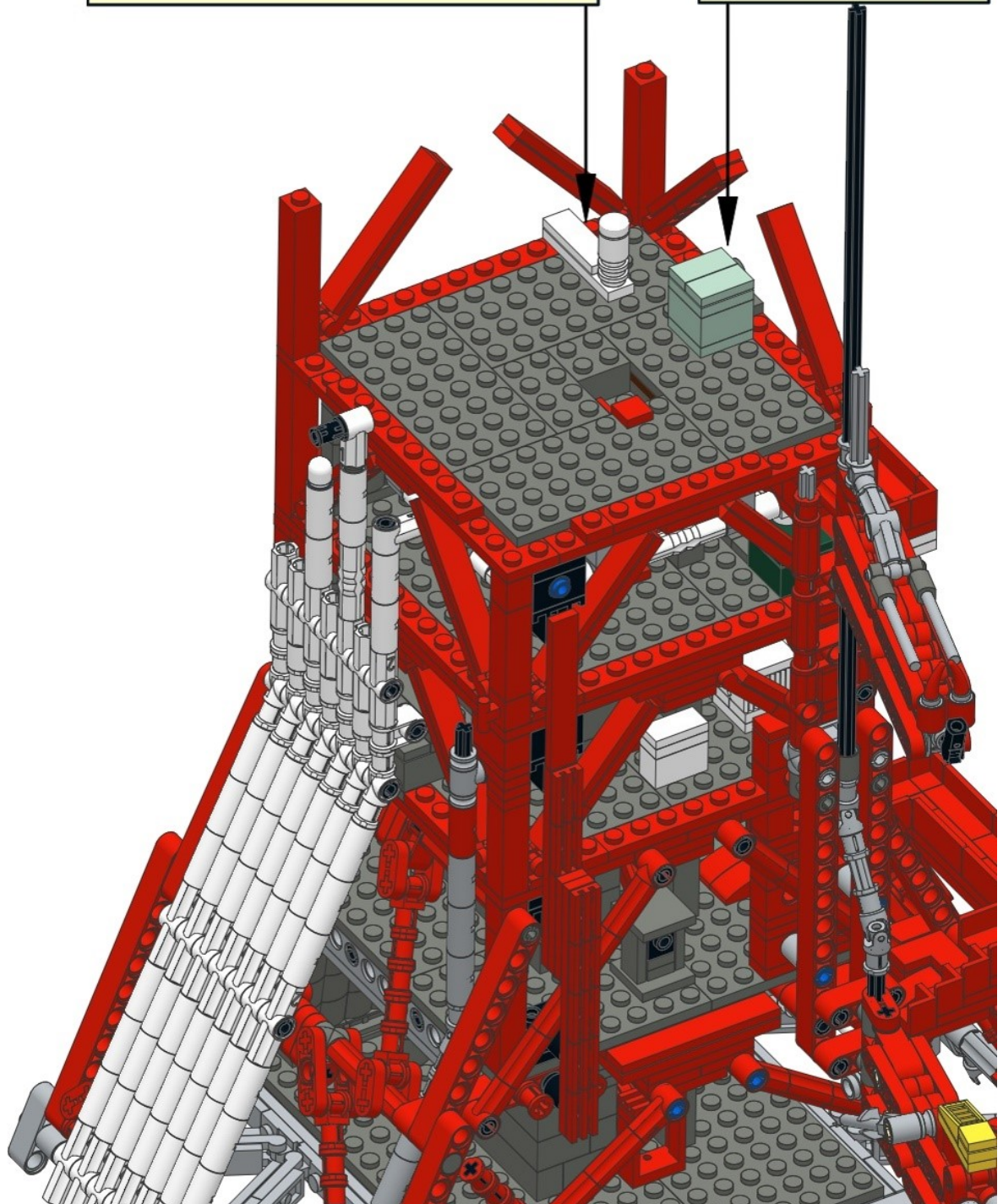
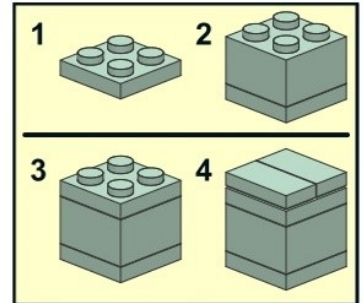
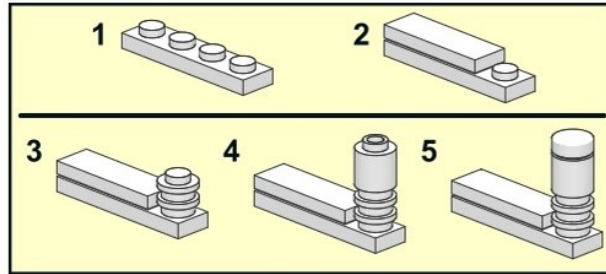
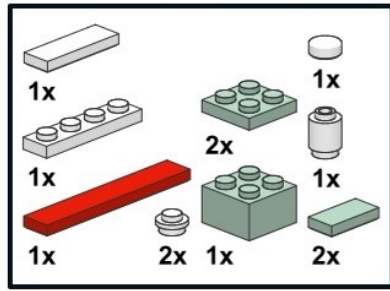



186

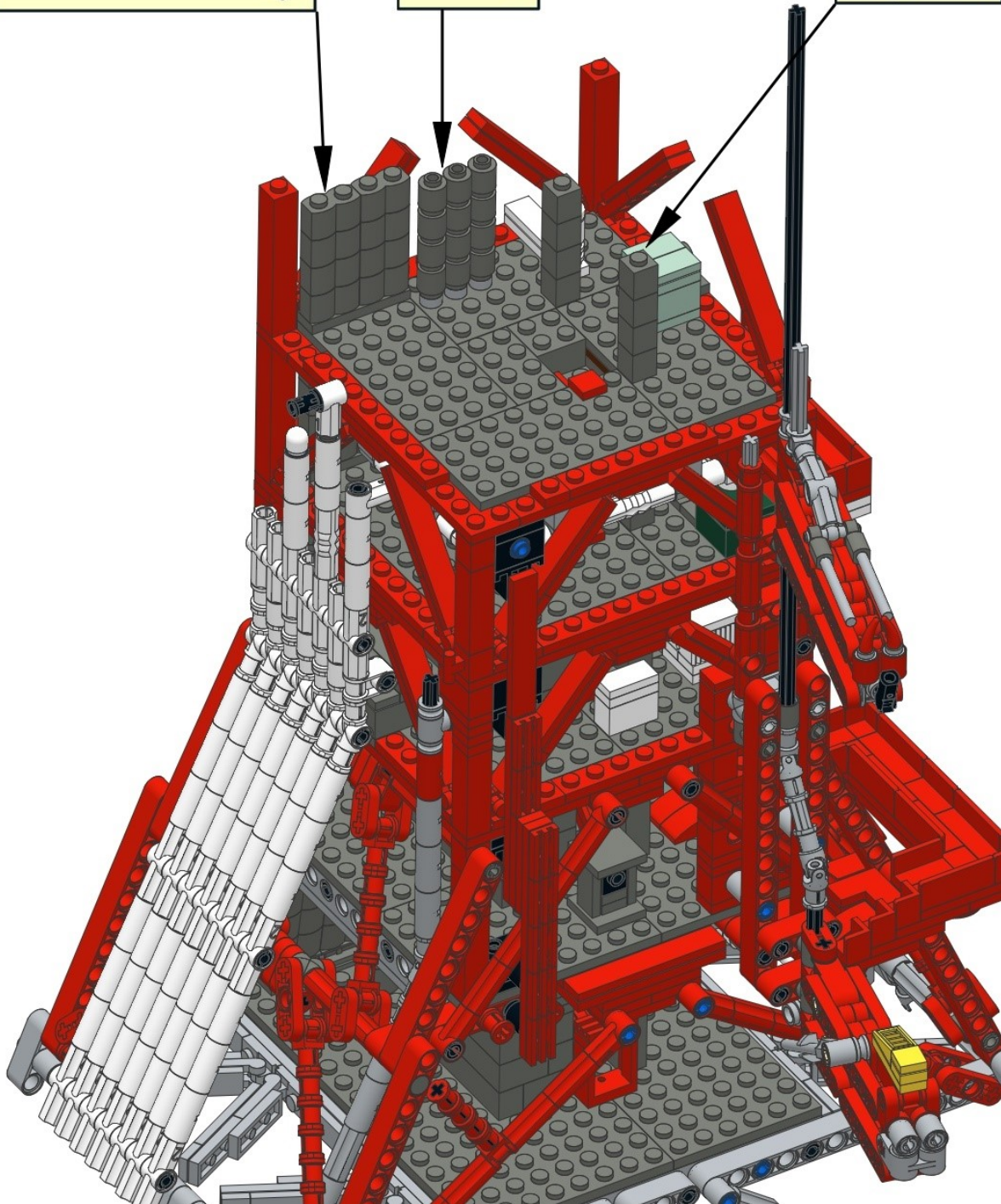
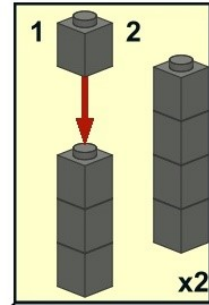
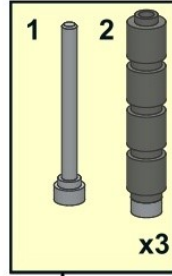
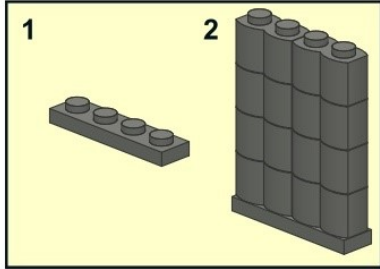
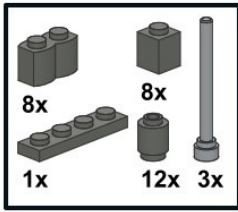

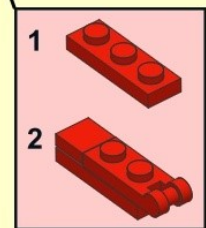
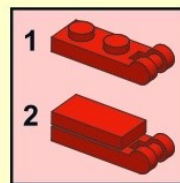
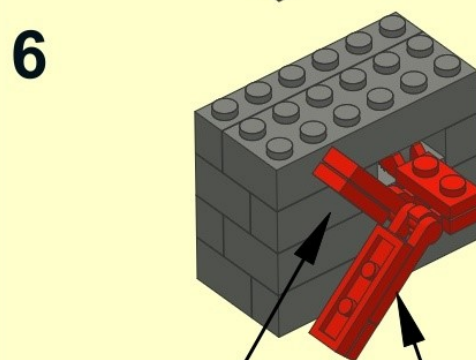
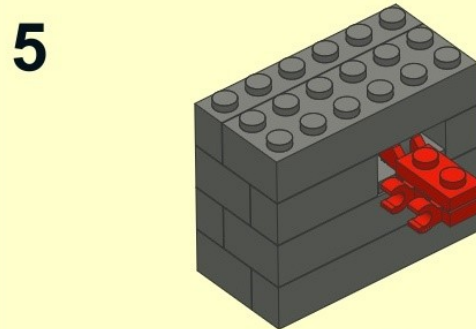
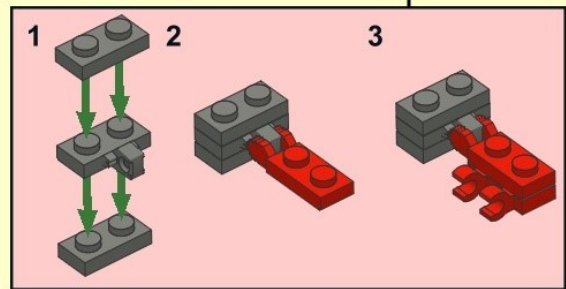
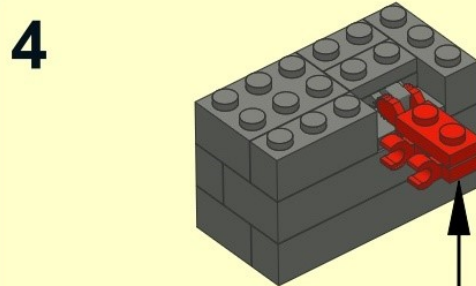
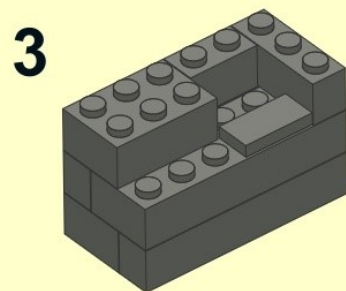
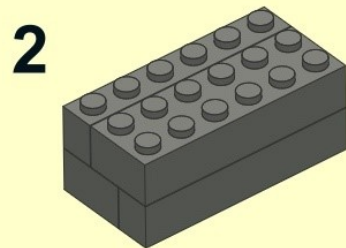
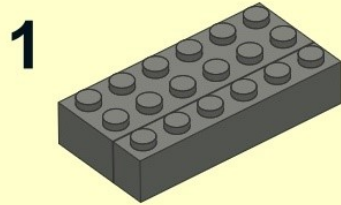
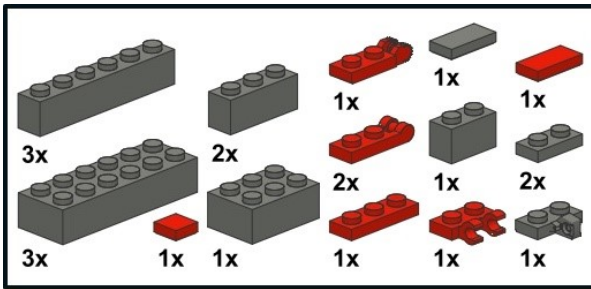



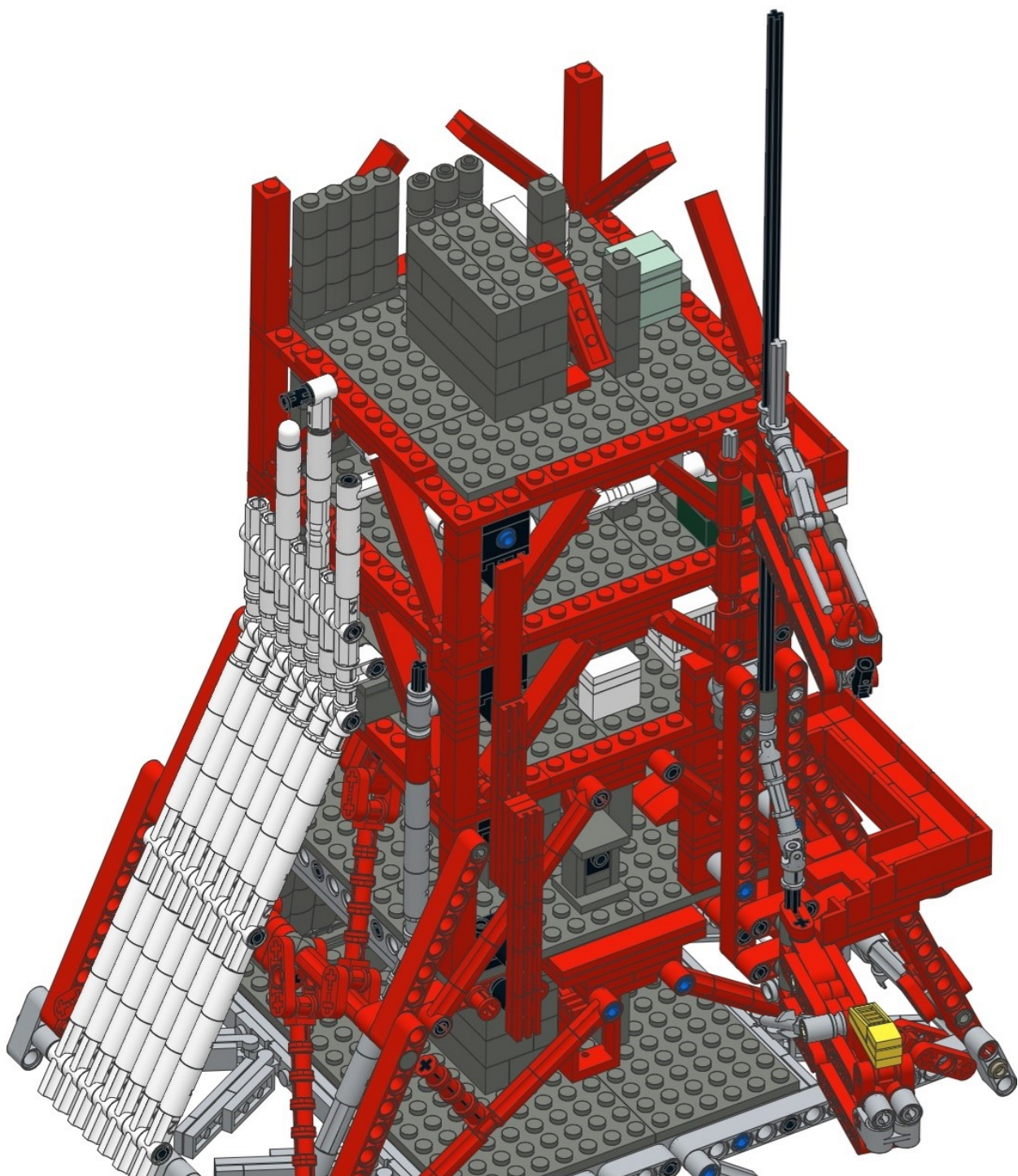

188

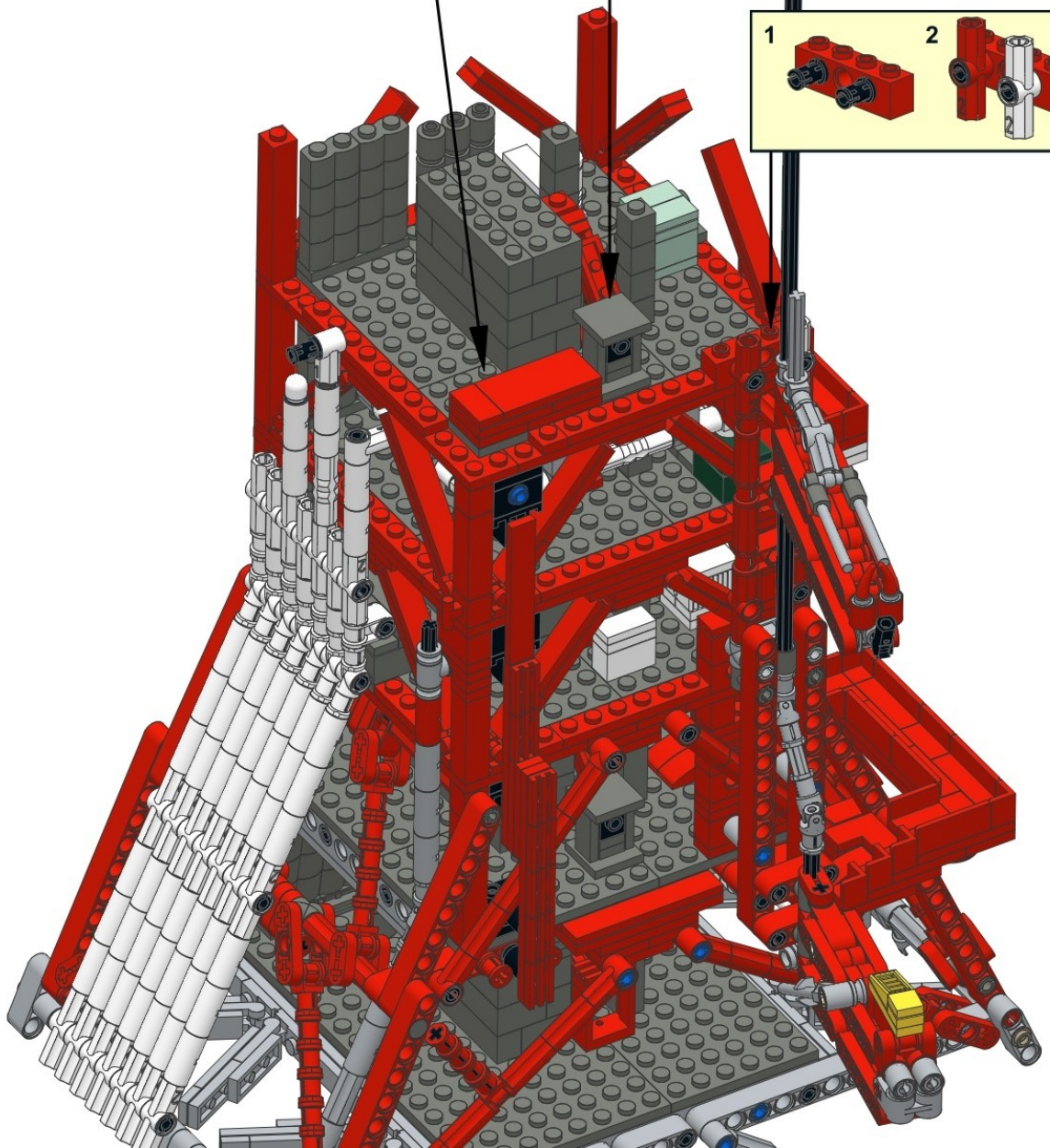
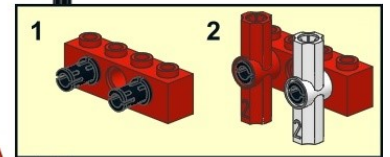
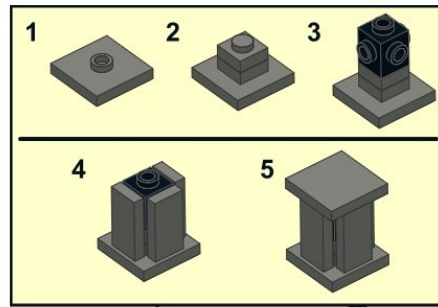
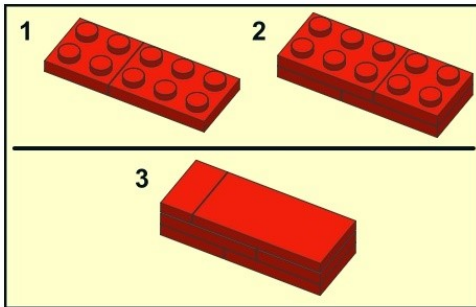
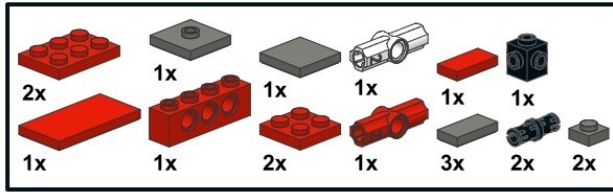



189

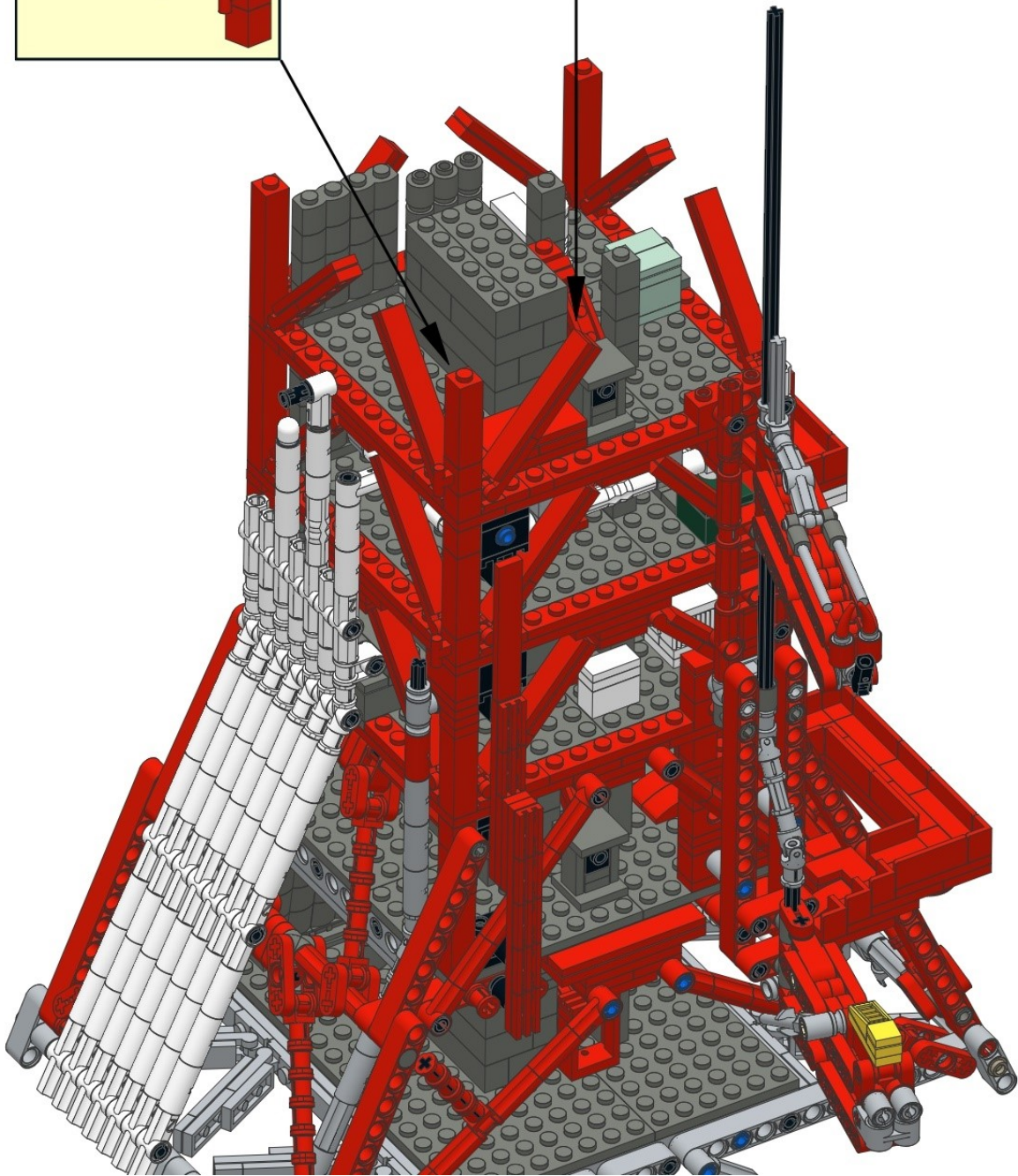
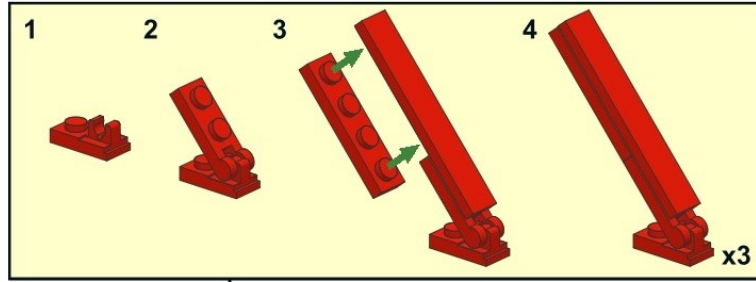
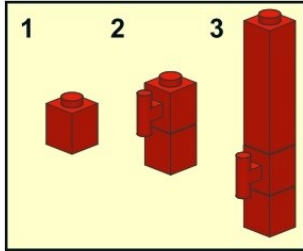
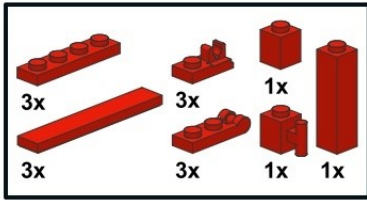

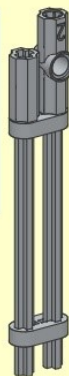
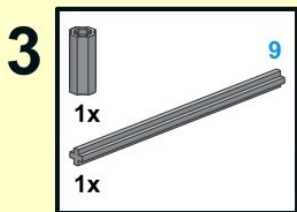
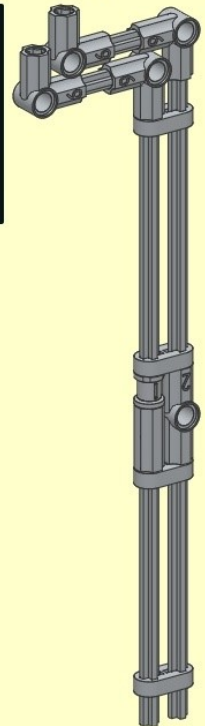
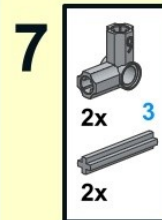
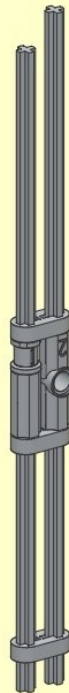
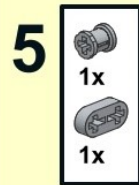
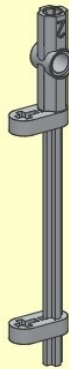
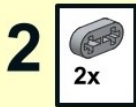
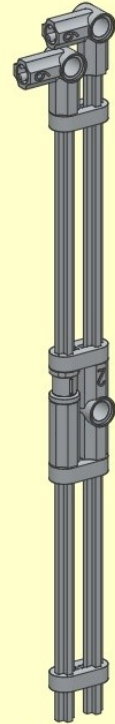
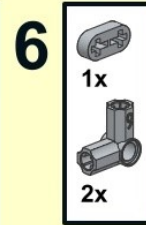
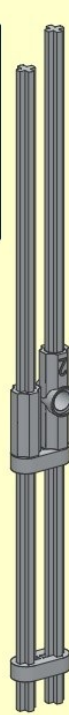
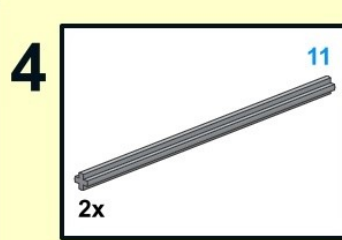
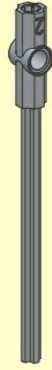
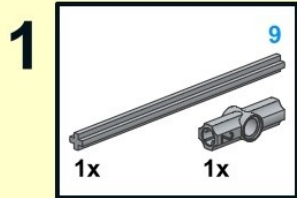



8

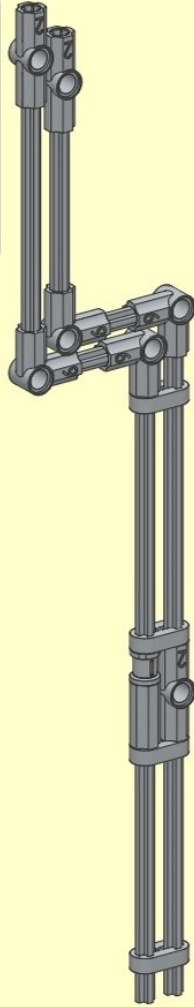
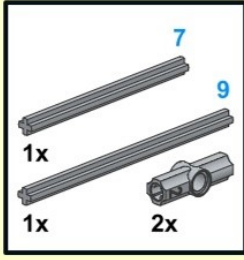

9

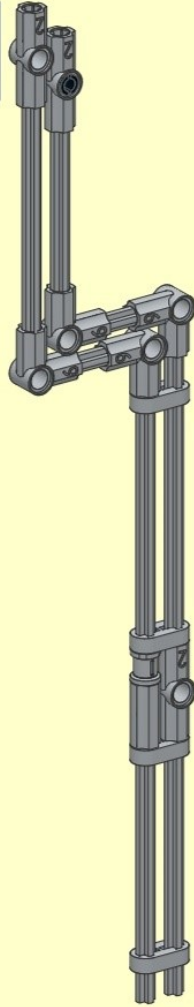

190

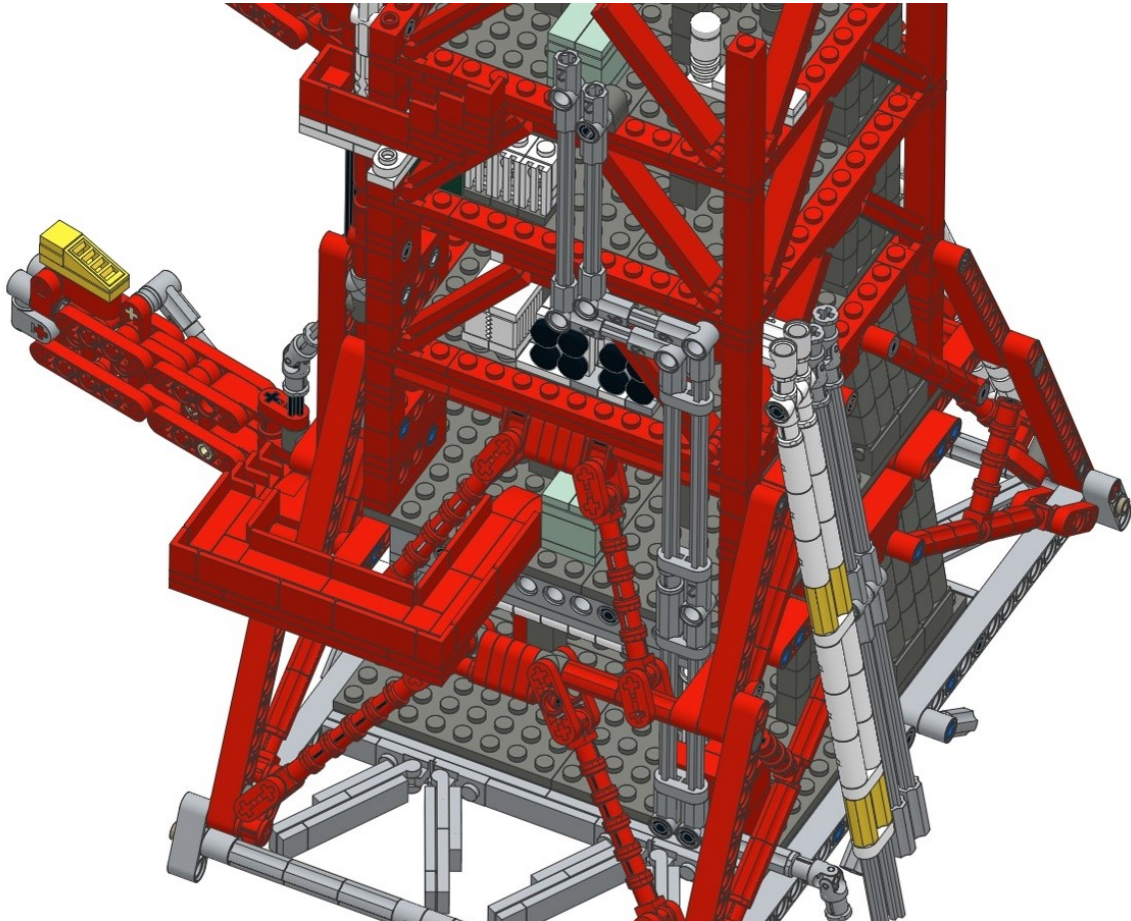

191

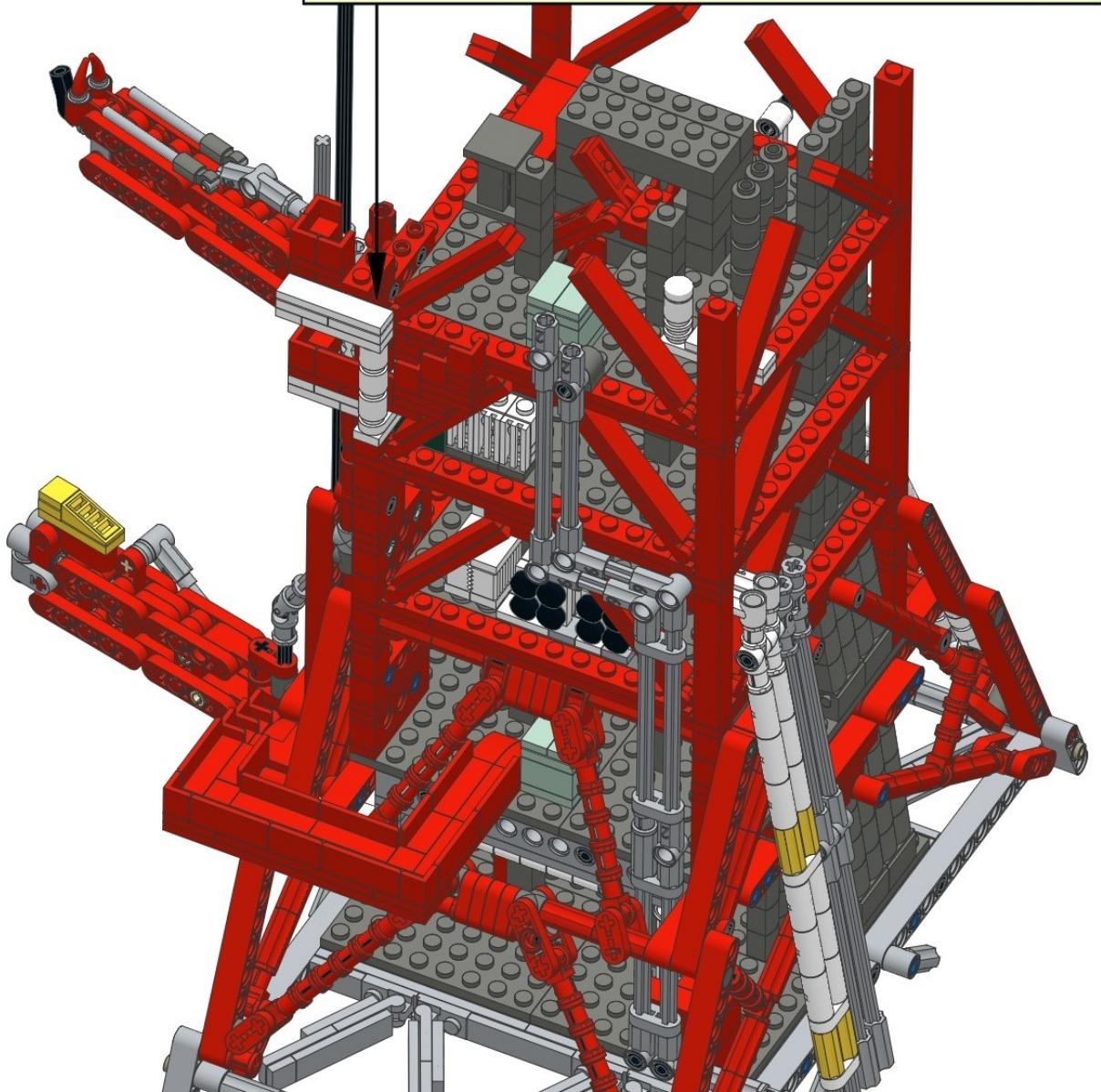
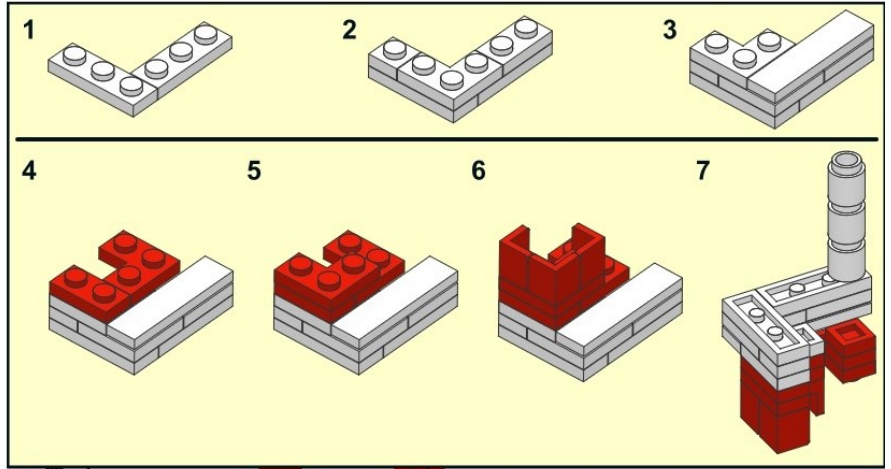
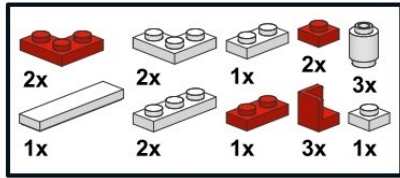



1

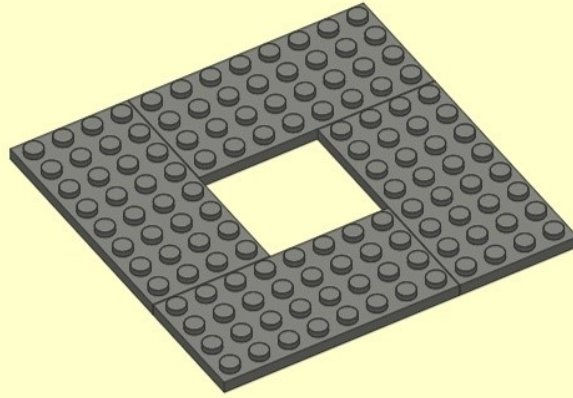
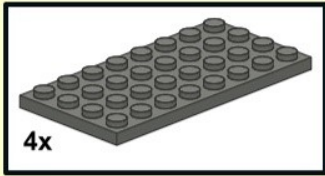

2

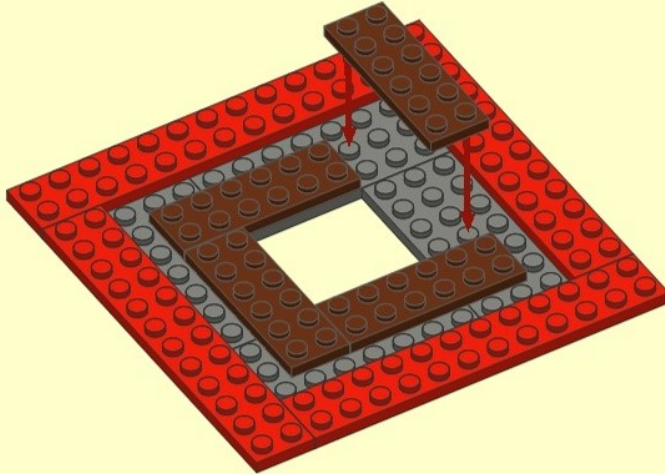
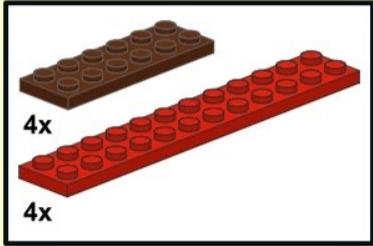

3

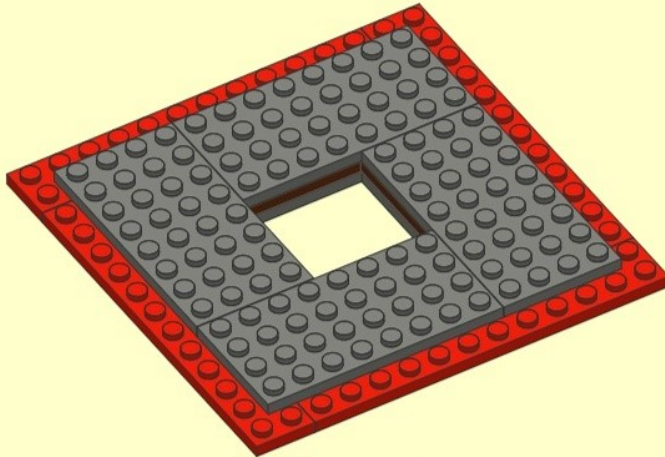
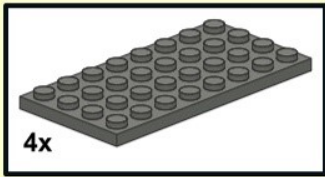

4

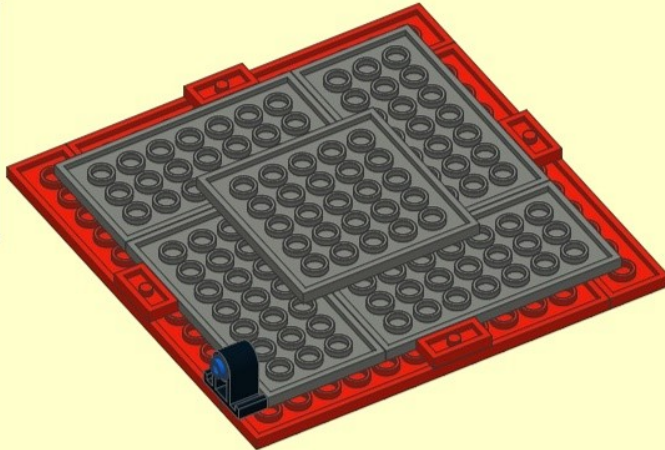
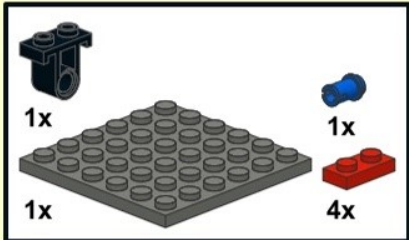

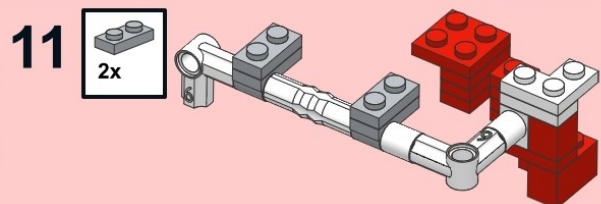
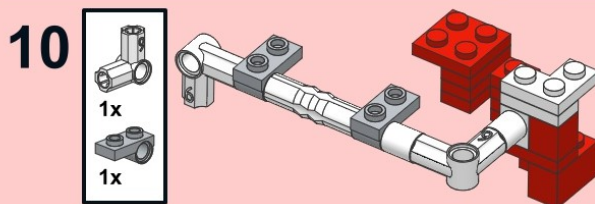
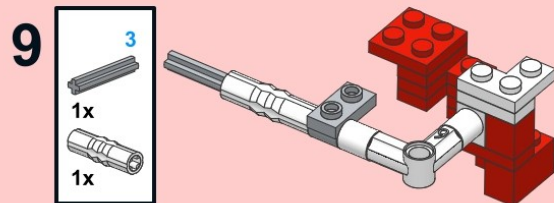
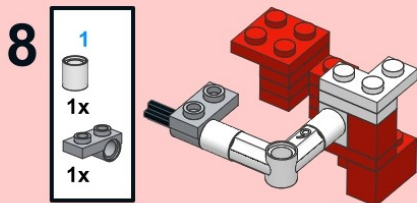
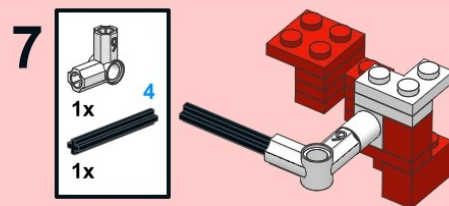
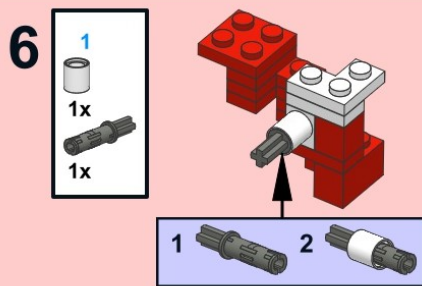
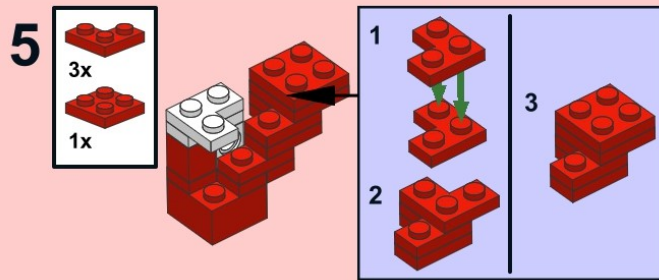
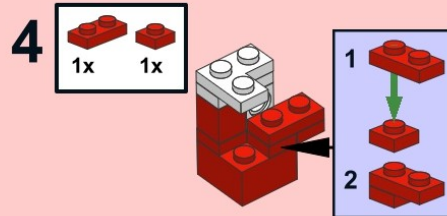
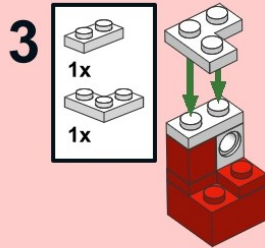
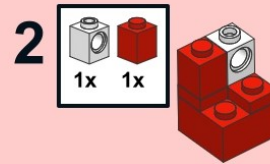
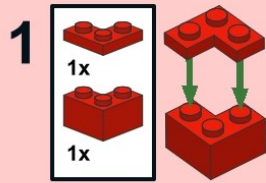



5

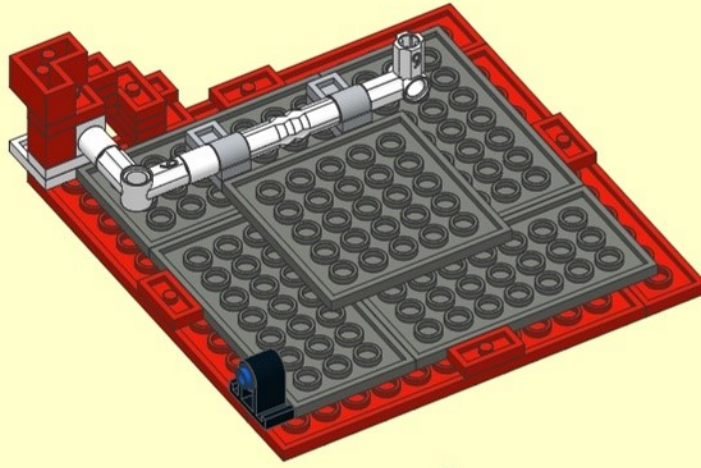

6

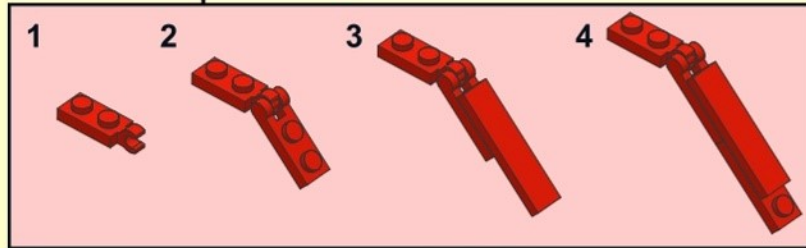
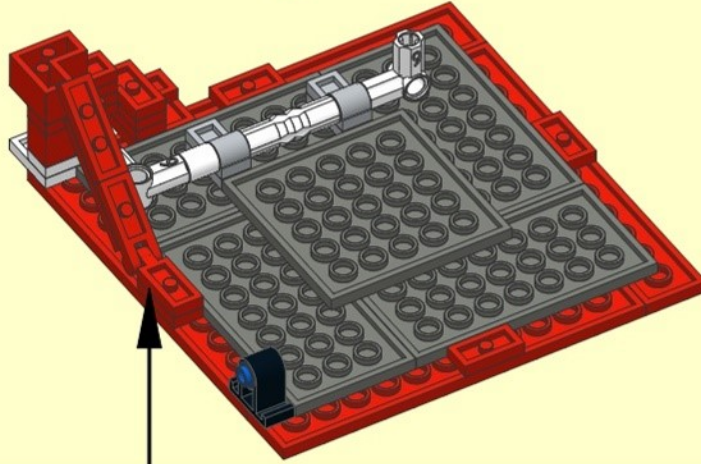
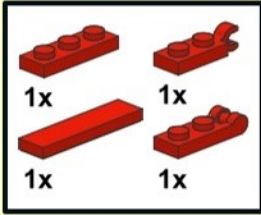

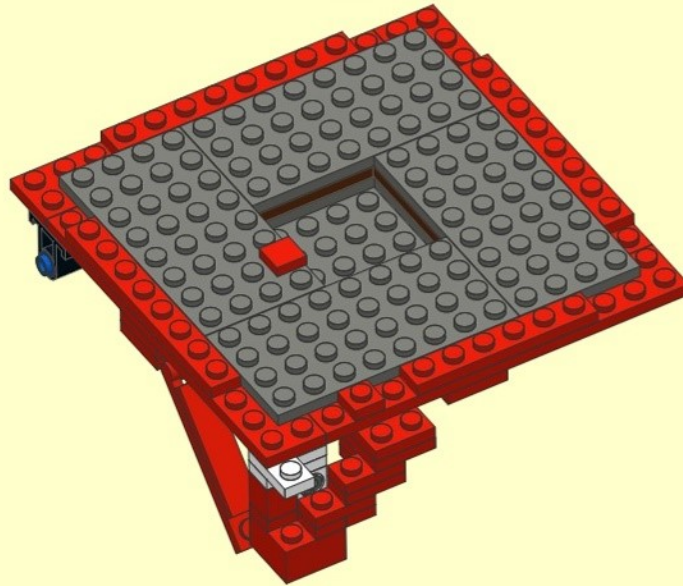
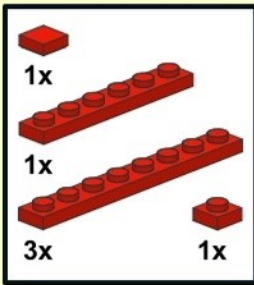

7

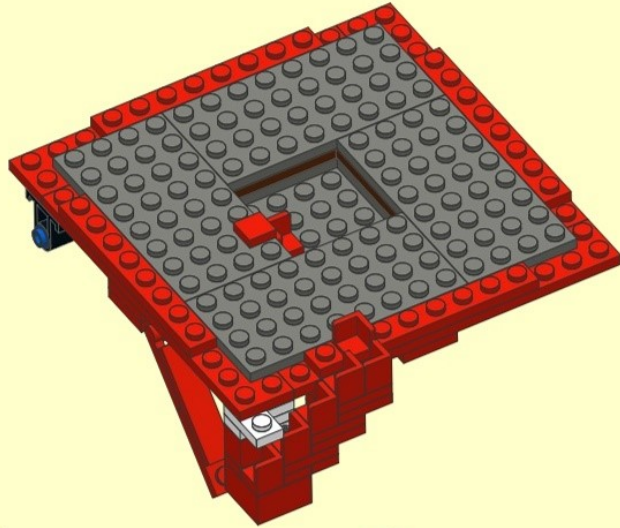

8  7x

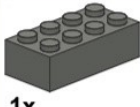

9  1x  1x

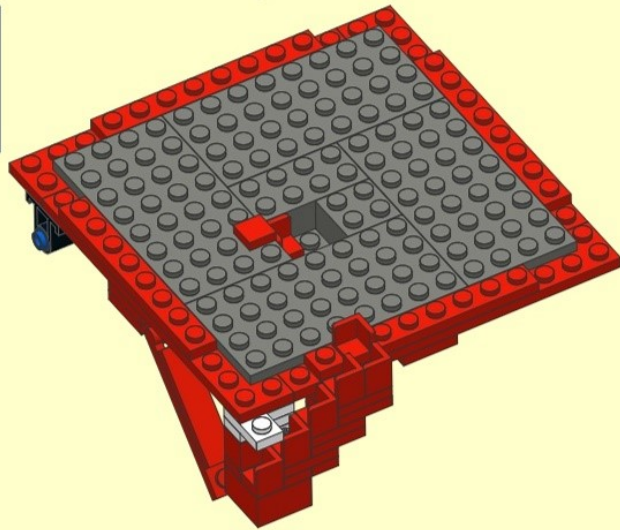

192

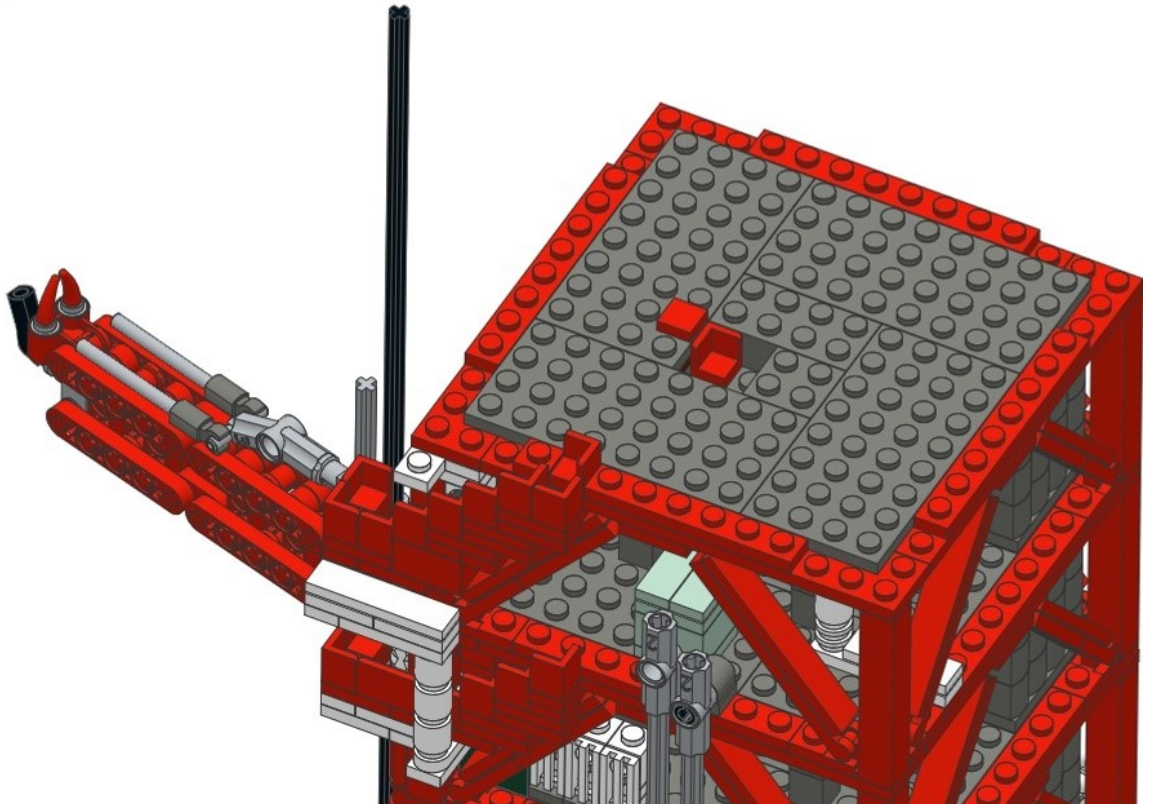



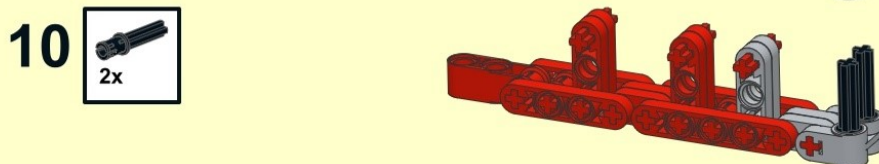
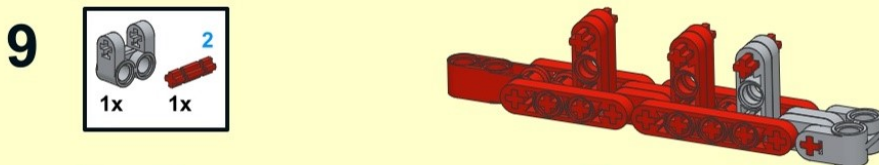
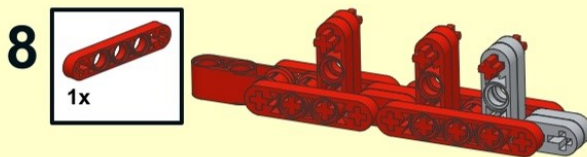
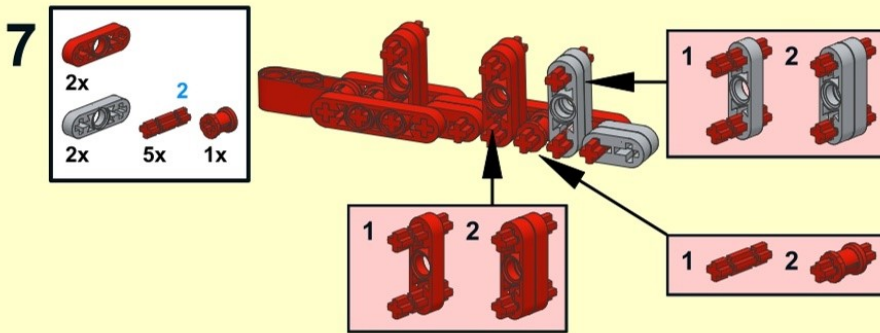
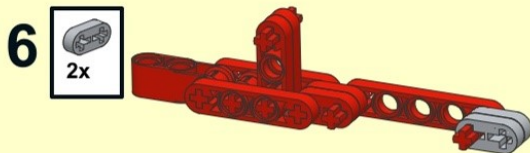
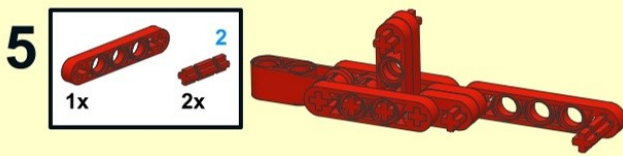
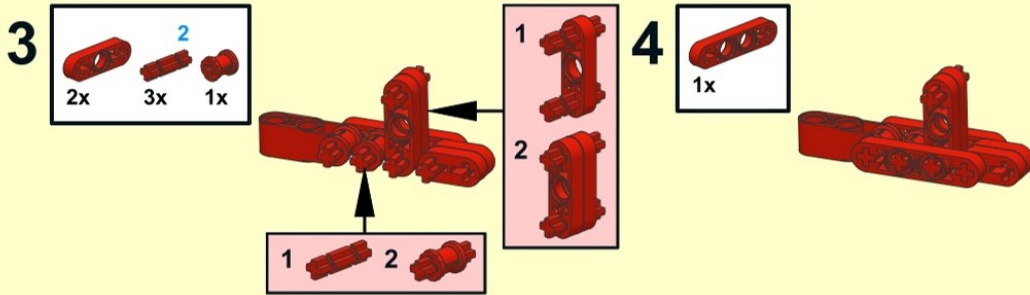
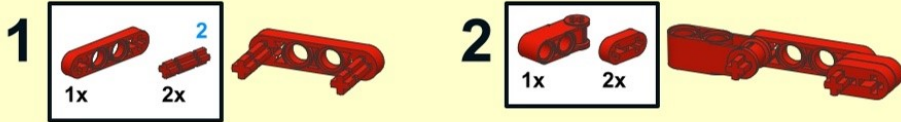

11  2x

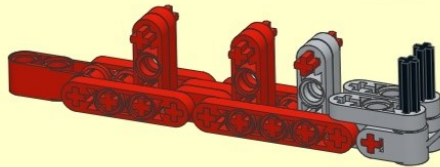

12  2x

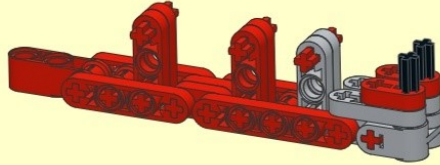

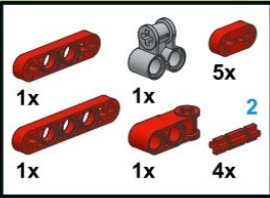
13  1x 1x 5x 1x 1x 2 4x

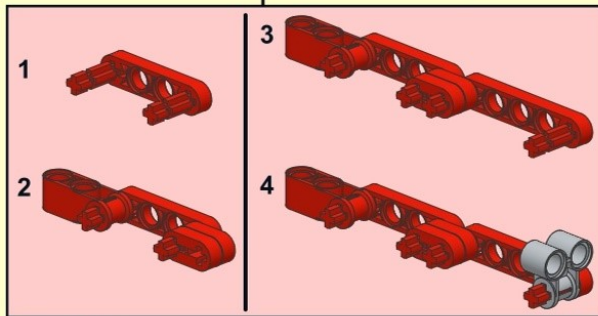
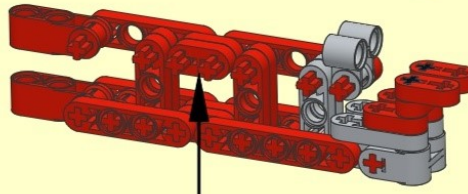

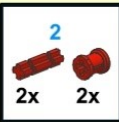
14  2 2x 2x

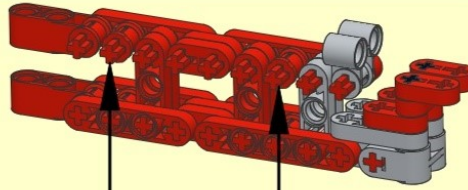

 1 2 x2

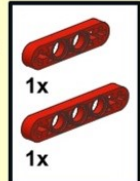
15  1x 1x

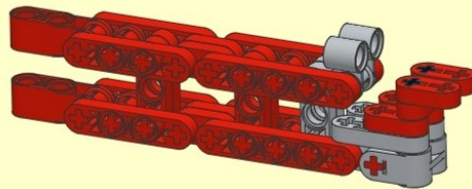

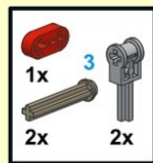
16  1x 2x 3 2x

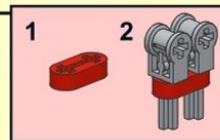
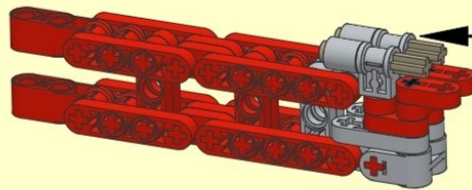

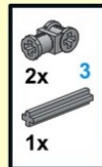
17  2x 3 1x

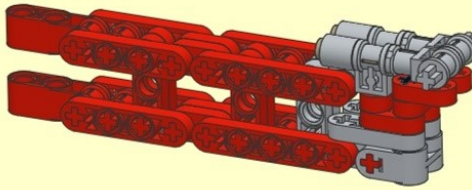

18  2x

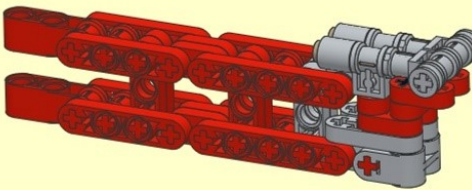



19

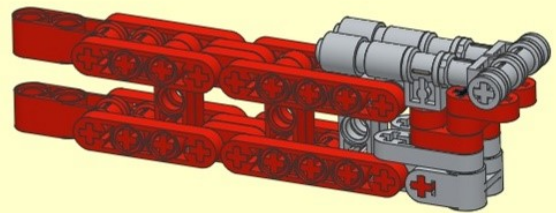
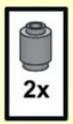

20

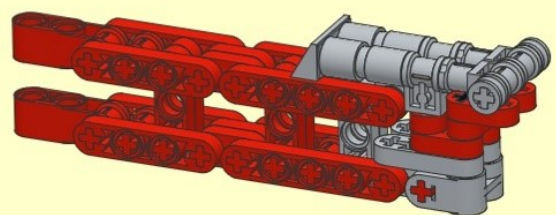
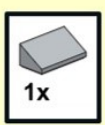

21

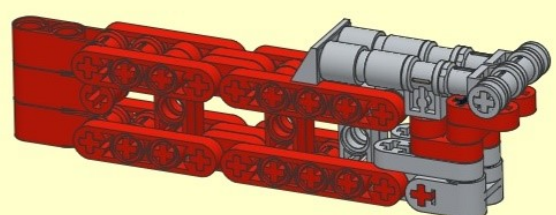

202

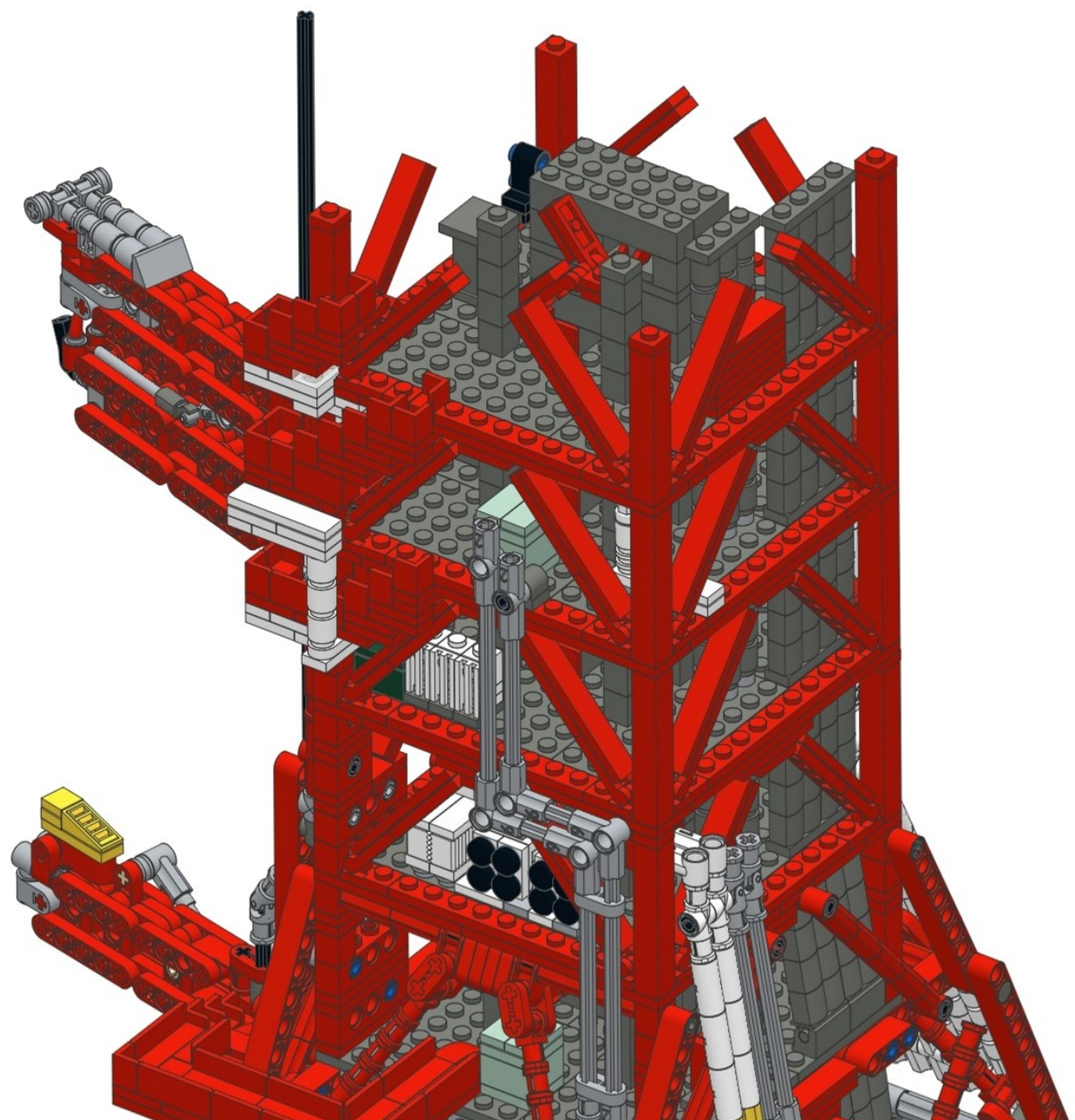

1

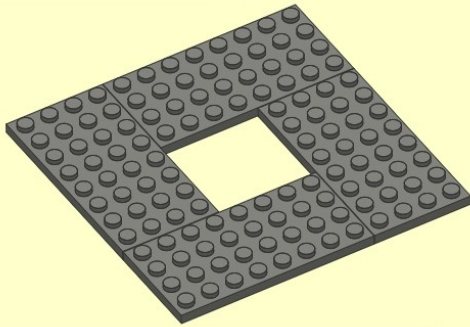
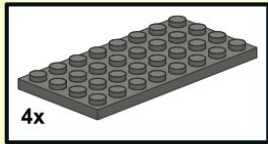

2

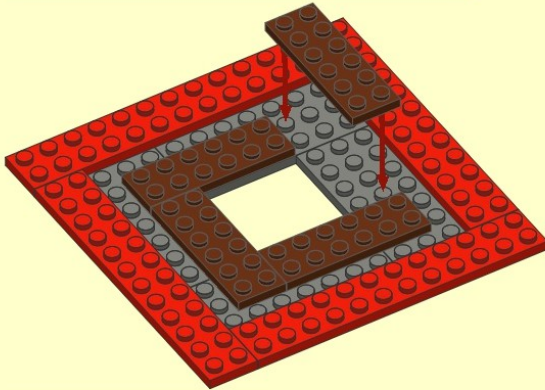
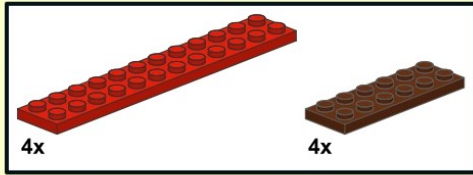

3

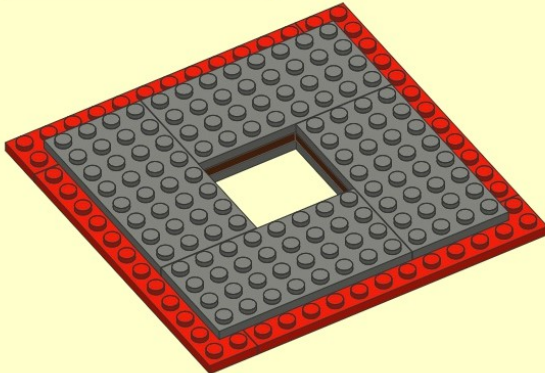
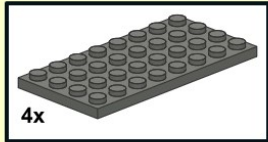

4

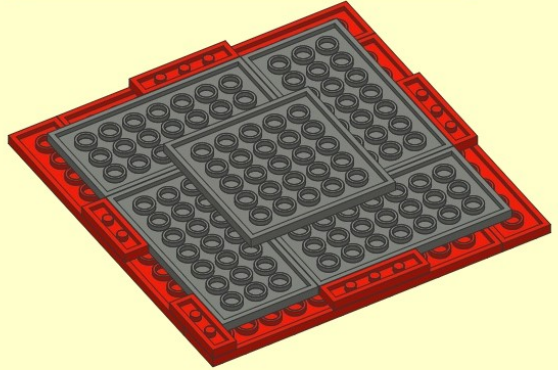
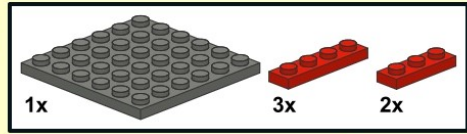

5

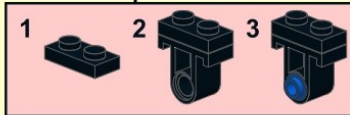
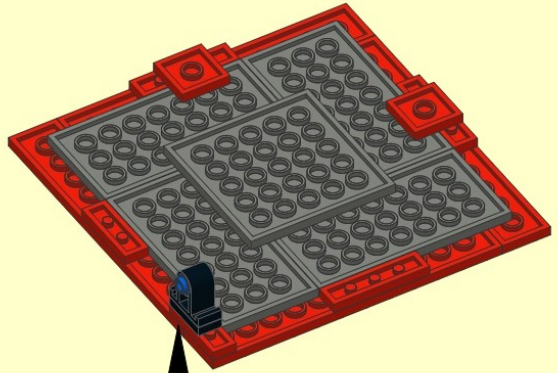
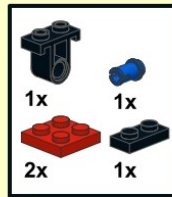



**1**

**2**

**3**

**4**

**5**

**6**

**7**

**8**

**9**

6

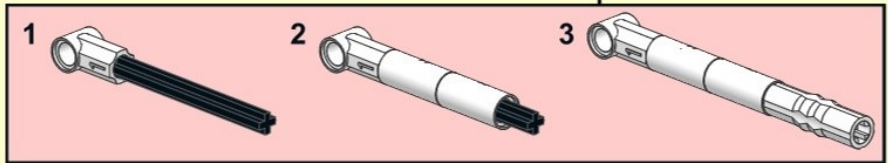
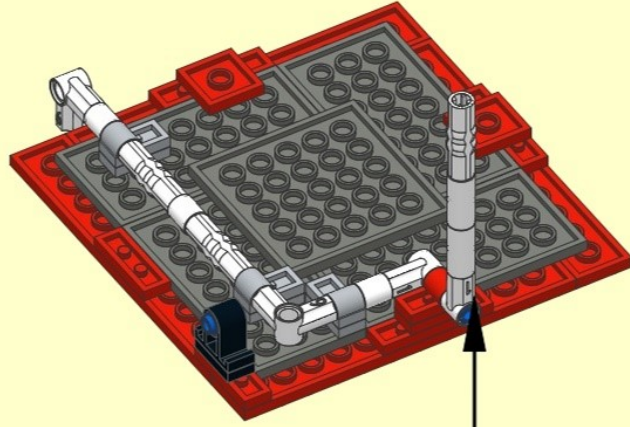
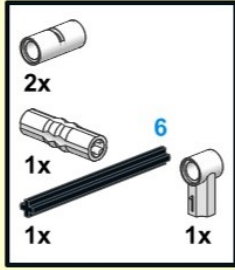

7

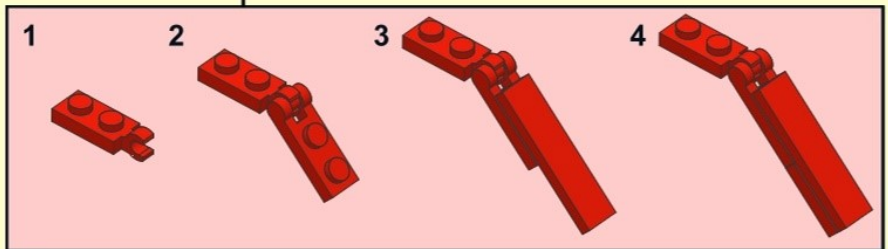
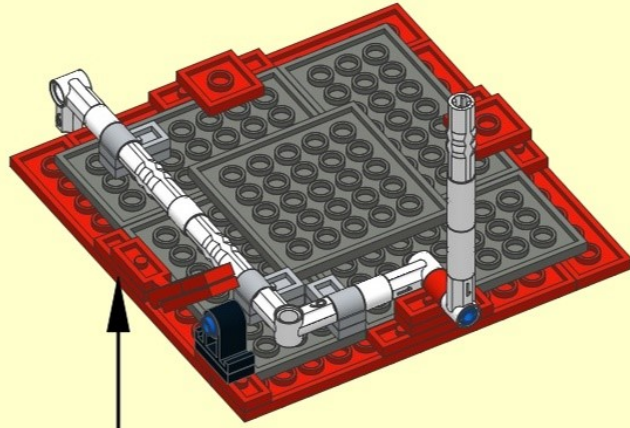
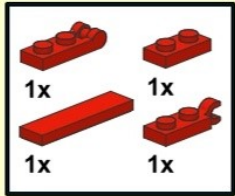

8

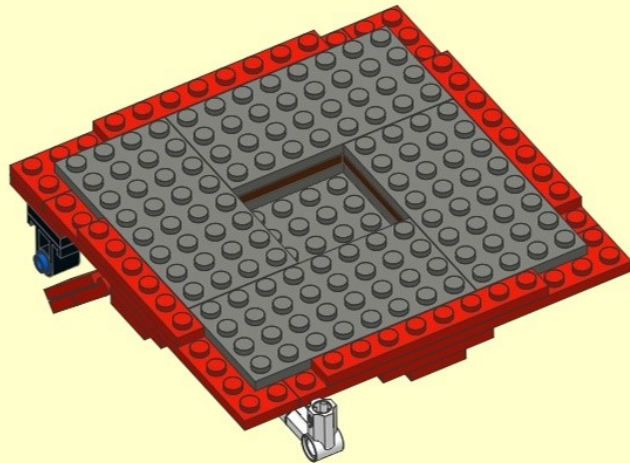
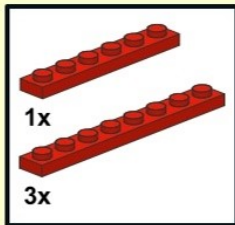



9

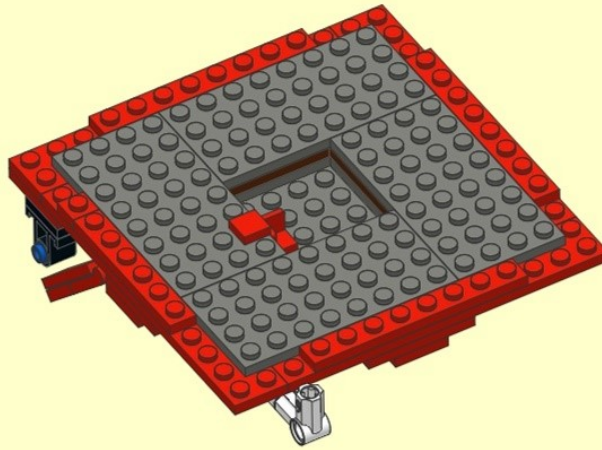
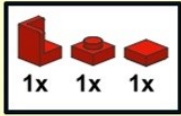

10

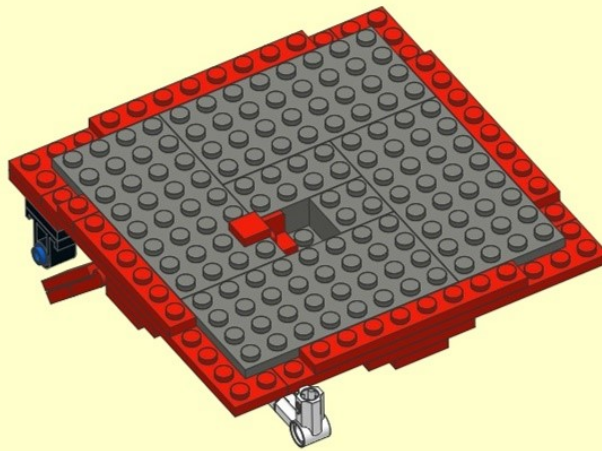
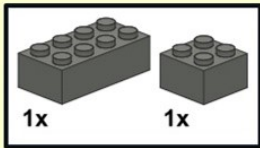

11

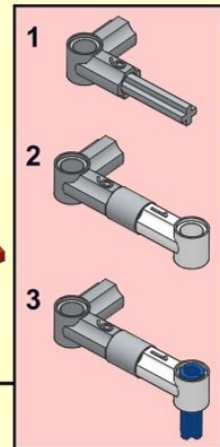
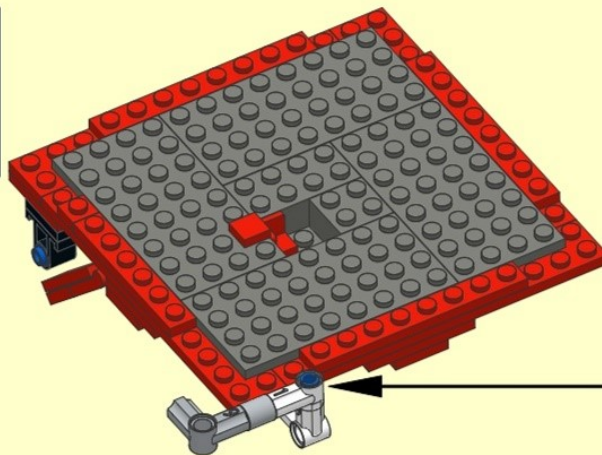
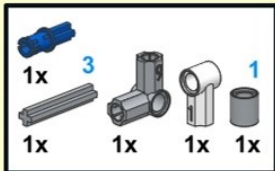

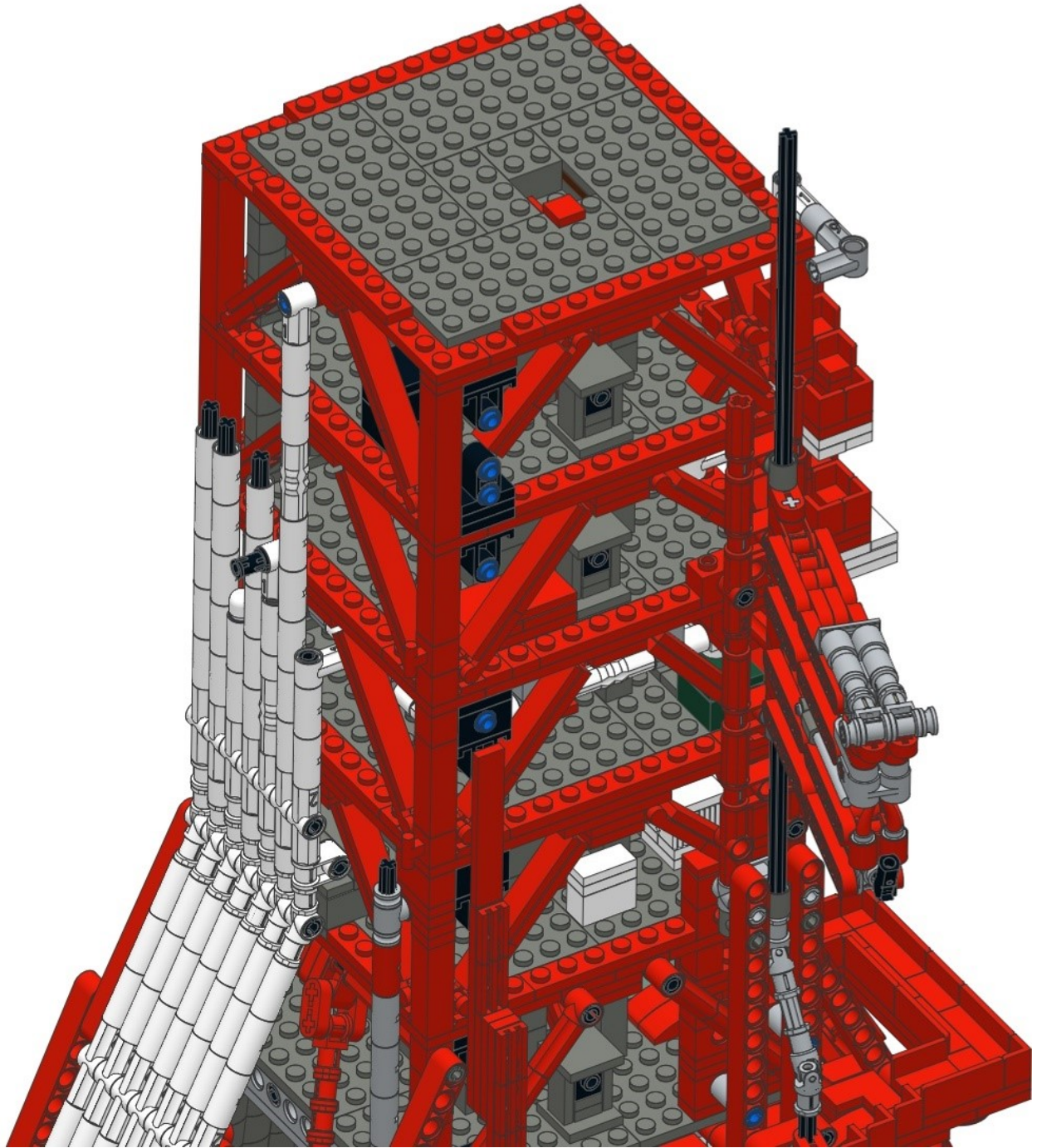

Instructions continue in part II of Vol III, Bricks in Space









# Bricks in Space—Vol III, Part 1: The LUT

The perfect match to the Saturn V Lego model and the only place to launch it from is of course the Launch Umbilical Tower from Launch Complex 39A at Cape Canaveral. Volume III of “Bricks in Space” presents a detailed model of the LUT scaled at 1:110, complete with moving arms and crane and exactly the right dimensions to fit the Saturn V model.

