

## FOREWARD

This rocket build would not have been possible without Grant Passmore's original Saturn 1B 1st stage design. It also would not have been possible without the catalyst of Nathan Readoff's spinoff of the rocket trying to get the thrusters into the right positions. As much as I did some work here, these people were the catalyst of inspiration that took it to as accurate as I could possibly get it.

I highly suggest the DVD set from <http://www.cgpublishing.com/> It consists of 6 dvds that are part of a book combination on the Saturn 1/1B. These can be kind of pricey with the books but if you call the, you probably will be able to get the dvds. Make sure you try to get the "1st" one from the book. They might just sell all of them to you for a nominal fee.

If you have questions, send to my email at davidwells44@yahoo.com. Subject: Saturn 1/1B I will also take paypal donations at the same address for I did spend a bit of money researching this project.

## DESCRIPTION

The Saturn 1B rocket series rocket was the second series of what was considered a heavy lifter that became more of a moderate lifter. Following the Saturn 1 series a number of changes happened. The first stage had the stub wings/wings completely redesigned. It was found that the vibrations on the original design were not man flyable. It would have killed the crew. A result of this redesign did save some weight. Another change that affected the 1st stage was a change of the second stage.. They dropped the S-IV stage for a S-IVB stage using the H-1 engine. It was more powerful and allowed the elimination of the H2 chill down ducts on the side of the 1st and 2nd stage. This save even more weight.

Originally the Saturn 1 series was going to be called Juno V, but became apparent a new name would be needed due to confusion. NASA sourced existing proven technology to make it work and use the existing infrastructure instead of starting from scratch. The Saturn 1B became the test bed afterwards for what would be used on the Saturn V. Various flights tested the LEM, CSM, and S-IVB. Later the platform would send astronauts to skylab and the final mission of apollo-soyuz. There were other plans for the Saturn-1B but that information will be published in a different publication in the future.

S-IVB 200 vs 500 series. The S-IVB had two different series. The 200 was the one that was mounted on the Saturn 1B and had 3 ullage motors. It also only had 1 helium tank for pressurizing the other fuel tanks. It was never intended to be fired multiple times and all that was different to allow this was a valve change. The 500 series was on the Saturn V series and only had 2 ullage motors. It also had 7 helium tanks for fuel tanks pressurization. Obviously it did have the valve for the 2nd firing for trans lunar injection. Originally the payload bay petals were designed to open up and stay attached to the stage, but Apollo 7 encountered a problem where 1 petal didn't open all the way initially. Subsequent versions jetisoned the petals.

## FURTHERE INFO

Instrument Panel: This was the section of the computers and various gyros to control the rocket's flight

Ullage Motors: These were used when the 1st stage seperated from the 2nd stage. They would fire to settle the LOX and LH2 while pushing the 2nd stage furthure away from the first.

APMs: Auxillary Propulsion Module. These were used to orient the S-IVB stage and provide an extra push to settle the cyrogenic fuels. This was only really done in one of the tests for the a second firing that would be done on Saturn V missions.

Retro Rockets: These fired when the 1st stage separated from the 2nd stage. They pushed it "down" away from the 1st stage.

Telemetry Antennas: These were used to help guide the rockets and also allowed the ground to receive data on the condition of the rocket

## INSTRUCTIONS

In regards to the instructions. They are divided up into sections to allow the building of all versions of the Saturn 1. Part lists are for each section and must be combined into their own respective lists. Some models might require removal of parts from a list and additions added due to details bits. Mainly this will be in the SA-1 to SA-4 series. I suggest studying them before any kind of parts order be made on the secondary market.

## FUTURE PLANS

Future revisits are planned to this document. There was a Saturn 1 setup at a museum that looked different due to the fact that it was actually a test platform. This would be a great addition to Grant Passmore's rocket garden. Plans are being made to add that rocket and a stand for it (and others) to this document, but I currently want to focus on other projects.

There are 2 glaring issue/mistakes. The Lego Saturn V has a too large LES and that was kind of carried over to other models by the community. Eventually an addendum will be added to correct this problem. The other is the checkering on the SA-1 thru SA-4. It needs to be down lower on the larger ring of the dummy 2nd stage. The idea of doing it the way is to not do stickers. Since I have no experience with them at this point, it is acceptable, but if one want to do stickers, it isn't hard to figure out what parts would replace what.

## ----- INDIVIDUAL FLIGHTS AND SECTIONS TO BUILD

SA-201 thru SA-204 will be published in future

SA-205 aka Apollo 7 Marks the beginning of the first manned launch. They conducted many tests with the CSM, rendezvous with the S-IVB stage, "dock" with the S-IVB stage, and other small tests.

To build this rocket use section:

SA-206 thru SA-209 aka Skylab 1-3 (4 rescue flight) Marks the use of the Saturn 1Bs that were put in storage for about 3 years. There was a 4th Saturn 1B that was built up in the case a rescue mission needed to be done with a specialized CM that sat 5 people.

To build this rocket use section:

SA-210 aka Apollo Soyuz A successful mission of docking with a Soviet Soyuz capsule. No instructions for this right now, but very similar to Skylab's version. The payload section contained the docking module. Instructions are not included in this version but will be in the future. Nico Daams has made some for the module.

SA-205  
Apollo 7



SA-206+  
Skylab 1-3

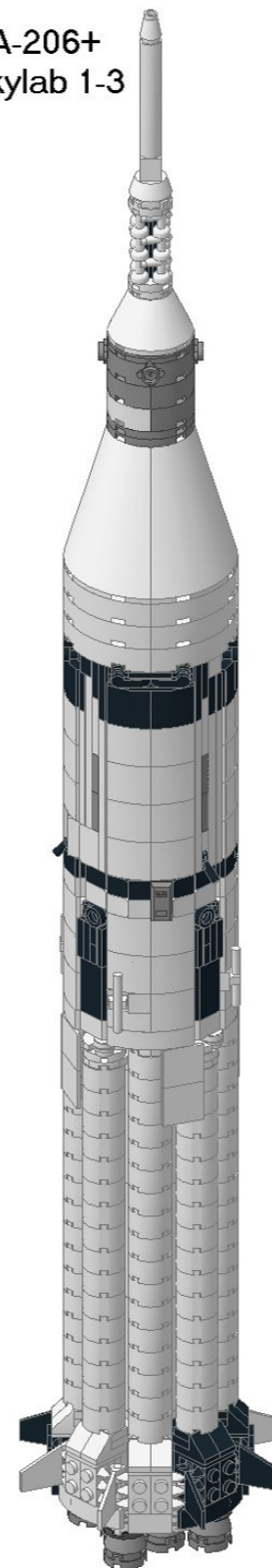

- Ullage Motor (3)
- Auxillary Propulsion Modume (2)
- Retro Rocket (4)
- Telemetry Antenna (4)

Wings (8)

# SECTION A

1

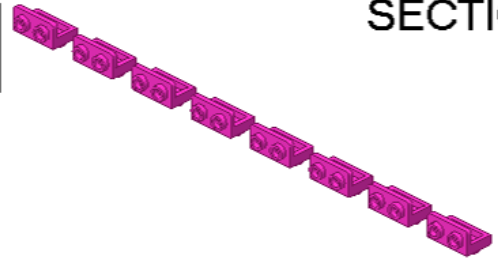

2

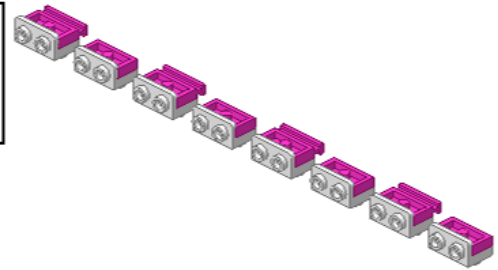
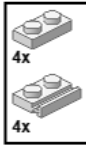

3

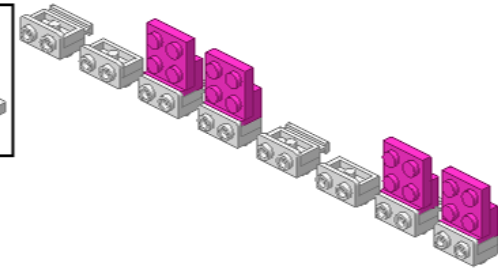
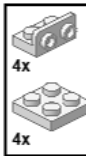

4

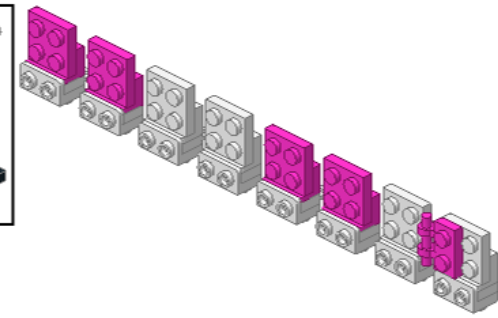
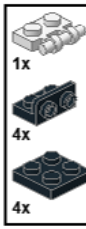

5

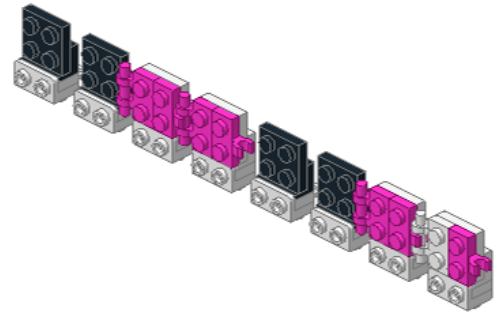
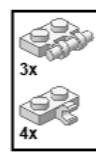

6

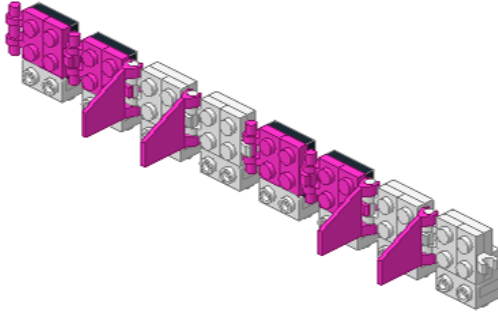

7

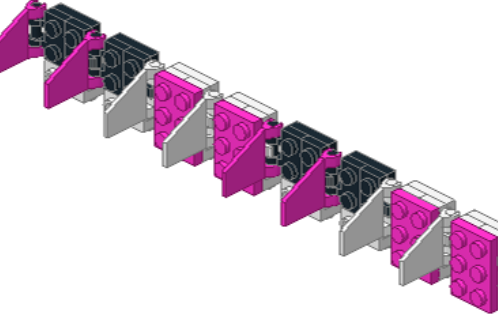
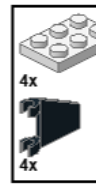

8

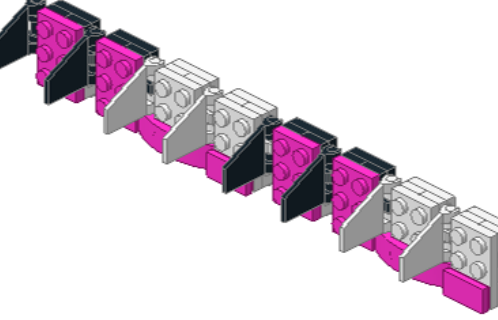
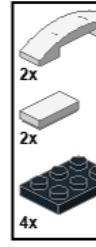

# SECTION A 12

**9**

- 4x
- 2x
- 2x

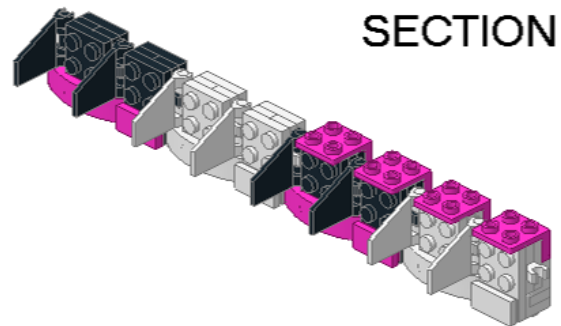

- 4x
- 1x
- 1x
- 1x
- 4x
- 3x
- 3x

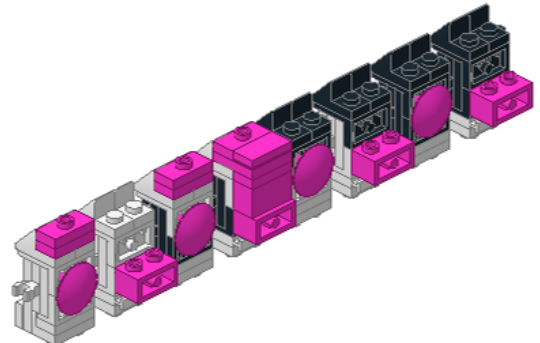

**10**

- 8x
- 4x

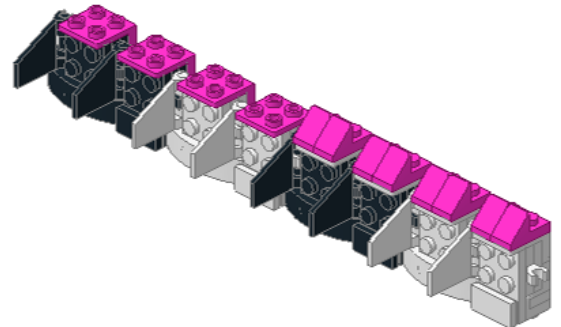

**13**

- 1x
- 1x
- 3x
- 3x
- 1x

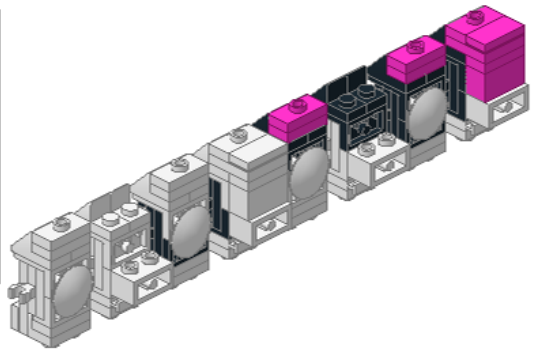

**11**

- 8x

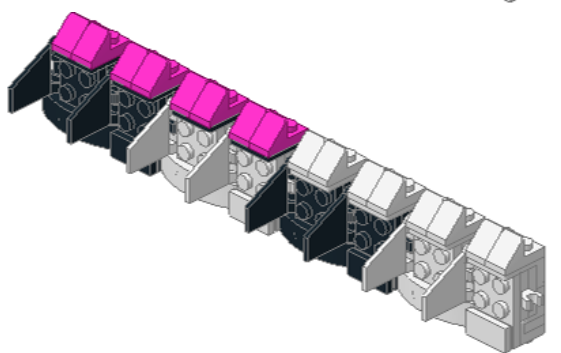



5

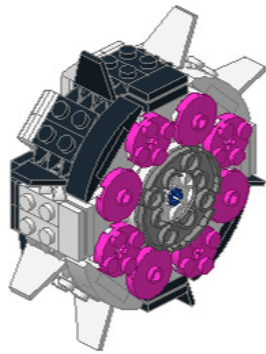

6

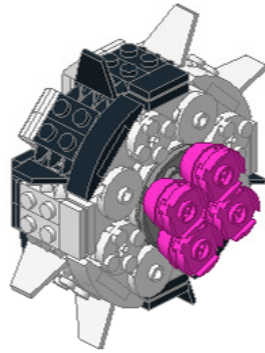
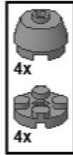

7

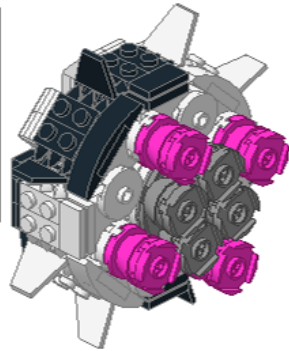
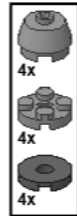

8

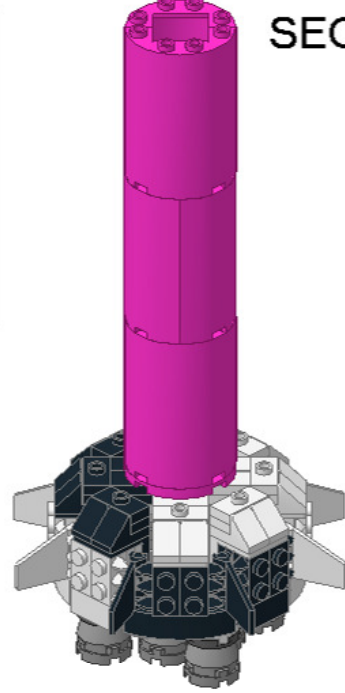
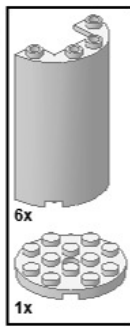

SECTION A

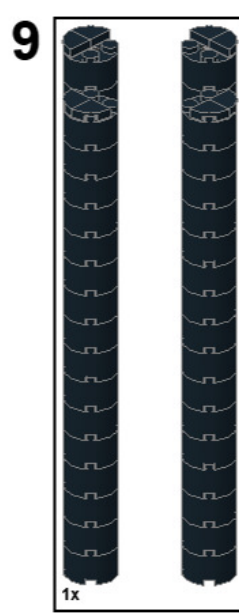
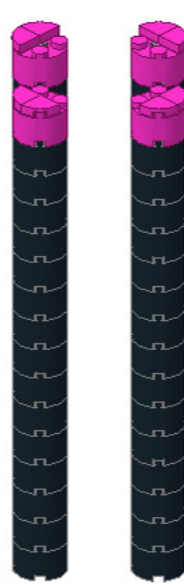
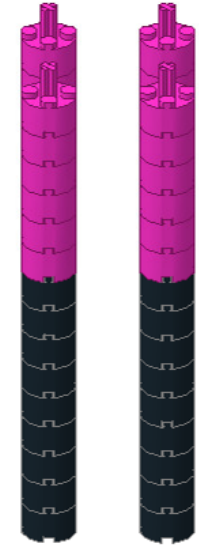
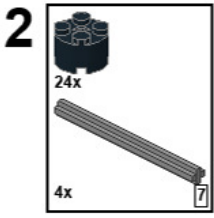
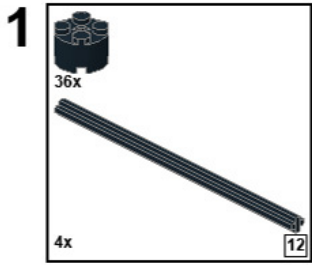

SECTION A

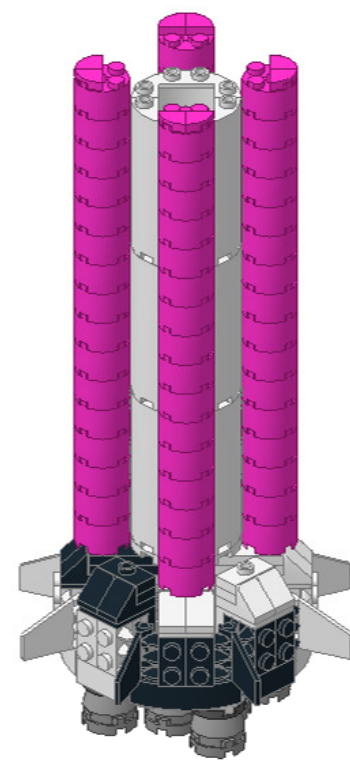



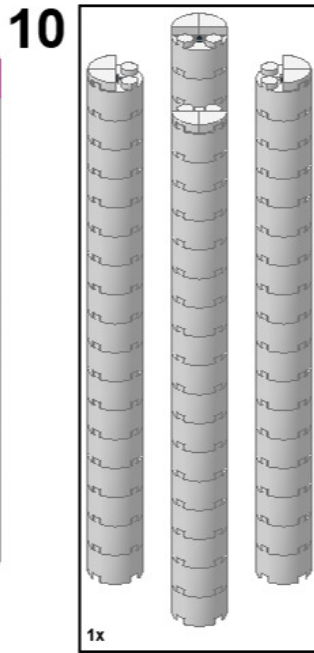
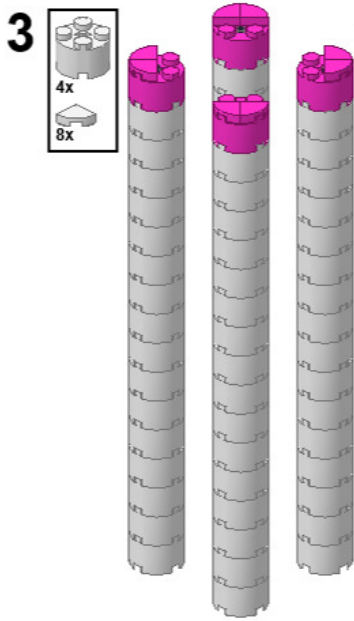
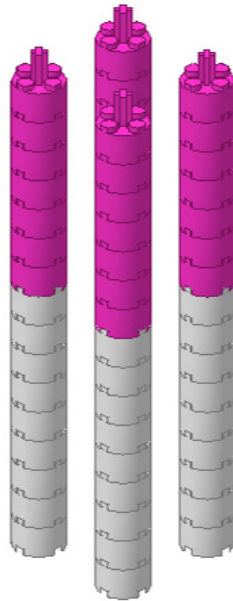
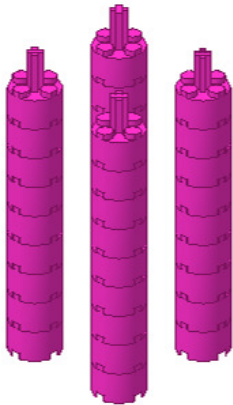
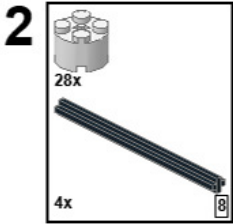
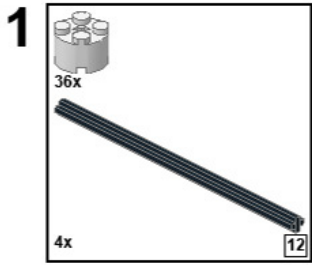

SECTION A

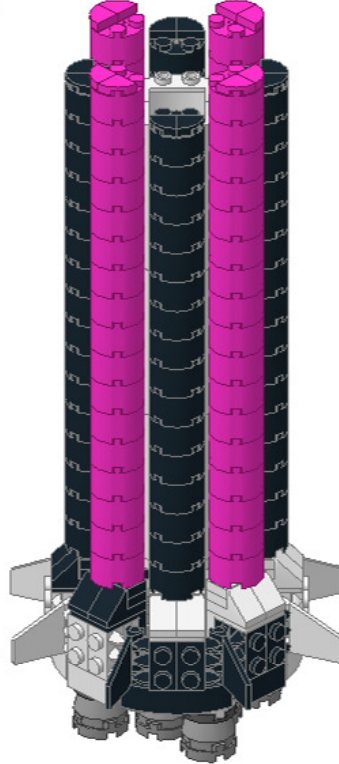

11

SECTION A

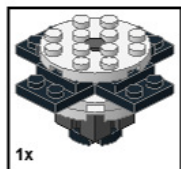

1x

1

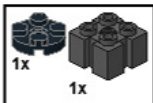

1x

1x

2



2x

1x

1x

3

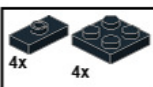

4x

4x

4

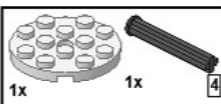

1x

1x

4

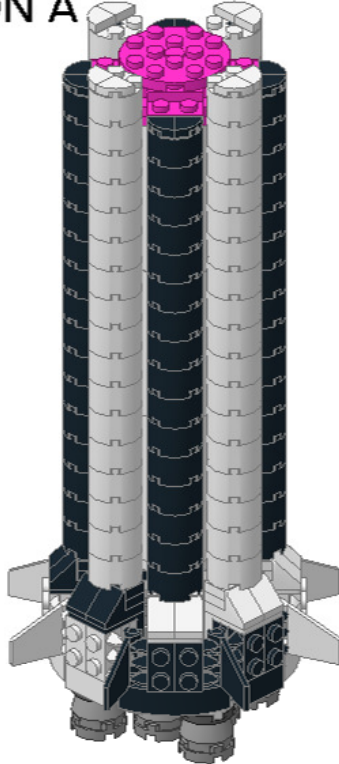
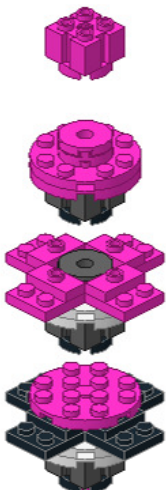

12

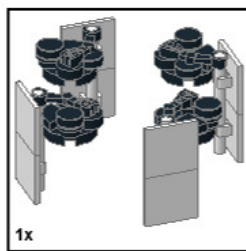

1x

1



4x

2



4x

4x

3



4x

4x

4

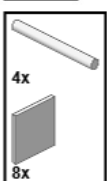



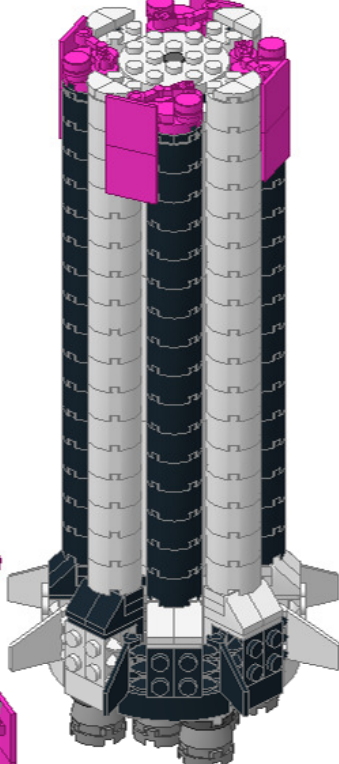

4x

8x

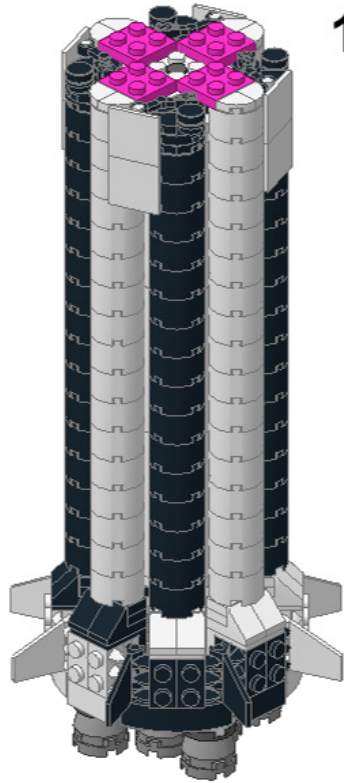



13  4x

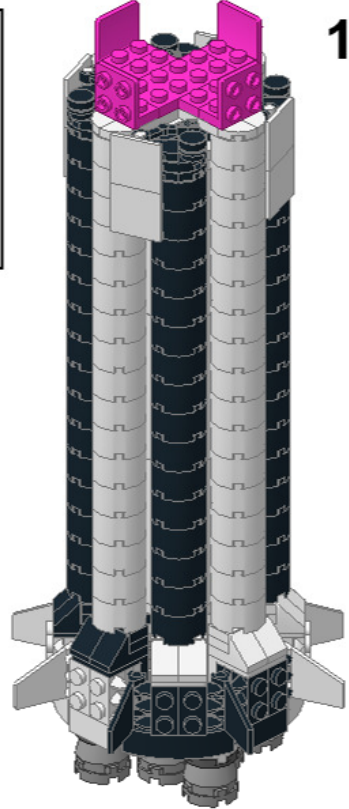

14  2x  
 4x  
 1x



15  2x  
 2x

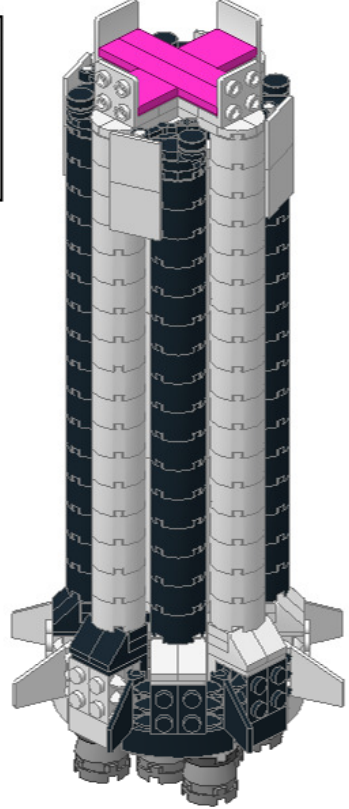

SECTION A

16

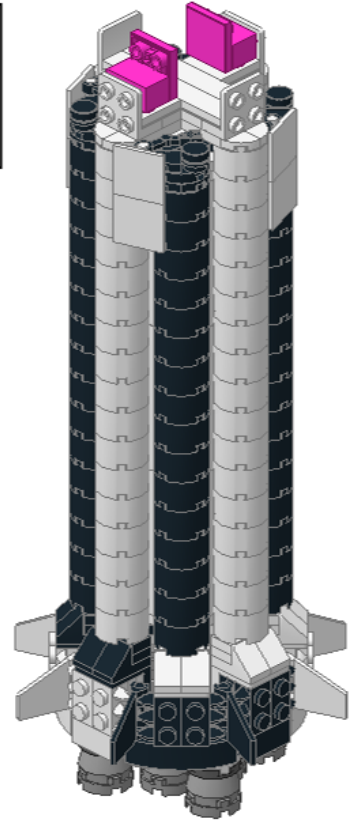
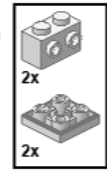

SECTION A

1

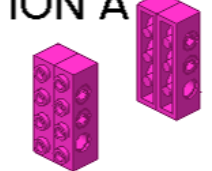
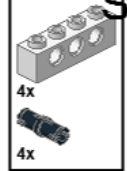

2

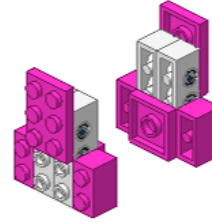
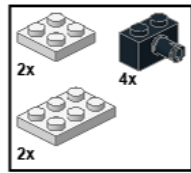

3

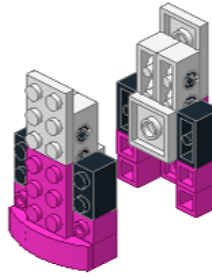
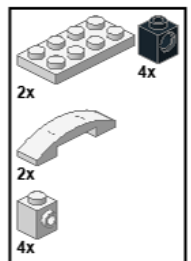

4

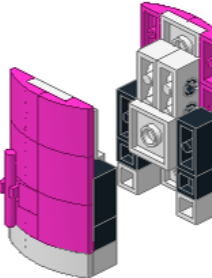
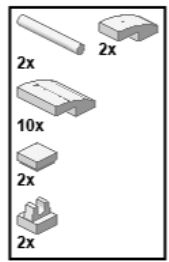

5

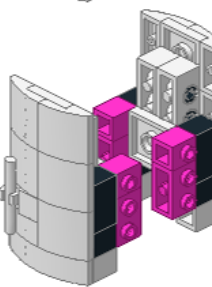
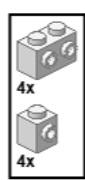

6

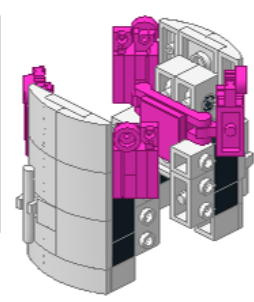
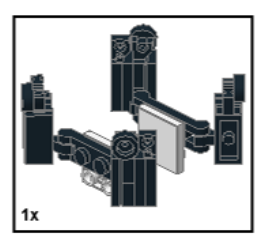

1

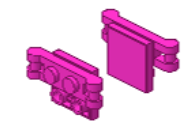
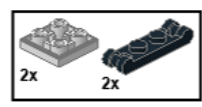

2

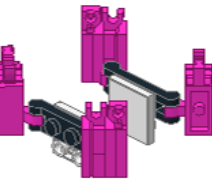
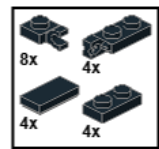

3

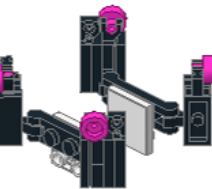

17

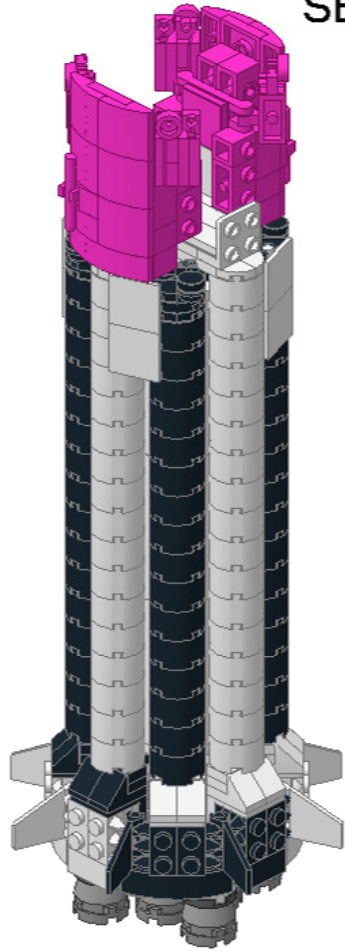
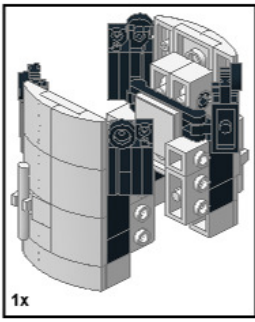

SECTION A

18

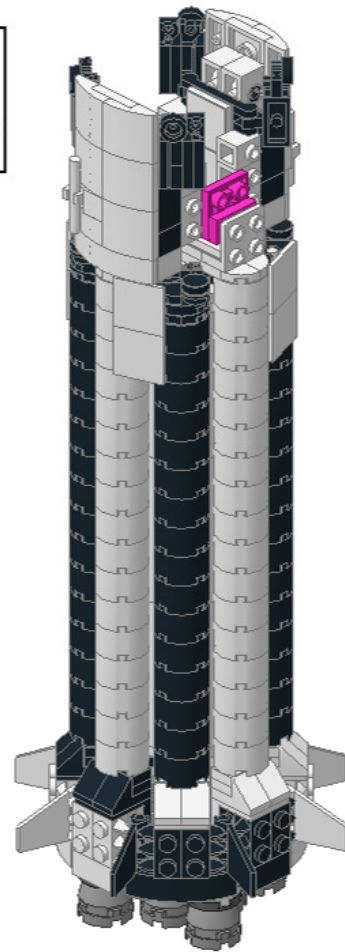
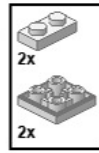

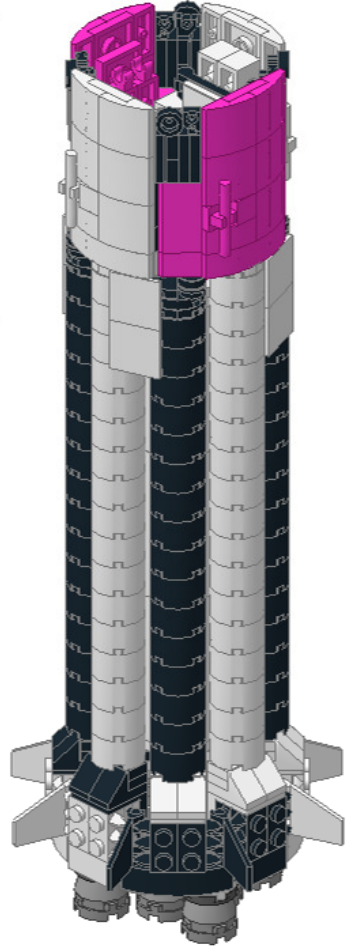
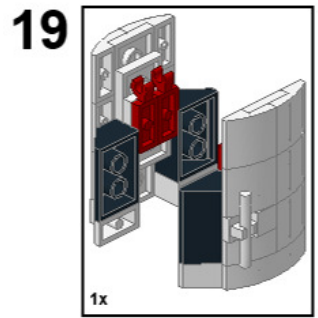
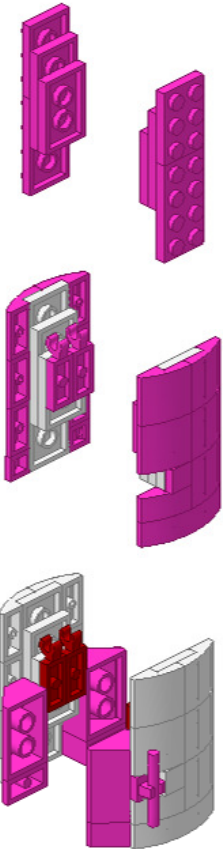
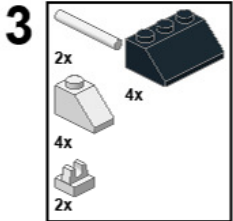
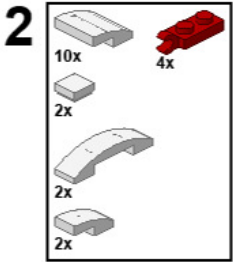
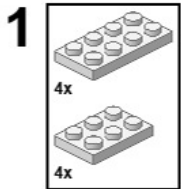

SECTION A

# SECTION A

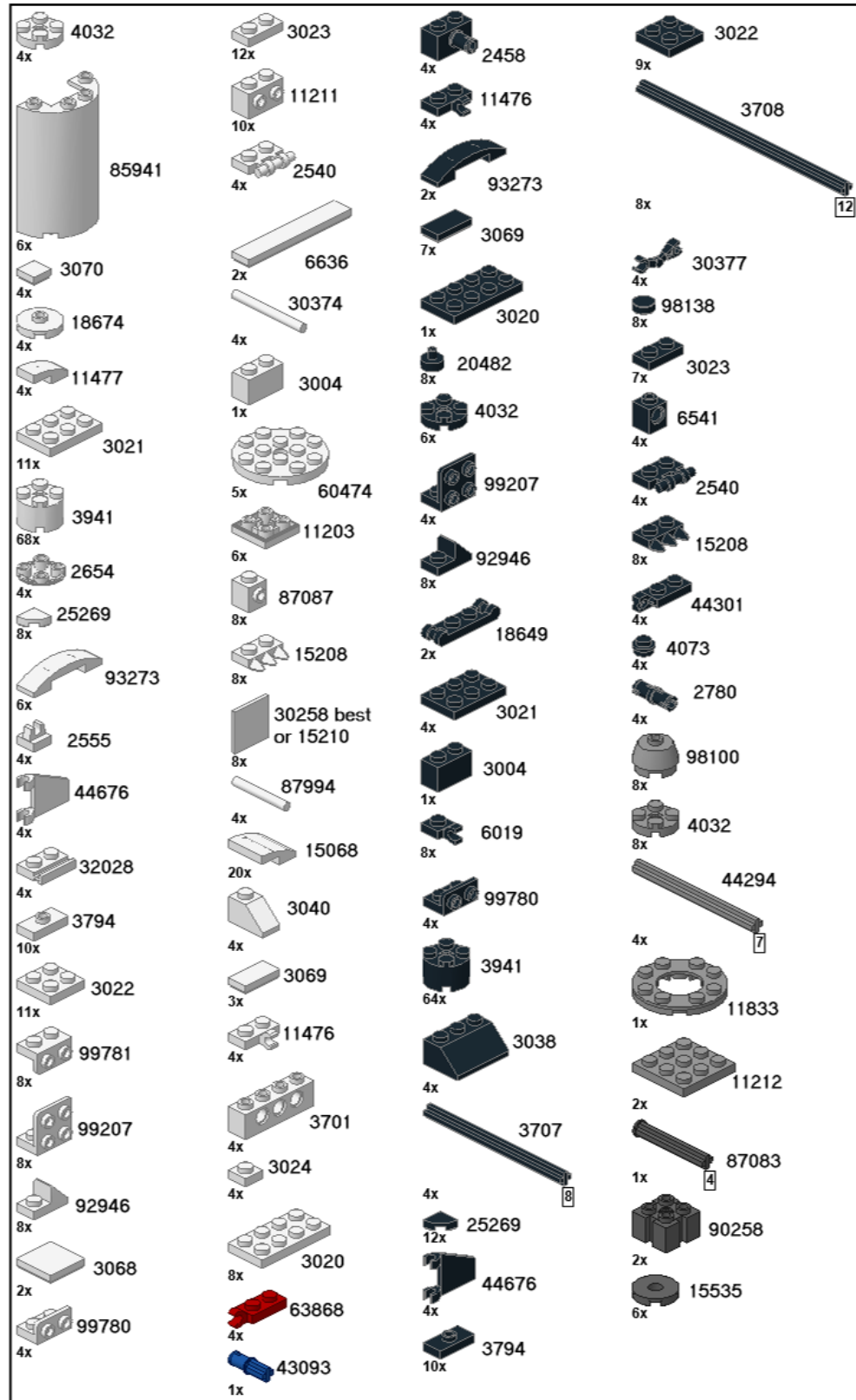

# SECTION B

1

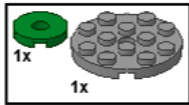

2

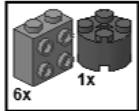

3

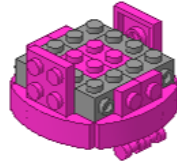
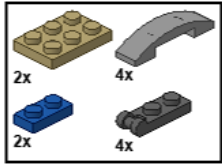

4

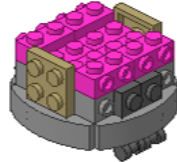
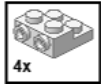

5

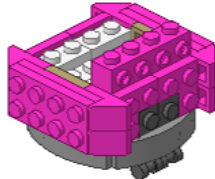
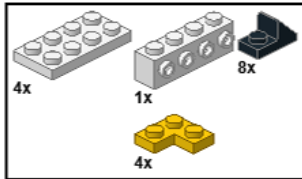

6

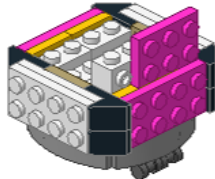
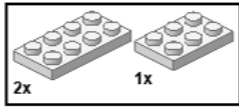

7

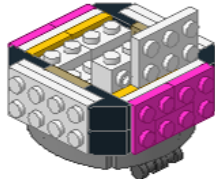

8

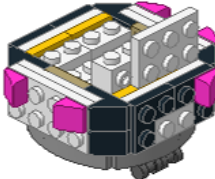

9

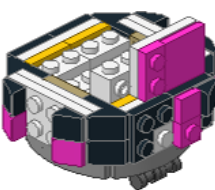
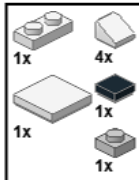

10

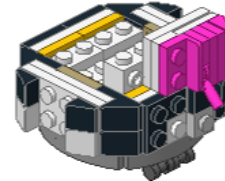
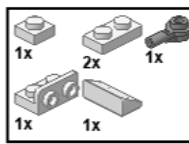

11

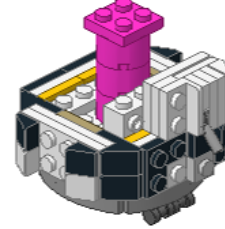

12

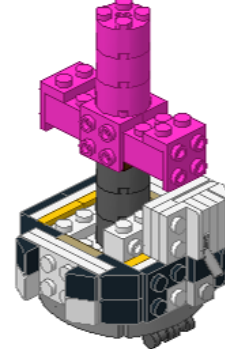
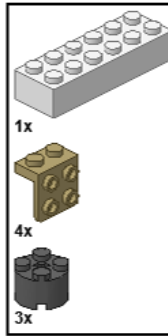

13

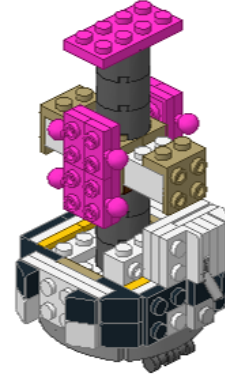
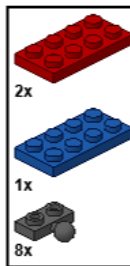

14

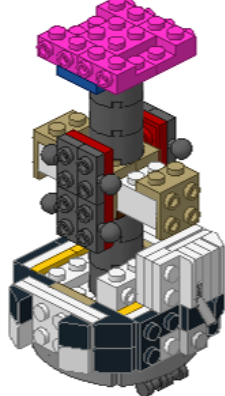



15

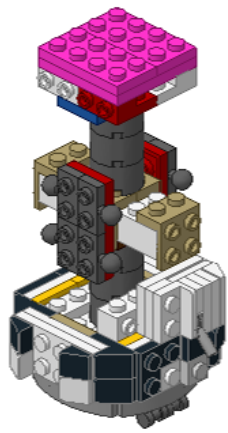
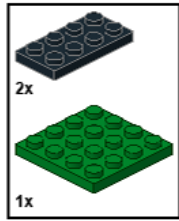

16

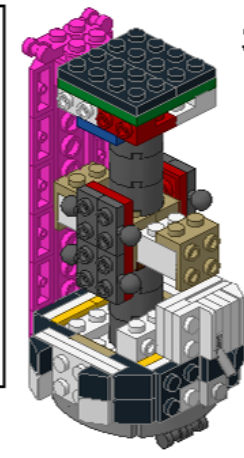
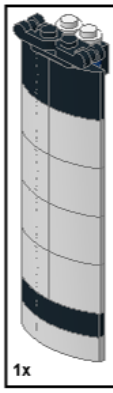

SECTION B

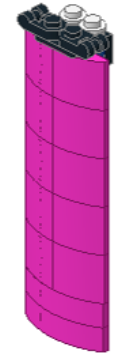
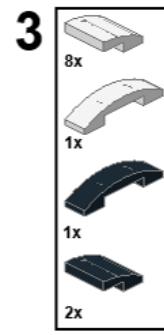
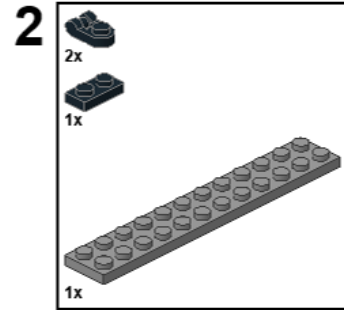
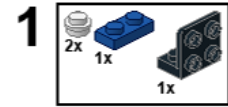



18

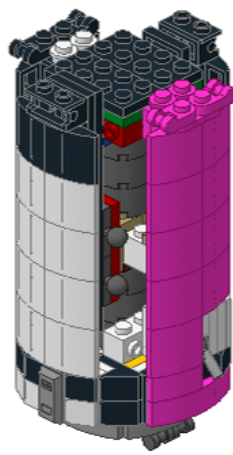
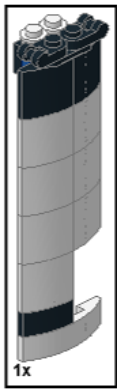

SECTION B

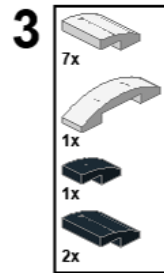
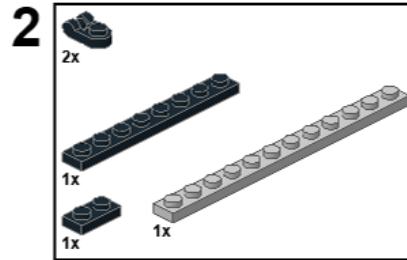
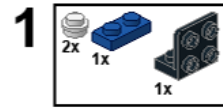

19

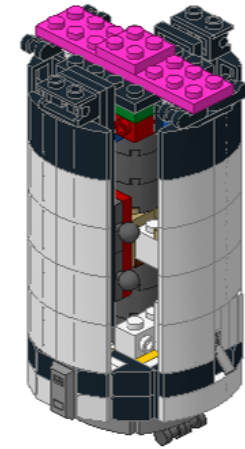
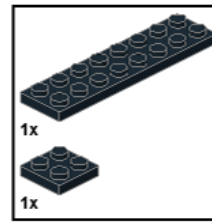

20

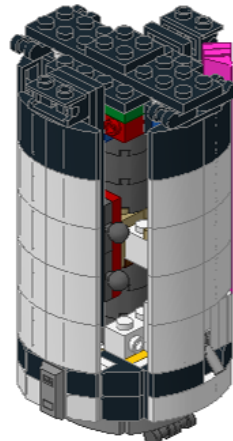
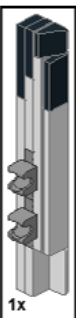

1

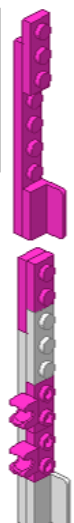
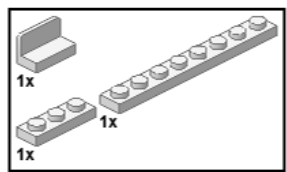

2

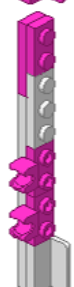
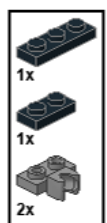

3

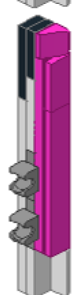
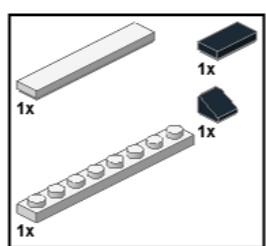

SECTION B

21

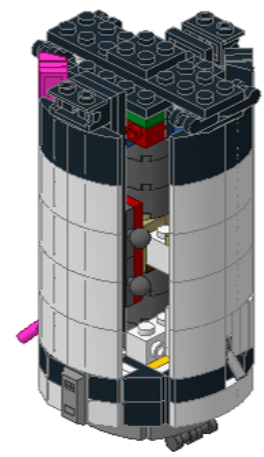
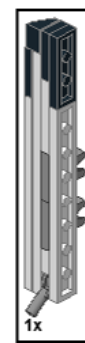

1

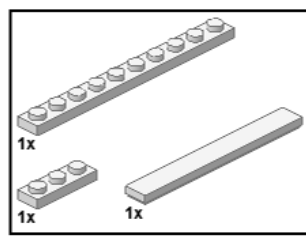

2

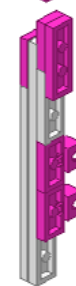
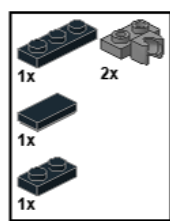

3

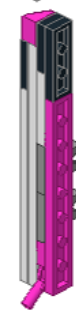
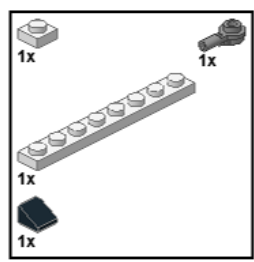

22

1

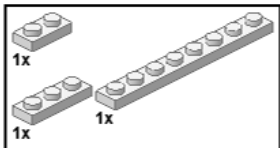

2

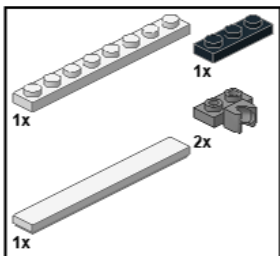

3

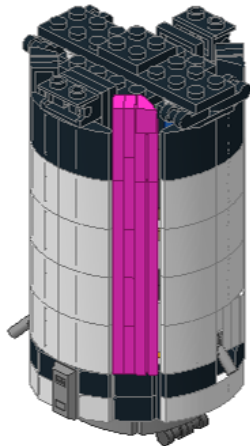
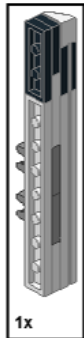
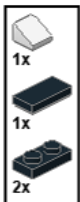

SECTION B

23

1

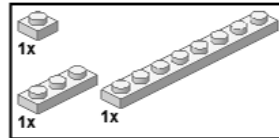

2

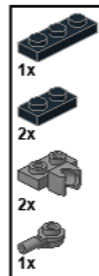

3

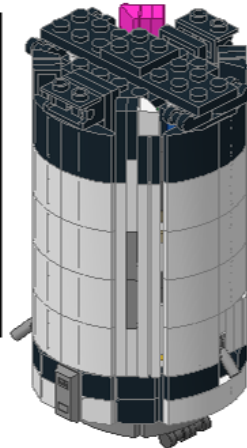
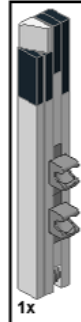
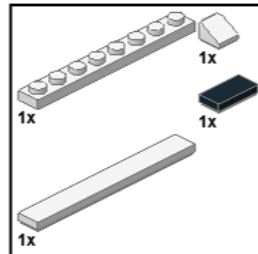

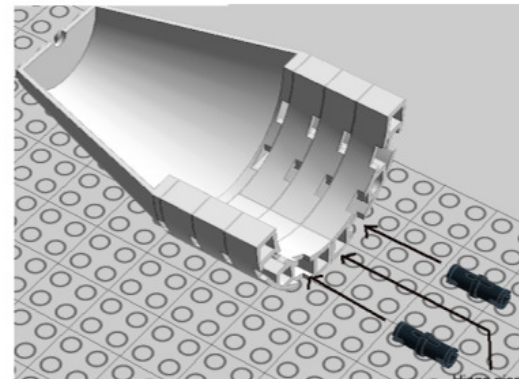
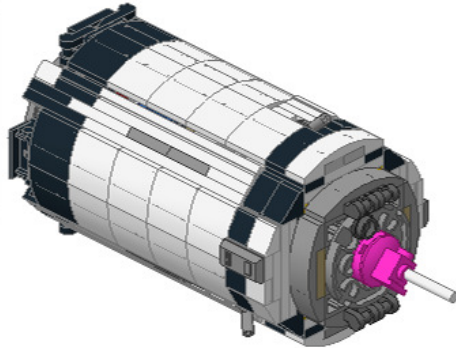
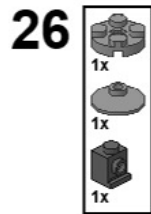
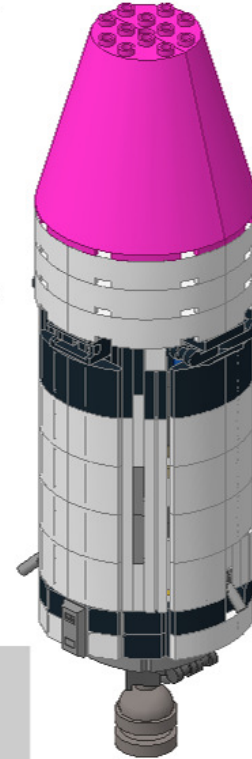
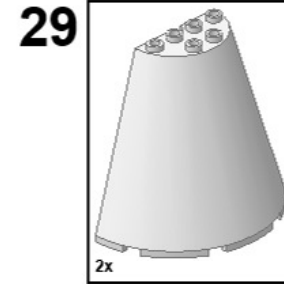
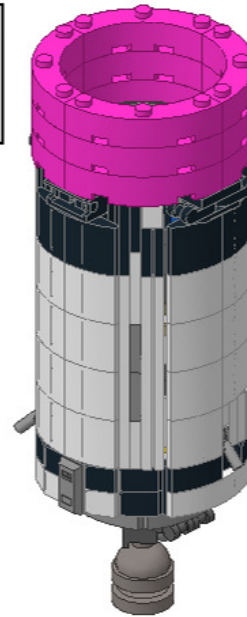
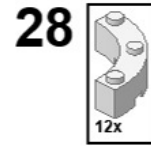
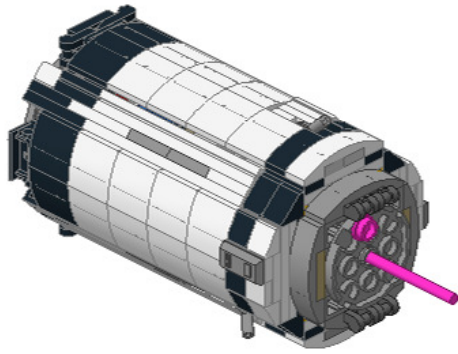
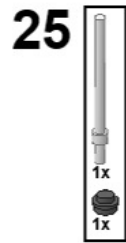
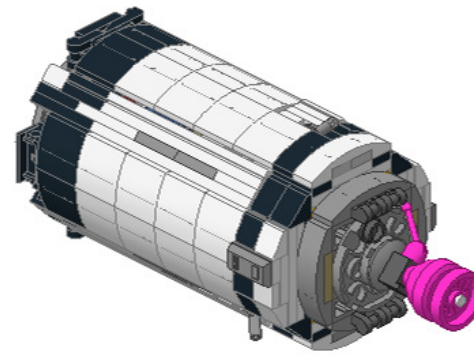
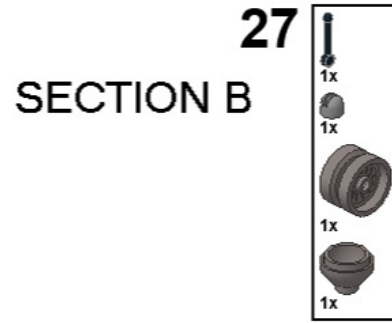
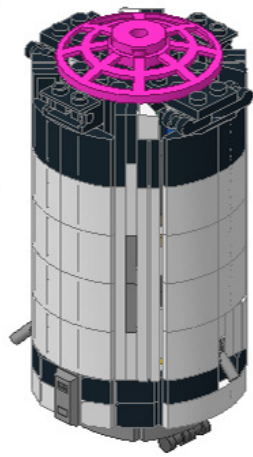
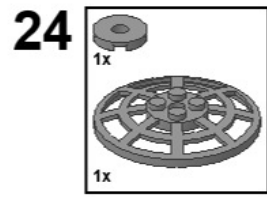



Pegs go into here, but tricky to get right. Stick in, keep pressure on it and twist till resistance.

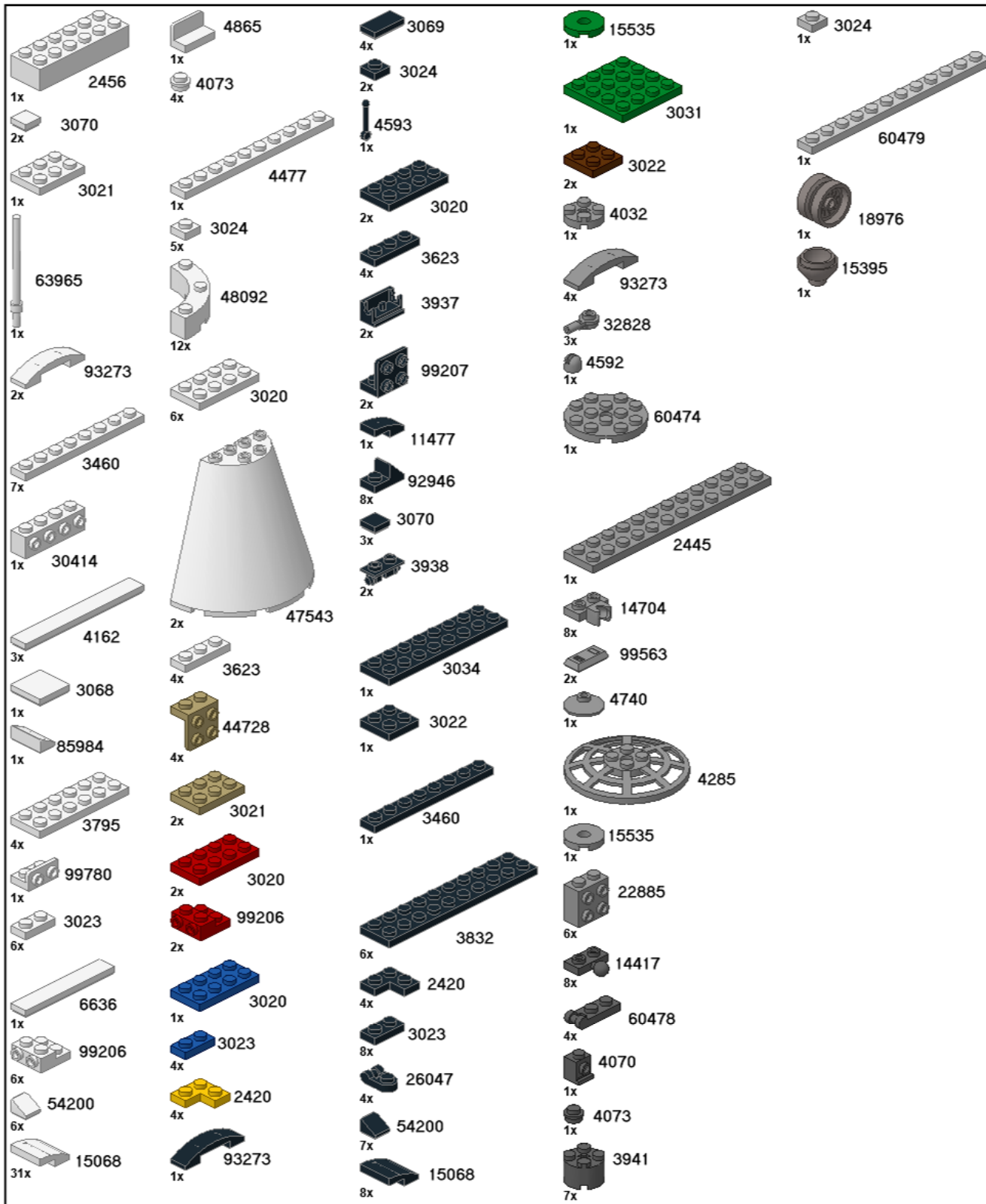

Hinge pieces attach here.



# SECTION B

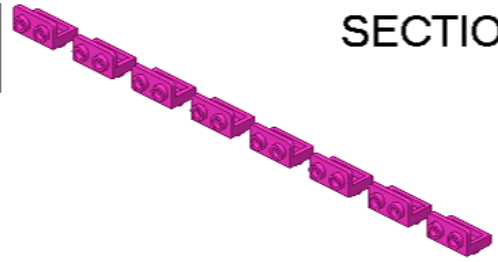



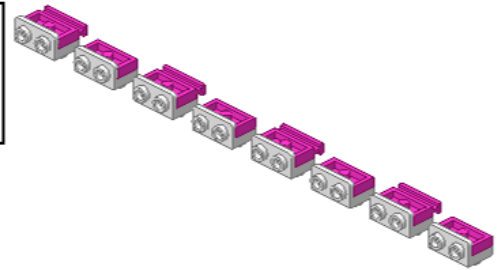

# SECTION C

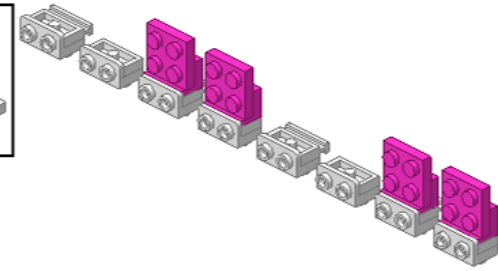

**1**  8x 

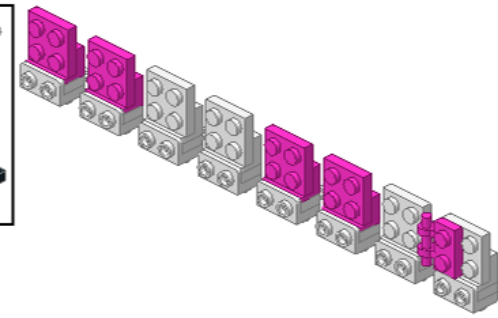
**2**  4x  4x 

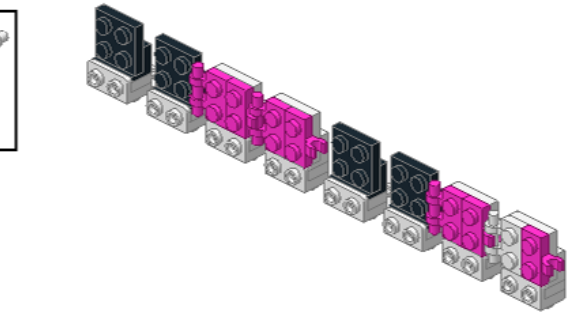

**3**  4x  4x 

**4**  1x  4x  4x 

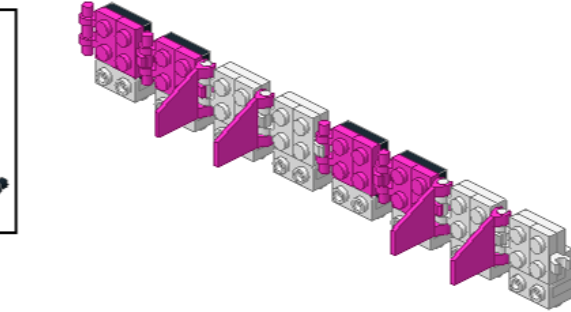
**5**  3x  4x 

**6**  4x  4x  4x 

**7**  4x  4x 

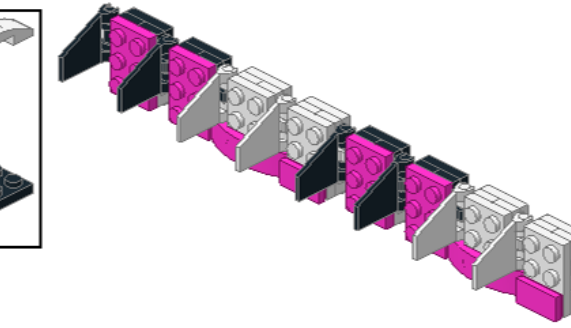
**8**  2x  2x  4x 



# SECTION C 12

9

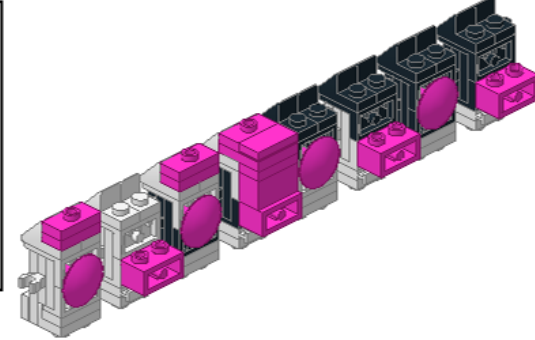
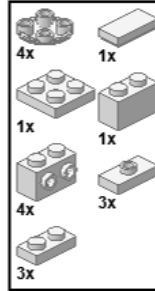
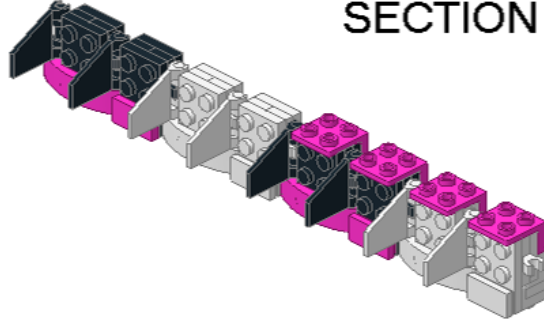
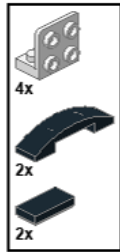

10

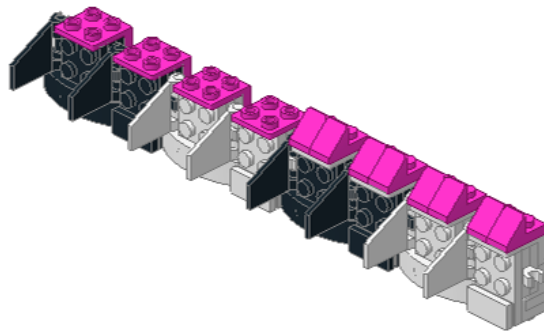
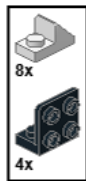

13

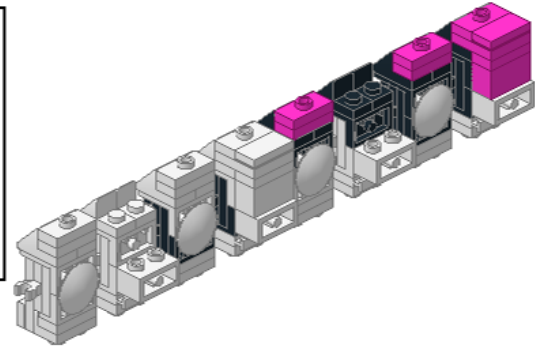
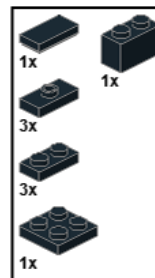

11

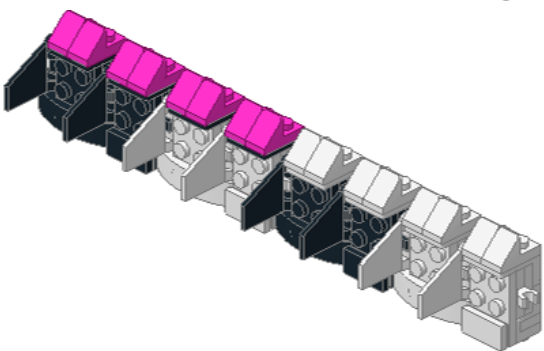



5

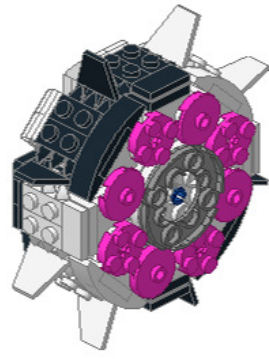
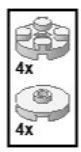

SECTION C

8

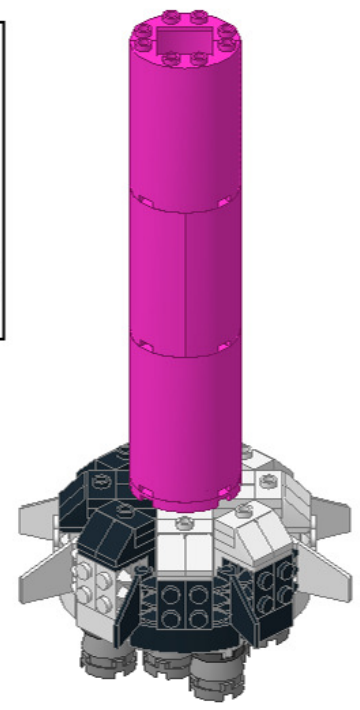
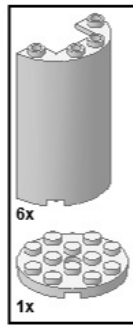

6

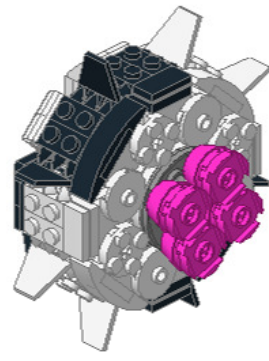
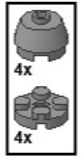

7

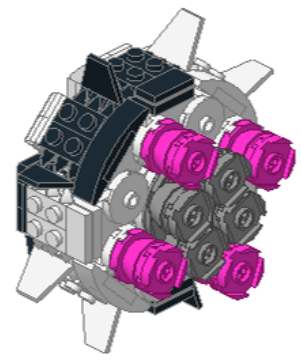
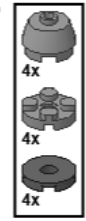

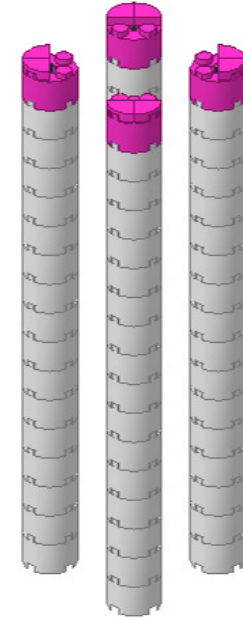
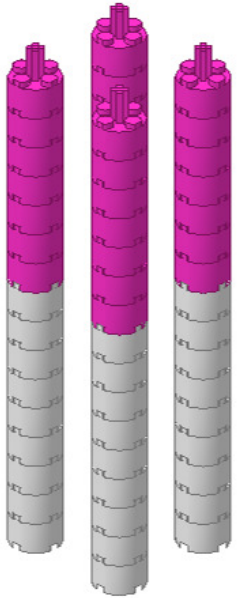
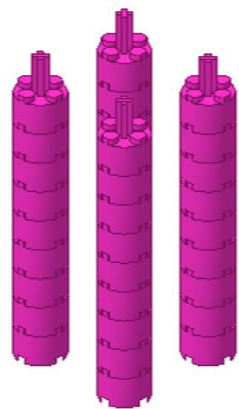
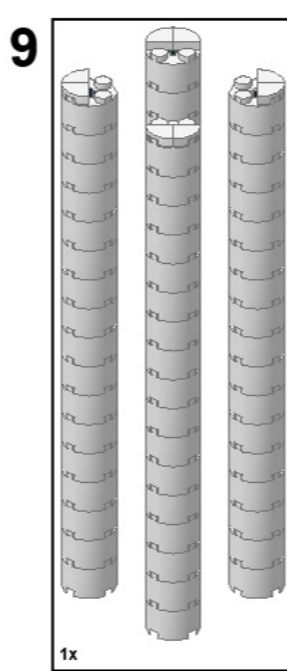
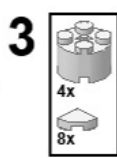
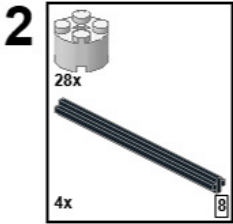
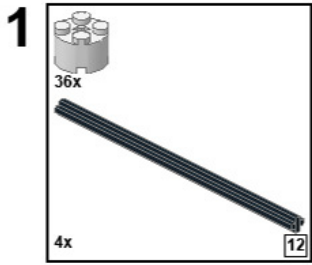

SECTION C

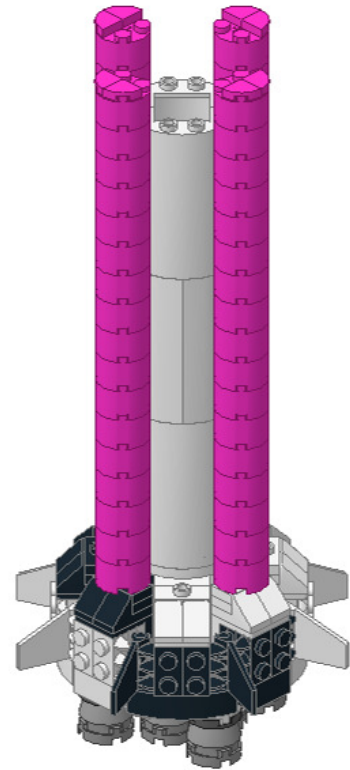

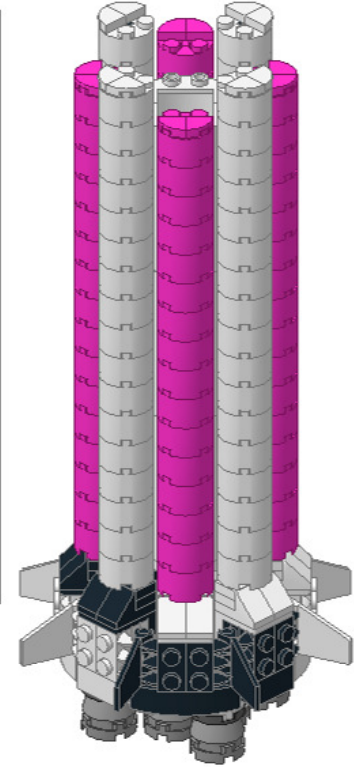
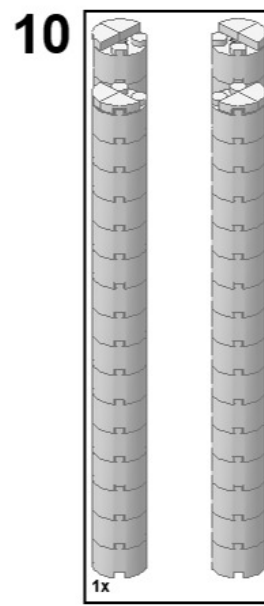
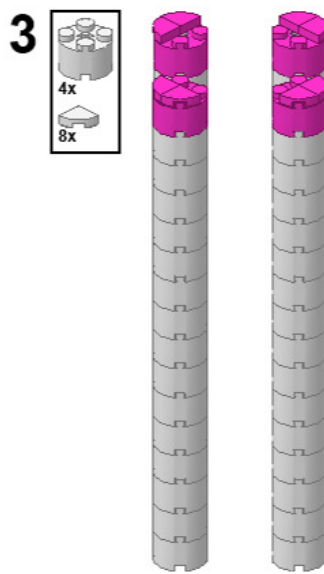
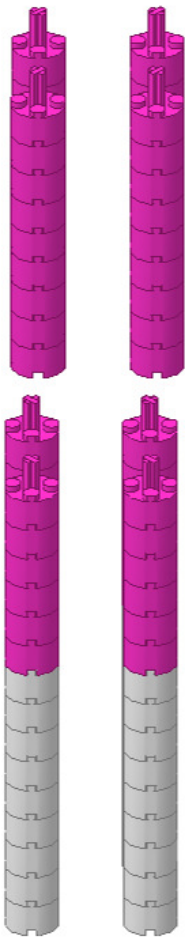
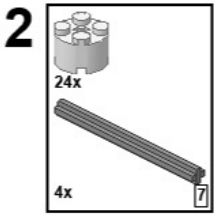
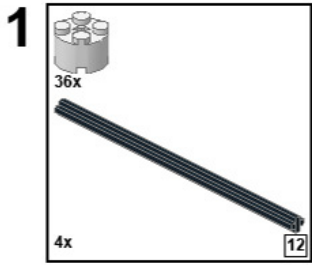

SECTION C

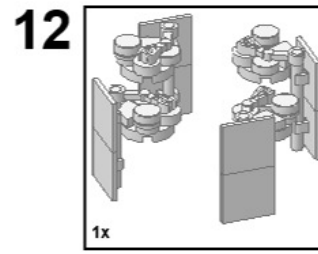
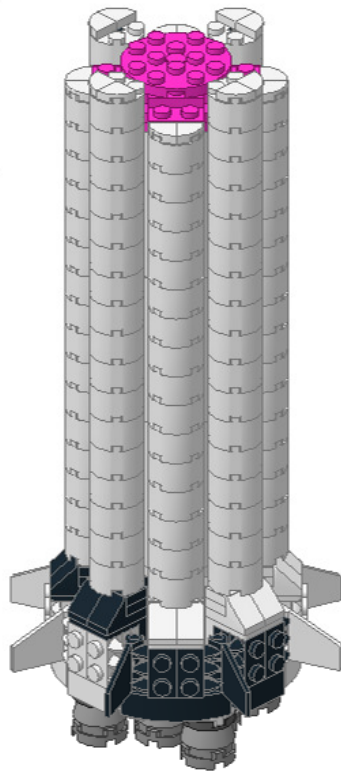
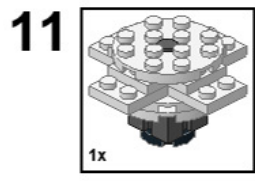

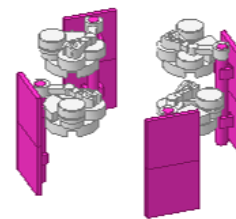
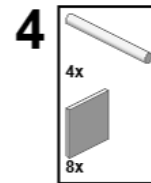
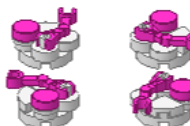
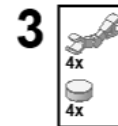
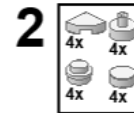
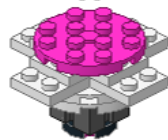
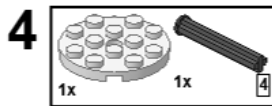
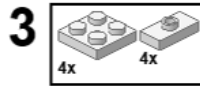
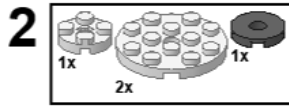
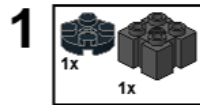
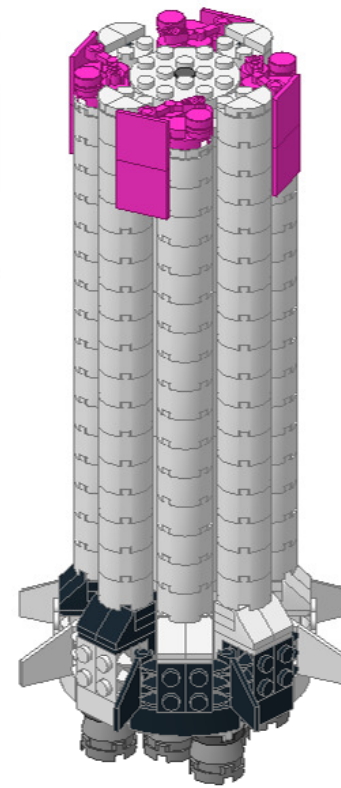

SECTION C



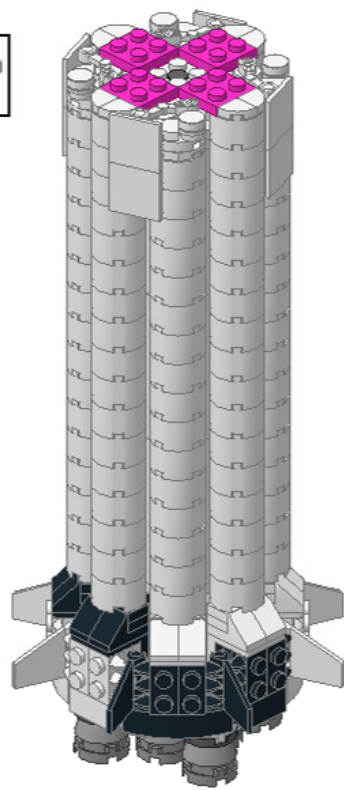

13  4x

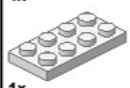

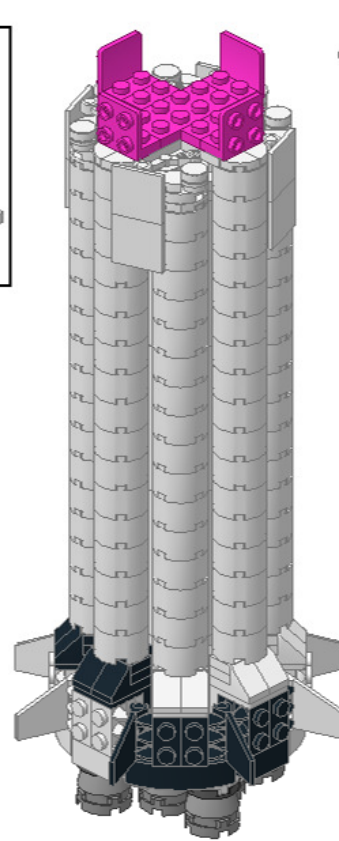
14  2x  
 4x  
 1x



15  2x  
 2x

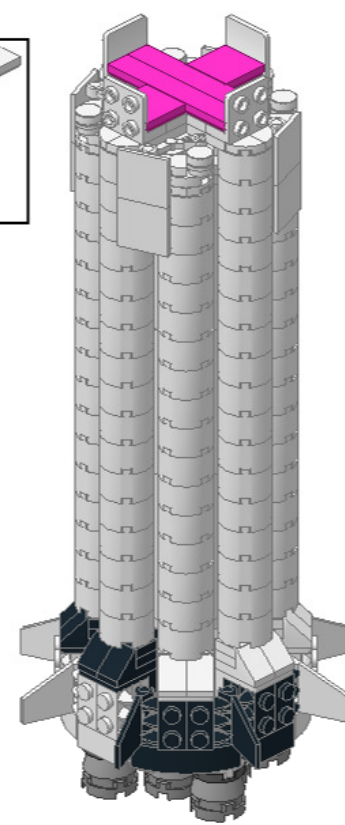

SECTION C

16

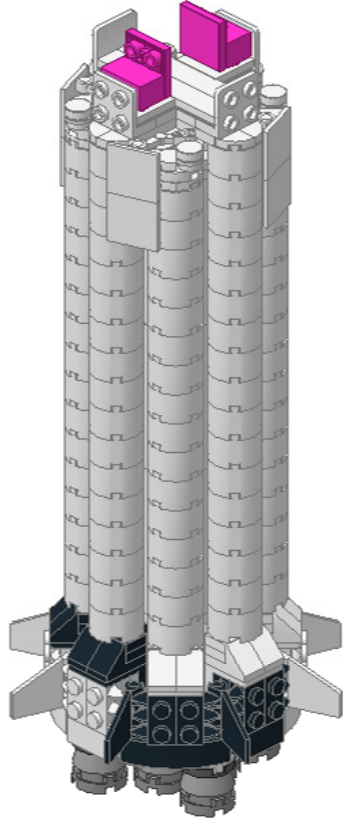
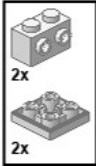

1

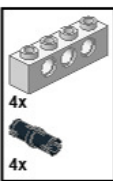

2

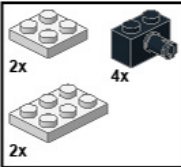

3

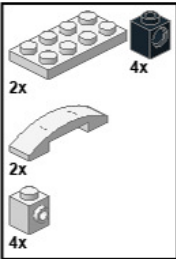

4

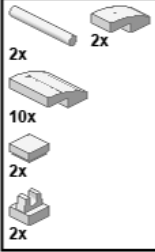

5

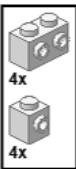

SECTION C

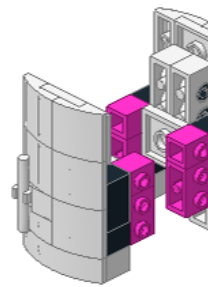
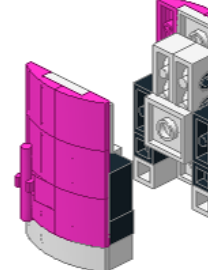
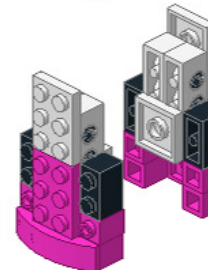
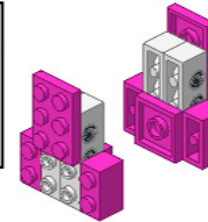

1

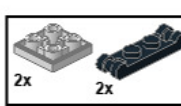

2

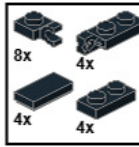

3



6

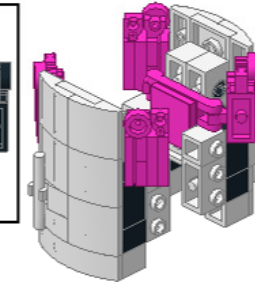
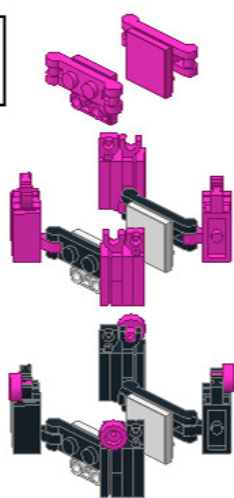
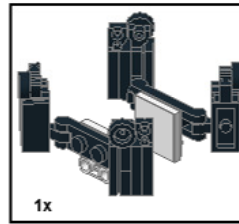



17

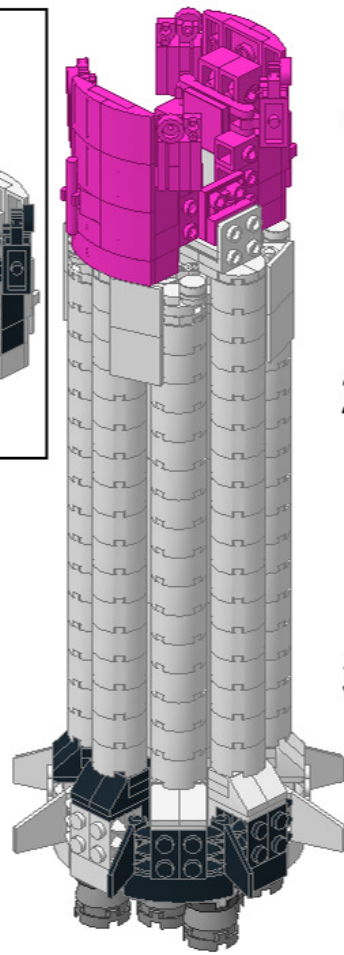
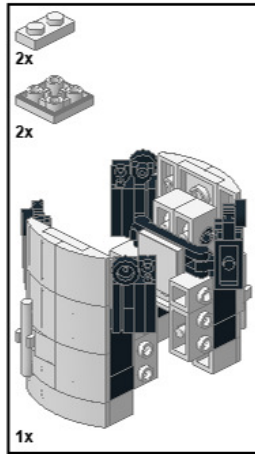

SECTION C

1

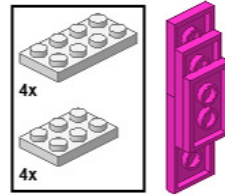

2

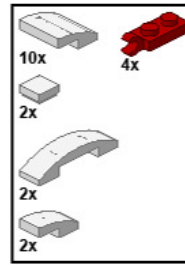

3

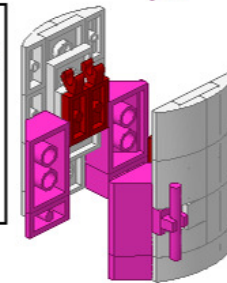
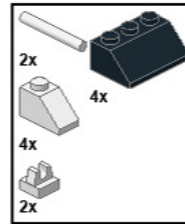

18

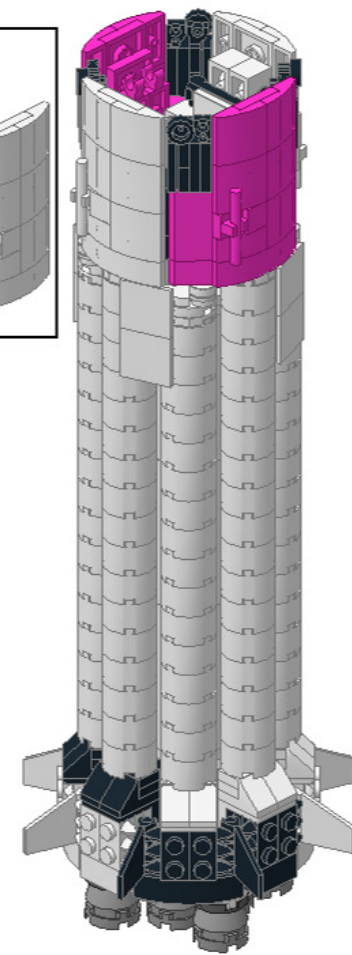
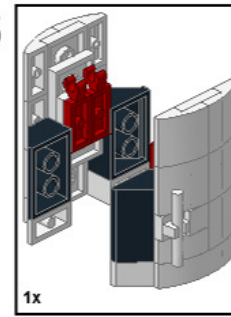

# SECTION C

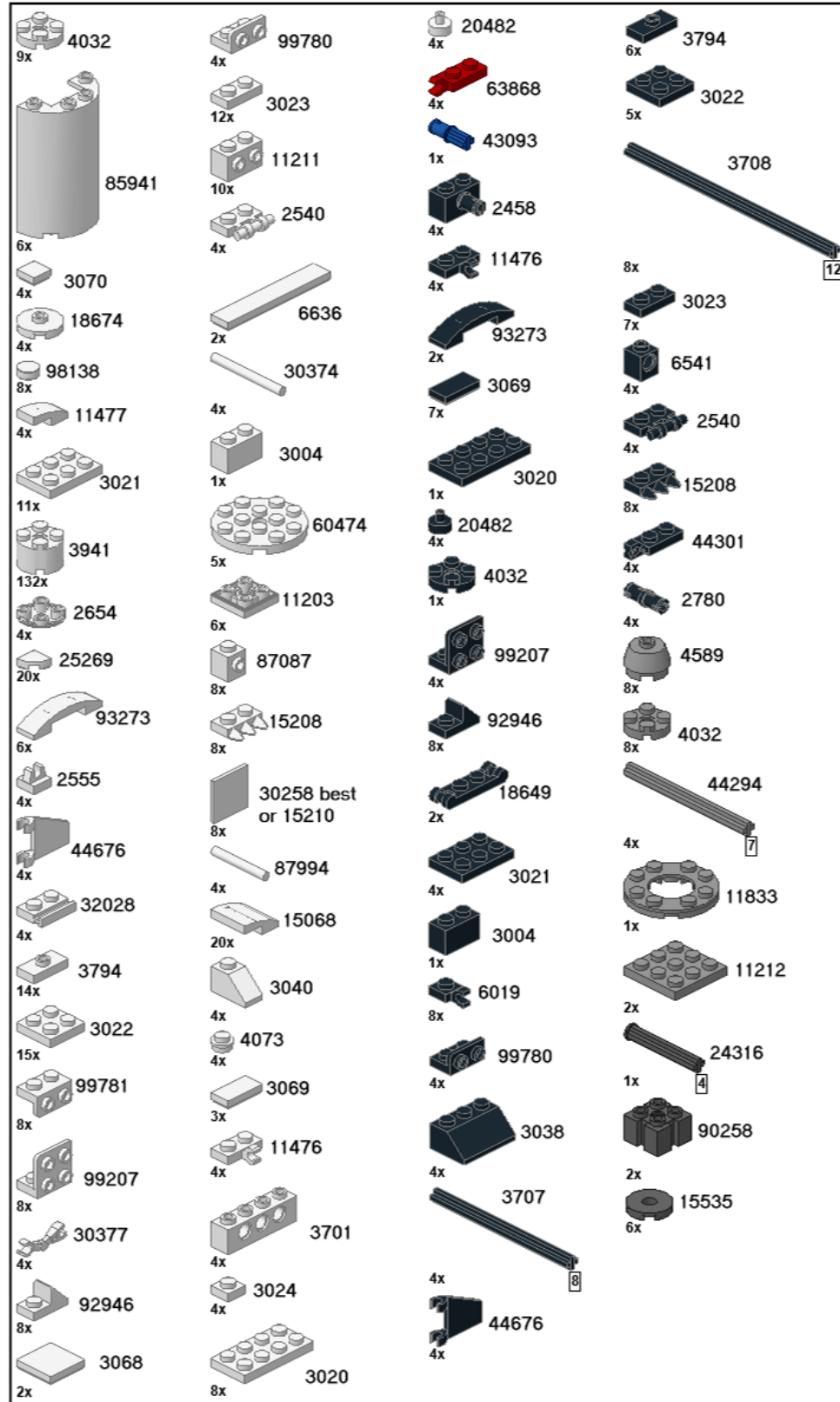

1

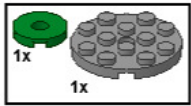

SECTION D

10

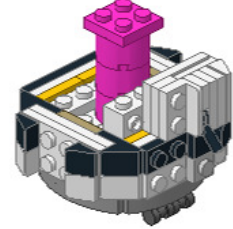
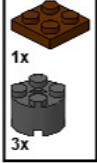

2

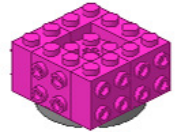
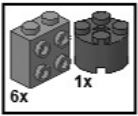

3

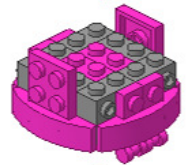
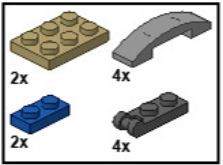

4

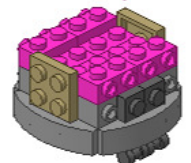

11

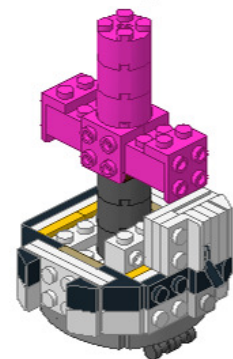
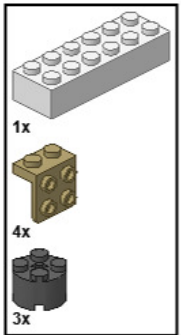

5

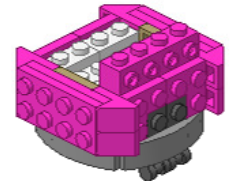
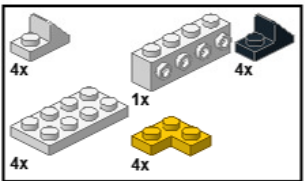

12

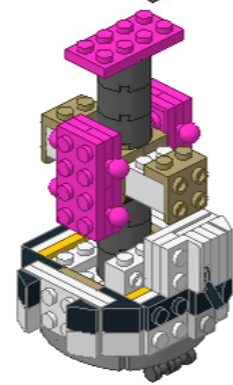
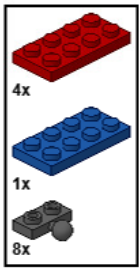

6

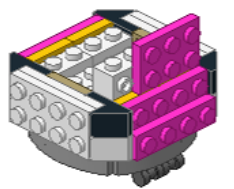
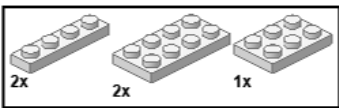

7

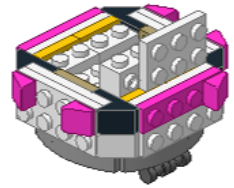
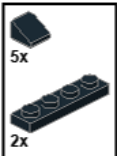

13

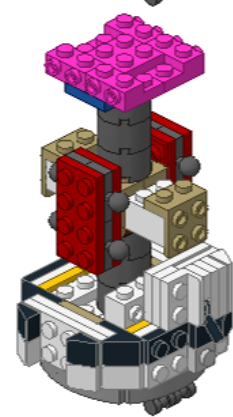

8

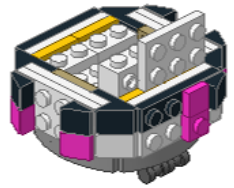

9

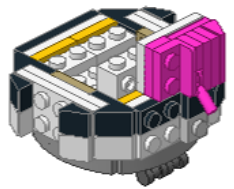
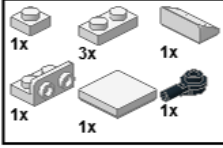

14

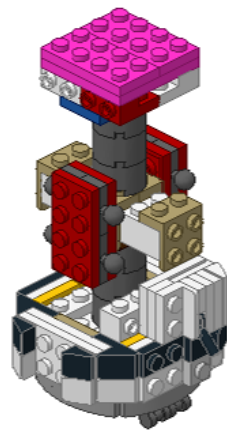
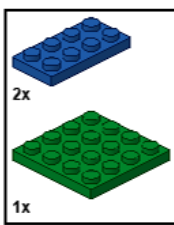

15

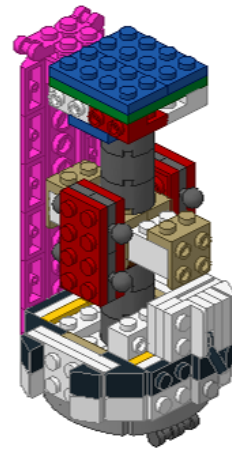
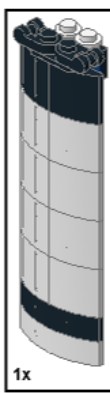

SECTION D

1

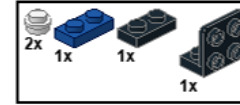

2

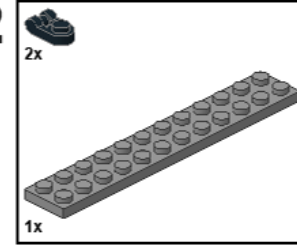

3

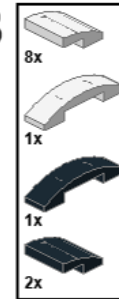

16

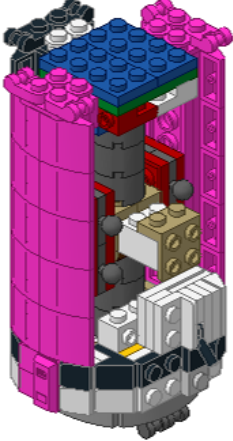
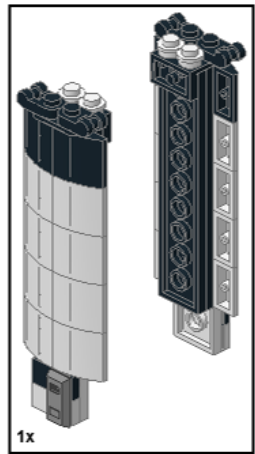

SECTION D

- 1
- 4x [grey 1x1 pin]
  - 4x [black 1x2 Technic brick]
  - 2x [black 1x2 Technic brick with hole]

- 2
- 4x [grey 1x6 Technic brick]
  - 4x [black 1x12 Technic brick]

- 3
- 2x [grey 1x2 Technic brick]
  - 16x [grey 1x2 Technic brick]
  - 2x [grey 1x2 Technic brick]

- 4
- 2x [black 1x2 Technic brick]
  - 4x [black 1x2 Technic brick]
  - 2x [black 1x2 Technic brick]

- 5
- 2x [grey 1x2 Technic brick]

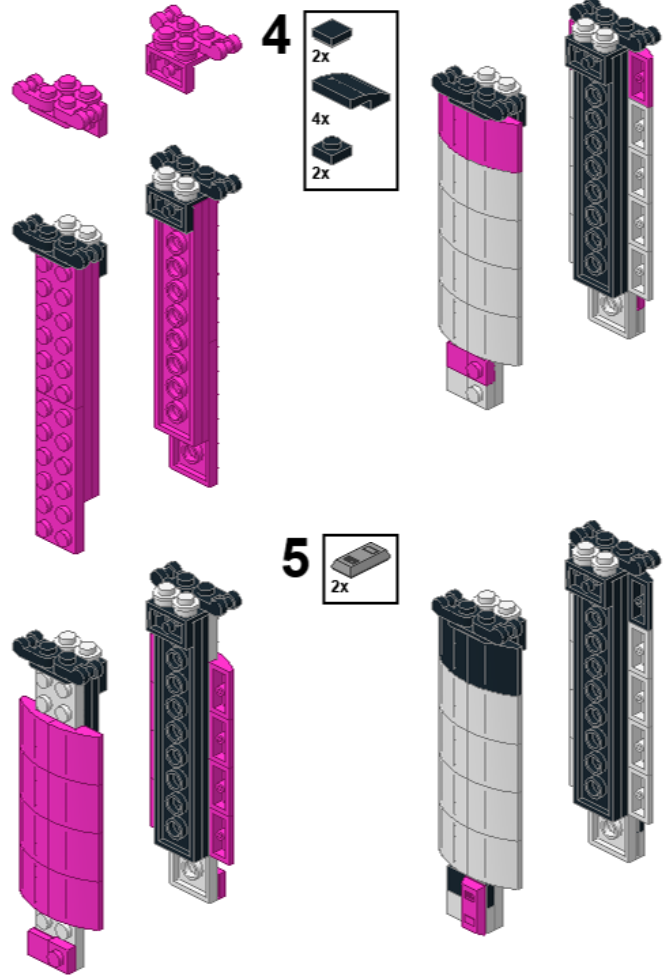

17

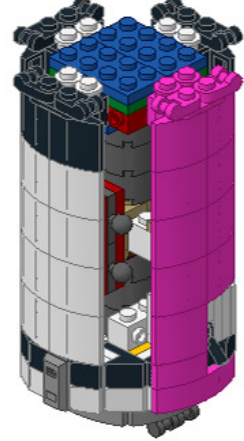
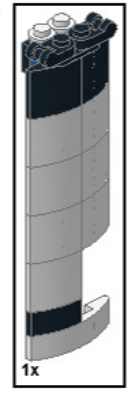

SECTION D

1

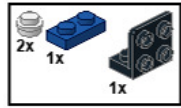

2

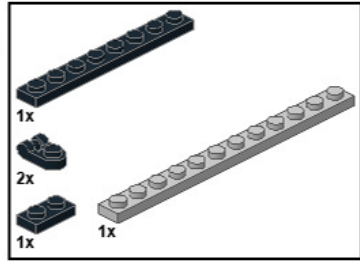

3

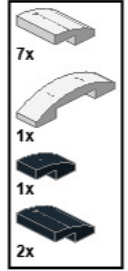

18

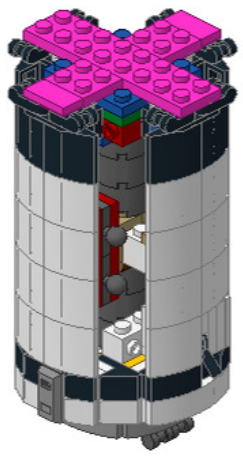
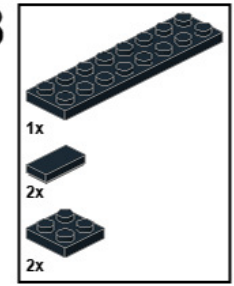

19

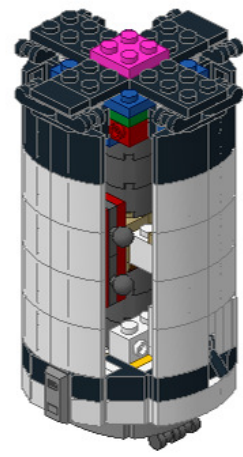

20

SECTION D

21

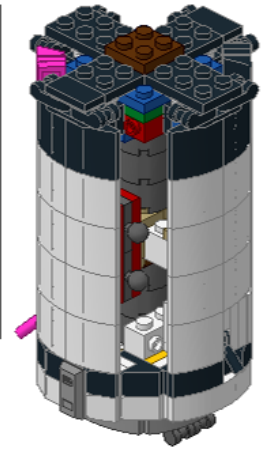
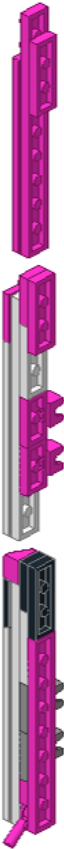
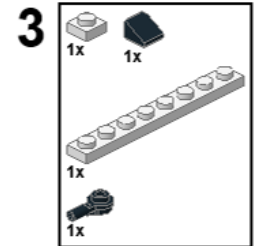
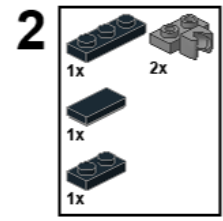
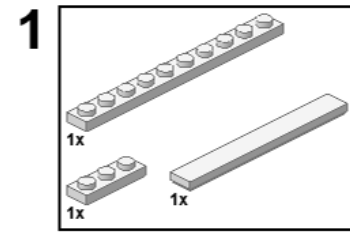
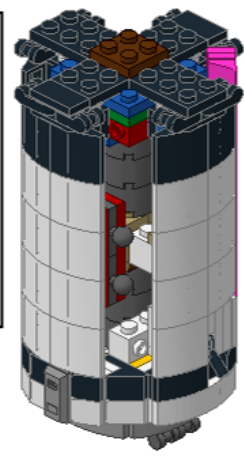
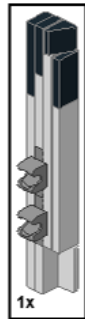
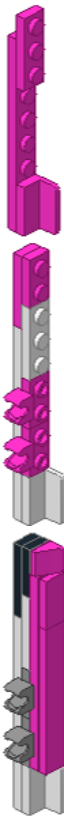
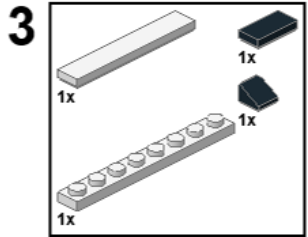
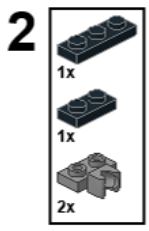
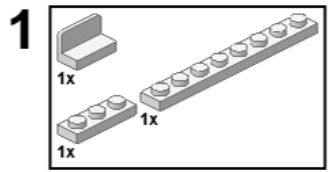

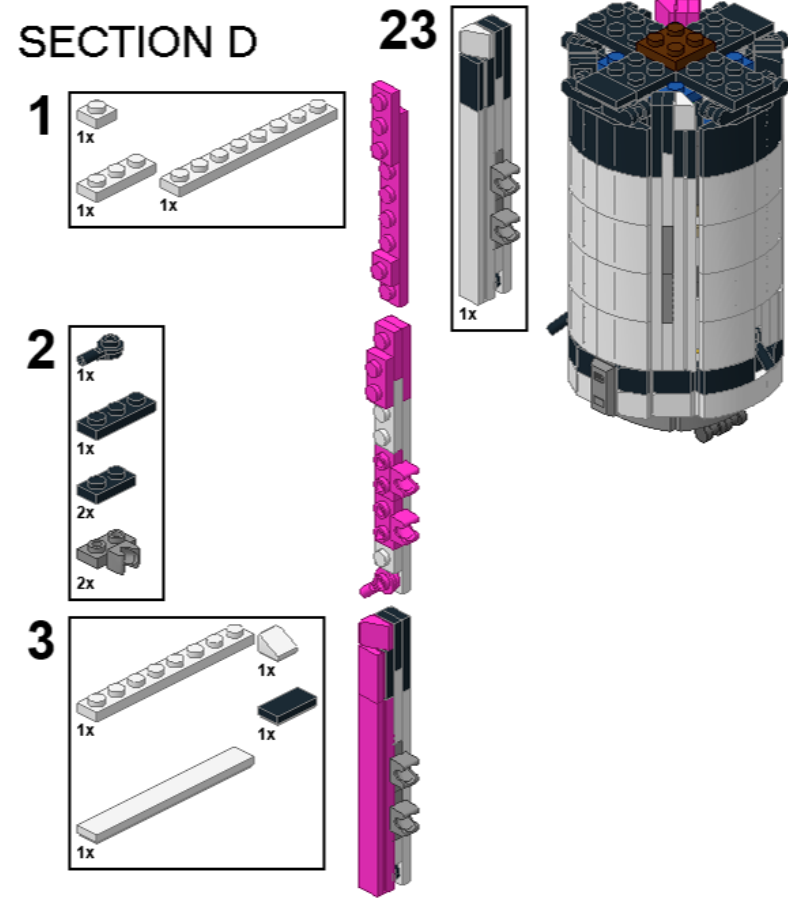
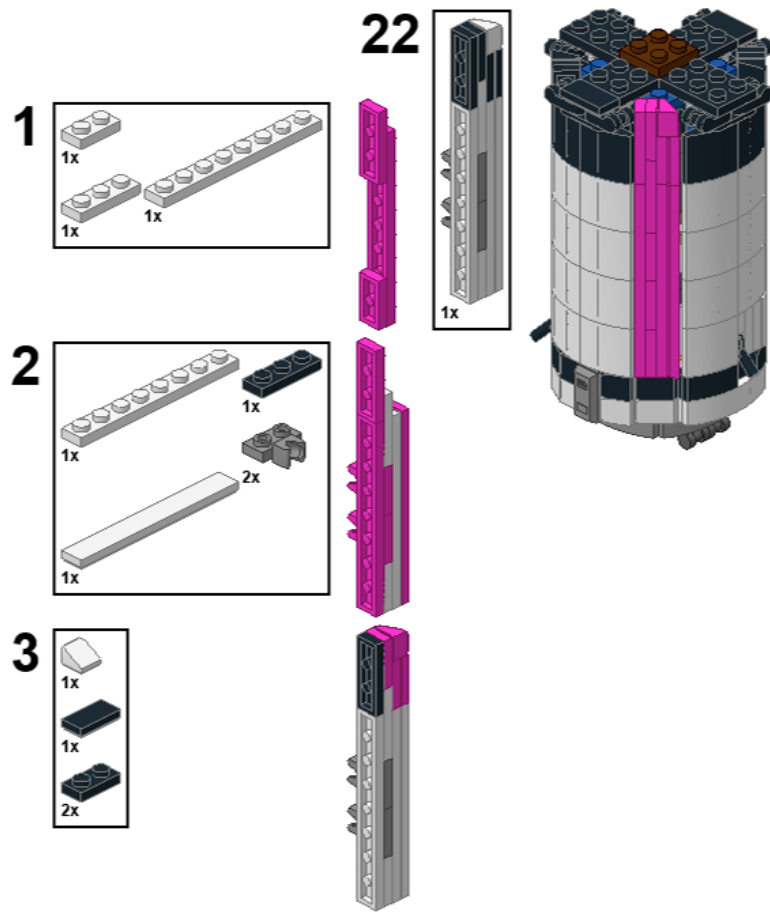



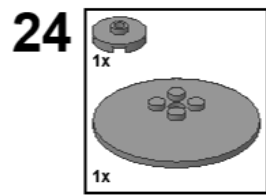

**SECTION D**

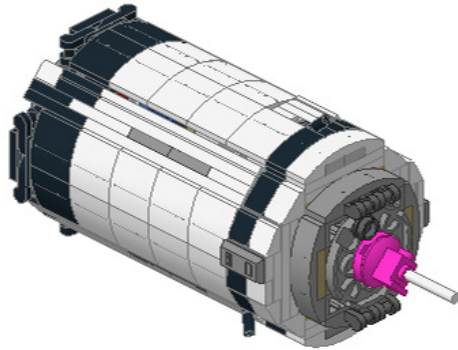
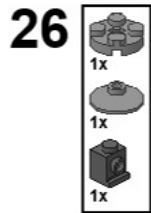
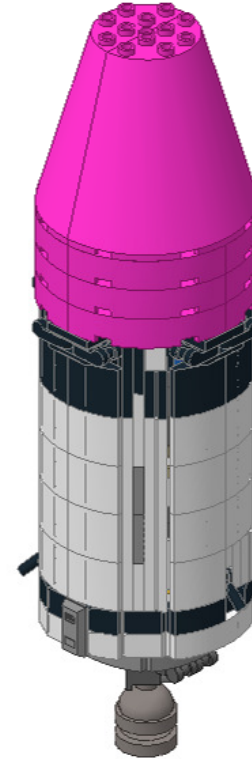
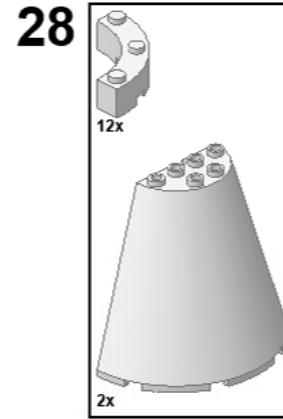
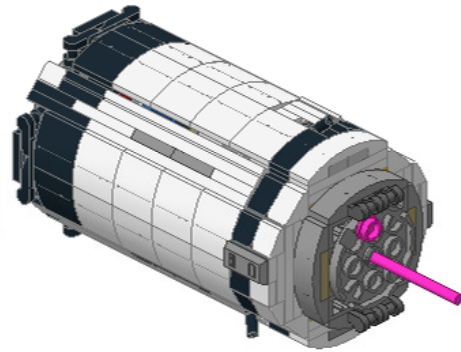
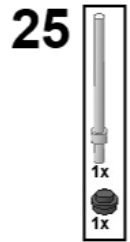
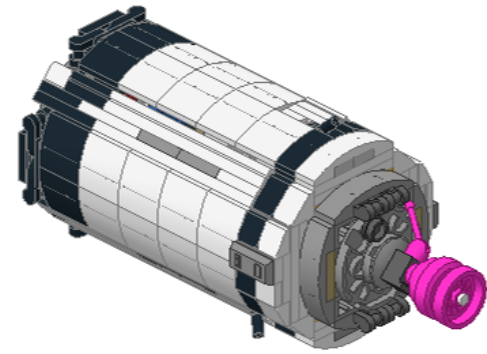
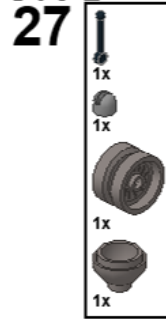

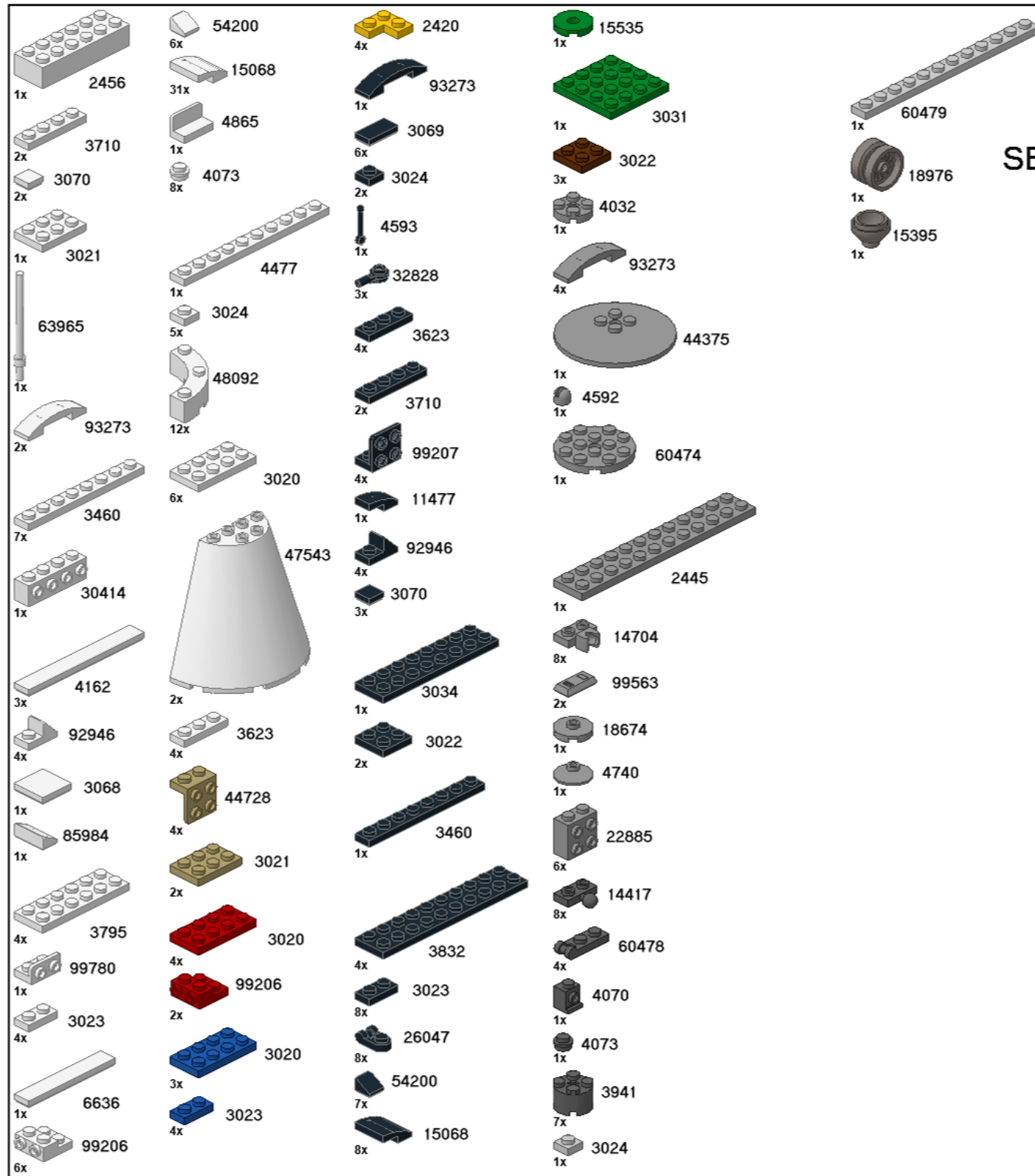

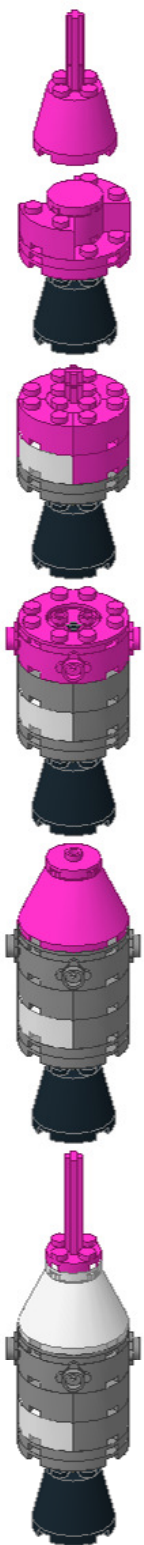
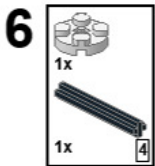
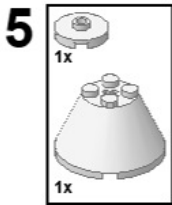
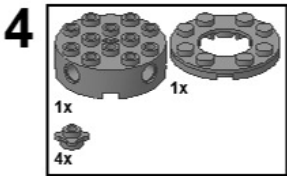
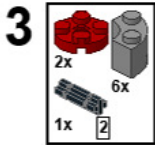
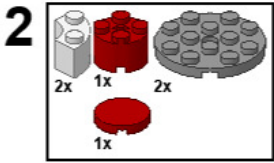
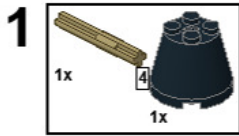

**SECTION E**

